

Makita[®]

Catálogo de
ACESSÓRIOS
2022



HISTÓRIA

A Makita tornou-se um dos principais fabricantes mundiais de ferramentas elétricas portáteis, com 11 fábricas em todo o mundo e um grande número de subsidiárias. Com uma seleção de mais de 700 modelos de qualidade superior e fabricados com a mais avançada tecnologia, a Makita oferece a mais vasta gama de ferramentas elétricas.

Em março de 1915, Mosaburo Makita fundou a MAKITA ELECTRIC WORKS na cidade de Nagoya, uma loja especializada na venda e reparação de motores elétricos e transformadores.

Em 1989 foi fundada a Makita España, S.A. e, em novembro de 1991, mudou o seu nome para Makita, S.A.

Em 2009 foi fundada a Makita Portugal.

Ao longo dos anos, a empresa inicial passou por várias transformações:

- 1915 É fundada a Makita Electric Works na cidade de Nagoya. Começou por vender e reparar equipamentos elétricos, motores e transformadores.
- 1958 Teve início a comercialização de plainas elétricas, o primeiro produto no Japão. 
- 1969 Berbequim a bateria 6500D (a primeira ferramenta a bateria). 
- 1978 Lançamento do berbequim a bateria modelo 6010D (primeira ferramenta a bateria de Ni-Cd). 
- 1981 Lançamento da pregadora pneumática AN5000 e do compressor de ar AC6001 (primeiras ferramentas pneumáticas).  
- 1989 Três ferramentas elétricas (serra circular, rebarbadora, berbequim) desenhadas por Giorgetto Giugiaro são expostas na Exposição Mundial de Design a cidade de Nagoya. 

- 1989 É fundada a Makita España S.A (designação alterada para Makita, S.A. em 1991). 

- 1991 Aquisição da Sachs Dolmar GmbH, fabricante alemão de motosserras (designação alterada para Dolmar GmbH em 1991)

- 1991 Chega a segunda marca, MAKTEC. 

- 1997 Berbequim aparafusador a bateria 6213D, exposto no salão de ferragens de Chicago (primeira ferramenta a bateria Ni-MH). 

- 2005 Chegam os modelos LTD130E (primeiras ferramentas a bateria de íões de lítio). 

- 2007 A Fuji Robin Industries Ltd. torna-se uma subsidiária consolidada. (muda o seu nome para Makita Numazu Corporation em agosto de 2007)

- 2015 Comemoração do 100.º aniversário. 

- 2019 30.º ANIVERSÁRIO MAKITA S.A. 

- 2020 Nasce a gama XGT, um novo sistema com as suas próprias ferramentas, baterias e carregadores. Uma combinação de ferramentas inovadoras. O design e as baterias mais potentes oferecem uma verdadeira solução para utilizadores industriais de alta procura.



- 2022 Chegámos onde não se esperava e lançámos uma série de modelos dedicados ao "Ar Livre"



Makita - Marca Global

A Makita estabeleceu bases comerciais em cerca de 50 países em todo o mundo.

A rede mundial de produtos e serviços da Makita, assim como a qualidade estável e de elevada produção assegurada.

Além disso, a Makita produz ferramentas elétricas em fábricas na China, EUA, Reino Unido, Alemanha, Brasil, Romênia e Tailândia. Atualmente, aproximadamente 90 % do trabalho de fabrico do nosso grupo em termos de volume de produção é realizado no estrangeiro.

A rede mundial de vendas e serviços da Makita, assim como a qualidade estável e de alta produção assegurada nas suas fábricas em todo o mundo, são a e personificação da marca Makita.

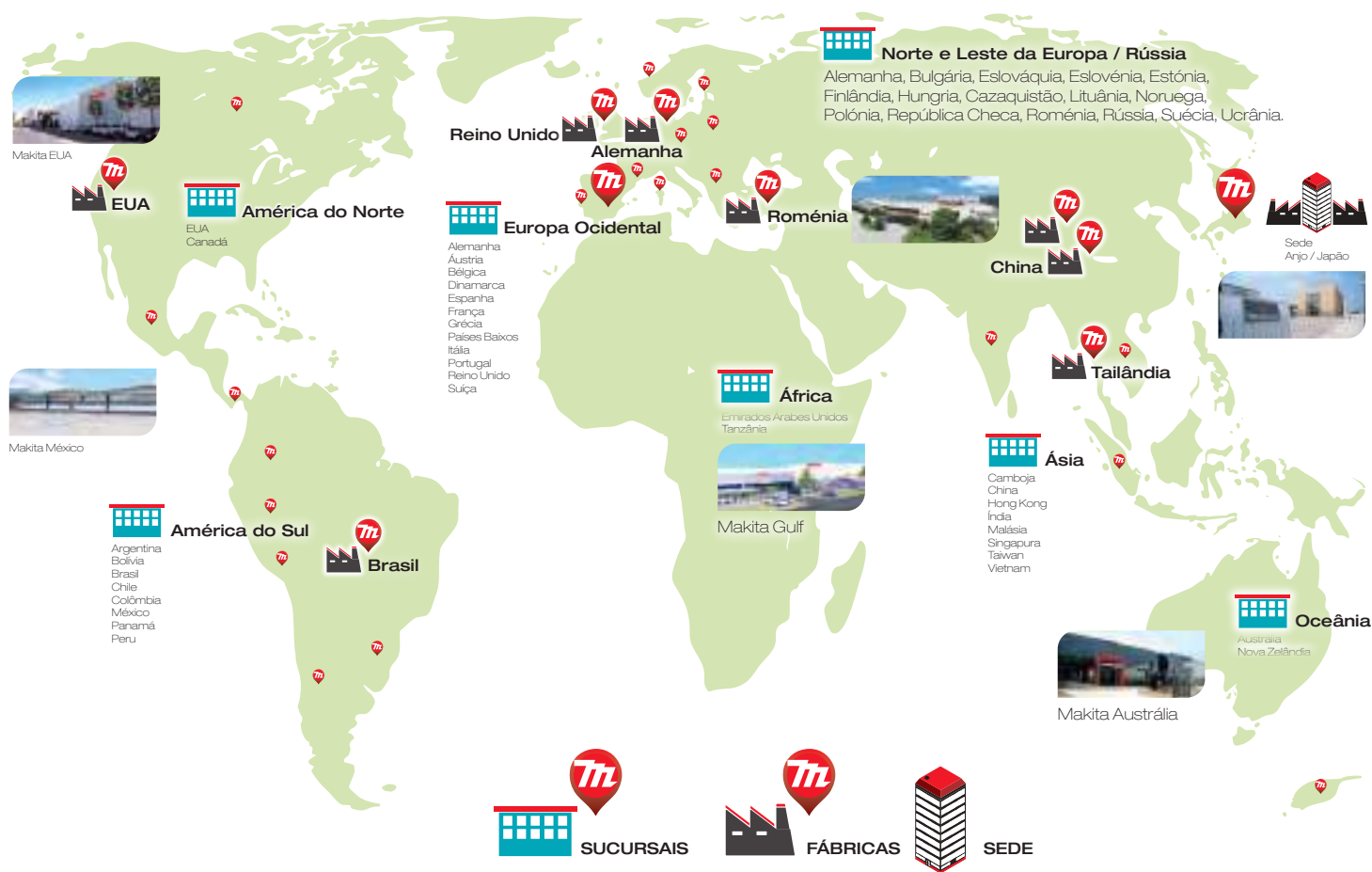

Japão
Makita Corporation



Japão
Fábrica Okazaki



E.U.A.
Makita Corporation of America



Reino Unido
Makita Manufacturing Europe Ltd.



Roménia
SC Makita EU SRL



Alemanha
Makita Engineering Germany



Brasil
Makita do Brazil Ferramentas Eléctricas Ltda.



China
Makita (China) Co., Ltd.



China
Makita (Kunshan) Co., Ltd.



Tailândia
Makita Manufacturing (Tailândia) Co., Ltd.

Por uma sociedade
descarbonizada



***Chegou a altura
de trocar a gasolina
pela bateria,
está nas nossas mãos cuidar
e respeitar o meio ambiente.***

Zero
emissões
Makita

LXT

36V

18V
LITHIUM-ION

XGT

XGT X2P
80 Years

40V max
LITHIUM-ION

CXT



1. Baterias e carregadores	21 - 42
2. Perfuração e demolição	43 - 74
3. Furar	75 - 106
4. Aparafusar	107 - 126
5. Limpar e aplinar	127 - 138
6. Diamante	139 - 152
7. Abrasivo - Rebarbadoras	153 - 170
8. Abrasivo - Lixas	171 - 186
9. Multifunções	187 - 200
10. Serras circulares, serras de esquadria e de incisão	201 - 224
11. Serras de sabre	225 - 238
12. Serras tico-tico	239 - 250
13. Fresagem	251 - 264
14. Decapar	265 - 268
15. Parafusos e pregos	269 - 274
16. Aspiração	275 - 292
17. Níveis	293 - 296
18. Roedoras, tesouras e puncionadoras	297 - 300
19. Jardim	301 - 324
20. Porta-ferramentas	325 - 375
21. Baterias NI-Cd/Ni-Mh	376
22. Caixas	377 - 383
23. Escovas	384 - 385
24. Kits de manutenção	386
25. Índice por código	387 - 396
Serviços Técnicos Autorizados	398 - 399

Índice

1. Baterias e carregadores

- Baterias e carregadores. *págs. 22 - 25*
- Fontes de alimentação externas. *págs. 26 - 27*
- Kits de fontes de alimentação *pág. 28*
- Iluminação. *págs. 35 - 42*



2. Perfuração e percussão

- Brocas SDS - PLUS. *págs. 44 - 51*



- Brocas SDS - MAX. *págs. 52 - 57*



- Demolição. *págs. 58 - 68*



- Porta-brocas e diversos. *pág. 69*



- Sistemas de aspiração. *págs. 70 - 73*



- Punhos. *pág. 74*



3. Furar

- Brocas:

- Unicut. *pág. 76*
- Tijolo. *pág. 77*
- Multimaterial. *pág. 78*
- Madeira. *págs. 79 - 81*
- Metal. *págs. 82 - 86*

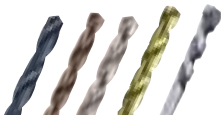

- Brocas para berbequim magnético HB500 e HB350. *pág. 87*



- Escareadores. *págs. 88 - 89*



- Estojos e caixas de brocas e acessórios. *págs. 90 - 97*



- Brocas de coroa. *págs. 98 - 101*



- Batedores. *pg. 101*



- Suportes para berbequins. *págs. 102 - 103*



- Porta-brocas. *págs. 104 - 105*



4. Aparafusar

- Pontas: *pág. 109 - 111*

Impact

PREMIER

págs. 112 - 113

IMPACT BLACK



- Porta-pontas. *pág. 115*



- Chaves de caixa. *págs. 116 - 117*



- Estojos de pontas. *págs. 118 - 120*



- Caixas de ferramentas manuais. *págs. 120 - 122*



- Bicos, caixas acessórios de aparafusadoras *págs. 123 - 126*



5. Limpar e aplainar

- Catrabuchas para berbequins e rebarbadoras. *págs. 128 -*



- Rolos para N9741. *págs. 134 - 135*



- Lâminas para plainas. *pág. 136*



- Guias. *pág. 137*



- Diversos. *págs. 138*



6. Diamante

- Discos de diamante:

quasar *págs. 141*

comet *págs. 142 - 144*

diamant *pág. 145*

Especial ferramentas a bateria *pág. 146*

X - LOCK *pág. 146*

Especial vidro e porcelana *pág. 147*

Especial salvamento - Polir betão *pg. 148*



- Brocas de diamante. *págs. 150 - 151*



- Brocas especiais para rebarbadora. *pág. 151*



- Suportes para DBM131, DBM130 e DBM230. *pág. 152*



- Acc. para PW5005CH. *pág. 152*



7. Abrasivo - Rebarbadoras

- Discos abrasivos:

Rebarbagem e corte. *págs. 155 - 156*

Abrasivo. *págs. 156 - 157*

Lâminas. *págs. 157 - 161*



- Mós ou rebolos *pág. 161*



- Punhos. *pág. 162*



- Coletores de pó. *pág. 162*



- Protetores de disco. *pág. 163*



- Vários:

Porcas. *pág. 164*

Filtros. *pág. 164*

Casquilhos para rebarbadoras retas. *pg. 166*



- Aces. para cortadores. *págs. 167*

- PW5000CH. *pág. 168*

- PC5001C. *págs. 168 - 170*

- DCC501. *pág. 170*



8. Abrasivo - Lixas

- Orbitais. *págs. 172 - 176*

Lixas.
Rolos.
Bases para lixadoras.



- Rotorbitais e de disco. *págs. 177 - 179*

Lixas.
Caixas de lixas.
Pratos.



- Lixadoras de cinta. *págs. 180 - 181*

Lixas.
Placas.



- Pratos, boinas de lâ. *págs. 182 - 183*



- Esponjas de velcro. *pág. 183*



- Vários *págs. 184 - 186*

Suportes.
Sacos.
Punhos...



Índice

9. Multifunções

- Starlock:
Corte e corte de imersão. *págs. 192 - 193*
Raspadores e lâminas de corte. *pág. 194*
Limpeza corte. *págs. 195 - 196*
Conjunto de lâminas. *pág. 196*
Lixas. *pág. 197*
- Starlock Max:
Corte e corte de imersão. *pág. 198*
Lâminas de corte de juntas e de diamante. *págs. 199*
Lâminas de corte de azulejos *pág. 200*
Limpeza e corte *pág. 200*



10. Serras

- Discos serras circulares. *págs. 206 - 211*

MAKFORCE

MFORCE

SPECIALIZED STANDARD

SPECIALIZED CONSTRUCCION

SPECIALIZED MAQUINAS DE BATERIA

SPECIALIZED REFORZADO

SPECIALIZED STANDARD

SPECIALIZED ALUMINIO

SPECIALIZED PANEL SANDWICH



- Discos para serras de incisão. *pág. 212*

SPECIALIZED INCISION

- Discos para serras de esquadria. *págs. 213 - 216*

MAKBLADE PLUS

SPECIALIZED S. MESA

SPECIALIZED ALUMINIO

SPECIALIZED LAMINADOS

- Discos para fresagem e corte. *pág. 217*
- Discos laminados cortadoras de metal. *págs. 218 - 219*
- Guias. *pág. 220 - 221*
- Mesas. *pág. 221 - 222*
- Vários: *págs. 222 - 224*
Batentes.
Suportes
Grampo.



11. Serras de sabre

- Metal. *págs. 227 - 228*
- Madeira. *págs. 229 - 230*
- S-Express. *pág. 230*
- Madeira + Metal. *págs. 231 - 232*
- Especiais. *pág. 233*
- JR100D e DJR183. *pág. 234*
- Folhas para 2107FK/2107FKX. *pág. 235*
- DPB181 e DSD180. *pág. 236*
- Aces. para LB1200. *pág. 237*
- Aces. para 2107FK. *pág. 238*



12. Serras tico-tico

- Super Express. *pág. 242*
- Madeira:
Corte básico. *pág. 242*
Corte rápido. *pág. 243*
Laminadas. *pág. 243*
Corte limpo. *pág. 244*
Madeiras duras. *pág. 244*
Com prego. *pág. 245*
- Metal. *pág. 245*
- Especiais. *pág. 246*
- Conjuntos de folhas a granel. *pág. 247*
- Inserção Makita. *págs. 248*
- Grampos, guias e adaptadores. *pág. 250*



13. Fresagem

- Madeira. *págs. 253 - 256*
- Furar alumínio. *pág. 257*
- Para 3706, DCO180 e DCO181. *pág. 257*
- PJ7000 e 3901. *pág. 258*
- 7104L. *pág. 258*
- Vários: *págs. 259 - 260*
Casquilhos.
Porcas.
Chaves.
- Guias: *págs. 261 - 262*
Gabarito.
Carril.
- RT0700C. *págs. 263 - 264*



14. Decapar

- Bicos. *págs. 267 - 268*



15. Parafusos e pregos

- Pente de parafusos para autoalimentadores. *pg. 270*
- Pregos: *págs. 272 - 273*
DPT351 e DPT353 - 0,6 mm.
AF505N e DBN500 - 1,2 mm.
AN250HC - Multimaterial.
GN420C - Multimaterial.
Carregador de pregos - GN420C
- Grampos. *pág. 273*
- Vários. *pág. 274*



16. Aspiração

- Acessórios para aspiradores. *págs. 278 - 280*
Tubos:
Flexíveis.
Curvos.
Retos.
Pés.
Bocais.
- Filtros. *pág. 282*
- Sacos. *pág. 283*
- Conexões para aspiradores. *págs. 284 - 291*
- DRC200. *pág. 292*



17. Laser

- Vários. *págs. 294 - 296*



18. Roedoras, tesouras e puncionadoras

- JS8000. *pág. 298*
- Matrizes. *pág. 298*
- Lâminas. *pág. 298*
- Acessórios para puncionadora DPP200. *págs. 299 - 300*



19. Jardim

- Barras, correntes, capas e aces. para motosserras e corta-sebes *págs. 304 - 306*
- Aces. para sopradores. *pág. 307*
- Aces. para UX001G/DUX60/DUX18. *pág. 309*
- Discos e cabeças para roçadoras. *pág. 310 - 313*
- Fios de nylon. *págs. 314 - 315*
- Óleos. *pág. 316*
- Arneses e proteção para roçadoras. *pág. 317*
- Aces. para perfurador DDG460. *pág. 318*
- Brocas para solo 3/4". *pág. 319*
- Aces. para DUC122 e UC120D. *pág. 319*
- Aces. para tesouras de poda. *pág. 320*
- Aces. para corta-sebes e corta-relvas. *pág. 321*
- Lavadoras de alta pressão. *págs. 322 - 324*
Lanças e pistolas.
Mangueiras.
Escovas.
Adaptadores.
- Acessórios para DCU180 *pág. 324*



Makita. Recomendações de segurança.**Importante**

- Ao utilizar ferramentas elétricas, as recomendações básicas de segurança devem ser sempre seguidas para reduzir o risco de incêndio, choque elétrico e ferimentos pessoais, tais como as indicadas a seguir.

Mantenha a área de trabalho limpa

As áreas e mesas de trabalho desorganizadas podem provocar lesões.

Tenha em conta o ambiente de trabalho

Não utilize ferramentas elétricas em ambientes húmidos ou molhados. Mantenha a Área de Trabalho iluminada. Não exponha ferramentas elétricas à chuva. Não utilize ferramentas elétricas na presença de líquidos ou gases inflamáveis.

Mantenha as crianças afastadas

Todos os visitantes devem manter-se afastados da área de trabalho. Não permita que os visitantes toquem na ferramenta ou nos cabos de extensão.

Guarde as ferramentas num local apropriado

Quando não estiverem a ser utilizadas, as ferramentas devem ser guardadas num local seco e a uma altura que as mantenha fora do alcance das crianças.

Não force a ferramenta

Ela realizará melhor seu trabalho e de forma mais segura ao ritmo para o qual foi projetada.

Use a ferramenta apropriada

Não force ferramentas pequenas ou acessórios para realizar o trabalho de uma ferramenta maior. Não utilize ferramentas para fins para os quais não foram concebidas.

Vista-se de forma adequada

Não use roupa solta ou joias. Podem ser presas entre as partes móveis. O uso de luvas de borracha e calçado antiderrapante é recomendado para trabalhos ao ar livre.

Faça o uso adequado do cabo

Nunca mova a ferramenta pelo cabo nem a puxe para desconectá-la da tomada. Mantenha o cabo afastado do calor, óleo e ângulos afiados.

Trabalhe em segurança

Use abraçadeiras para sustentar o trabalho. É mais seguro do que usar a mão para sustentá-lo e permite-lhe utilizar a ferramenta com ambas as mãos.

Não ultrapasse os limites

Mantenha-se sempre seguro e em equilíbrio.

Mantenha as ferramentas com cuidado

Mantenha as ferramentas de corte afiadas e limpas para uma utilização mais segura e eficaz. Siga as instruções sobre lubrificação e troca de acessórios. Inspeccione periodicamente o cabo da ferramenta e, se estiver danificado, repare-o num centro de serviço autorizado. Inspeccione periodicamente os cabos de extensão e substitua-os se estiverem danificados. Mantenha os cabos secos, limpos e livres de gordura e óleo.

Desligue as ferramentas

Quando não estiver a ser usadas, antes de as usar e ao trocar acessórios, como lâminas.

Remover chaves de ajuste e inglesas

Tenha o hábito de verificar se retirou as chaves de ajuste ou inglesas que tenha usado para ajustar a máquina antes de a ligar.

Evite o arranque acidental

Não transporte uma ferramenta ligada com um dedo no interruptor. Ao ligar, certifique-se de que o interruptor está na posição OFF.

Use extensores no exterior

Ao utilizar a ferramenta ao ar livre, utilize apenas cabos de extensão destinadas a este uso.

Esteja atento

Observe o que está a fazer. Utilize o bom senso. Não use a ferramenta quando estiver cansado.

Verifique se há peças danificadas

Antes de continuar a utilizar a ferramenta, as proteções ou qualquer peça que se encontre danificada devem ser verificadas para determinar se funcionam corretamente e cumprem a sua finalidade. Verificar o alinhamento e o deslocamento dos elementos móveis, rufuras, montagem e qualquer outra condição que possa prejudicar o seu funcionamento. Os protetores ou qualquer outra peça danificada devem ser substituídos ou reparados por um centro de serviço autorizado, salvo indicação em contrário no seu manual de instruções. Substitua os seus interruptores num centro de serviço autorizado. Não utilize a ferramenta se o interruptor não a ligar ou desligar.

Proteja-se contra choques elétricos

Evite o contacto direto do corpo com superfícies com ligação à terra (por exemplo, tubos, radiadores, frigoríficos, etc.)

Peças sobressalentes

Utilize apenas peças sobressalentes idênticas à peça original.

Aviso de tensão

Antes de ligar a ferramenta a uma fonte de alimentação. Certifique-se de que a tensão fornecida é idêntica à tensão indicada na placa de identificação da ferramenta. Uma tensão superior à especificada na ferramenta pode causar DANOS SÉRIOS ao operador, bem como à própria ferramenta. Em caso de dúvida, NÃO LIGUE COM A FERRAMENTA. A utilização de uma fonte de alimentação com uma tensão inferior à indicada é prejudicial para o motor.

NOTA

A Makita reserva-se o direito de alterar as especificações das ferramentas, equipamento básico e acessórios sem aviso prévio. O equipamento básico e as especificações das peças podem variar de país para país. A cor padrão de fábrica é Verde Industrial Makita (azul). Por favor, indique a tensão necessária em cada encomenda. Estas ofertas estão sujeitas à disponibilidade em cada país.

A cor dos produtos pode variar ligeiramente em relação à cor mostrada neste catálogo.

É sempre recomendável completar as informações contidas neste catálogo por telefone ou correio eletrónico.

Makita Limited**Garantia**

Todas as ferramentas Makita passam por um rigoroso processo de inspeção e teste antes de sair da fábrica. Eles são garantidos contra defeitos de fabrico e/ou materiais. Se ocorrer algum problema, por favor, envie a ferramenta COMPLETA à Makita ou entregue-a no seu ponto de venda habitual. Se após a inspeção se demonstrar que o problema se deve a uma falha de fabrico/material, todas as reparações necessárias serão efetuadas sem custos. A garantia não cobre reparações efetuadas por terceiros; reparações devidas ao desgaste normal; uso indevido da ferramenta ou queda acidental; utilização manifestamente incorreta - causada por sobrecarga da ferramenta para além da sua capacidade, utilização da ferramenta após uma avaria parcial ou utilização com acessórios inadequados.

Riscos e desvantagens da utilização de contrafações

ATENÇÃO: Relatórios Makita

- Infelizmente o crescimento das compras online criou espaço para oportunistas que procuram tirar partido do consumidor a todo custo. Produtos que são imitações são cada vez mais comuns na Internet, particularmente através de leilões em que o vendedor é anónimo e a sua utilização pode levar a sérios problemas. A seguir explicamos as principais características para diferenciar as nossas ferramentas e acessórios originais:



Logótipo Makita

O logótipo Makita deve ser moldado diretamente na caixa da ferramenta e com o símbolo de marca registada ©.



Etiqueta

As etiquetas Makita devem corresponder ao modelo e às especificações da ferramenta que ostenta a etiqueta. Etiquetas falsas muitas vezes têm o nome do modelo em minúscula.



Acabamento

O acabamento das ferramentas Makita é metal polido. As contrafações são frequentemente lacadas para dar a aparência deste brilho.



Componentes

Os componentes das ferramentas Makita são sempre de qualidade superior, mais duráveis e de melhor material.



Embalagem

As caixas de papelão ou caixas em que as ferramentas Makita são embaladas são de maior qualidade e protegem melhor o produto, já que se adaptam melhor ao modelo que contêm.



Componentes

Ao registar a ferramenta em www.makita.pt, a Makita concede até três anos de garantia em todos os seus modelos. Dentro da caixa encontrará a prova desta garantia, que as falsificações não terão.

ATENÇÃO: UTILIZE BATERIAS ORIGINAIS

Segurança

Em muitos casos, os produtos falsificados não foram fabricados e testados de acordo com os padrões de qualidade e segurança exigidos por lei. Estes riscos incluem o perigo de danos ao produto em resultado de vazamento ou superaquecimento da bateria a tal ponto que a bateria pode incendiar-se.

Qualidade

Não é possível garantir o correto desempenho de uma bateria falsificada. Existem baterias não genuínas no mercado que afirmam ter o mesmo Ah que as baterias Makita, mas que são significativamente menos potentes. Uma bateria Makita original também incluirá um chip incorporado que otimiza a vida útil da bateria.

Como identificar baterias falsas

Ao comprar produtos é importante reconhecer aqueles sinais de aviso que indicam que o produto é original. Recomendamos comprar em revendedores autorizados Makita em Espanha e ter cuidado com os vendedores com preços involuntariamente baixos.



Graças aos aspiradores Makita, terá um espaço limpo e seguro.

O filtro HEPA remove mais de 99,75 % das partículas no ar.

HEPA
filter



Novas Baterias dorsais

18 V x 2 LXT/36 V/40 V máx. 33,5 Ah

Até seis vezes mais tempo de funcionamento com ferramentas de 18 V x 2 LXT (6,0 Ah)



PDC1200A01*
PDC1200A02

LXT
LITHIUM ION TECHNOLOGY

18V x 2 → 36V

XGT

40V^{max}



* Inclui adaptador 18 V x 2 LXT



- O arnês de libertação rápida permite o uso desta bateria como uma fonte de alimentação fixa.
- Interruptor de alimentação principal com função de desligamento automático.



Ajuste da altura da bateria para maior conforto do utilizador.



Indicador de carga da bateria de 4 LED.

PDC1200A01*

PDC1200A02

1854,00 €

1741,00 €

- O modelo PDC1200 é uma bateria com uma capacidade de 1200 Wh, 33,5 Ah e uma tensão entre 36 V e 40 V máx. (aproximadamente).
- Até 2,8 vezes mais tempo de duração do que a nossa mochila porta-baterias PDC01 carregada com quatro baterias de 18 V LXT 6,0 Ah (BL1860B).
- Compatível com três plataformas: 18 V x 2 LXT (adaptador opcional), ligação de alimentação direta de 36 V e com 40 V máx. XGT (adaptador opcional).
- Bateria não compatível com aspiradores, tesouras de poda, motosserras exceto modelo DUC355 e modelos 40 V max. XGT, serra circular DHS710 e martelo leve série DHR280
- Graças à estrutura do arnês, a bateria pode ser mantida verticalmente no chão.

XGT
40V **Li-ion**
max



o **XGT** é um **NOVO** sistema com as suas próprias ferramentas, baterias e carregadores. Uma combinação de ferramentas inovadoras. O design e as baterias mais potentes oferecem uma verdadeira solução para utilizadores industriais de elevada exigência



BL4050

Bateria de íões de lítio de 5,0 Ah.
 Tempo de carregamento aproximado:
 50 min com carregador rápido.



BL4040

Bateria de íões de lítio de 4,0 Ah.
 Tempo de carregamento aproximado:
 45 min com carregador rápido.



BL4025

Bateria de íões de lítio de 2,5 Ah.
 Tempo de carregamento aproximado:
 28 min com carregador rápido.

BATERIA **DE ALTA POTÊNCIA**



- O XGT é uma verdadeira solução para aplicações industriais de alta procura e é uma combinação do design inovador da ferramenta e da alta potência oferecida pelas baterias.

TECNOLOGIA **INTELIGENTE**



- A gama de ferramentas e baterias XGT tem um programa incorporado, que proporciona uma comunicação digital entre a bateria e a ferramenta. Permite não só a comunicação da bateria com a ferramenta, como também que a ferramenta comunique com a bateria.

DURABILIDADE



- O XGT é duradouro e foi concebido para trabalhar! As baterias e as ferramentas XGT também foram concebidas para suportar condições ambientais difíceis.

PRONTO PARA **O FUTURO**



- O XGT e o LXT coexistem para proporcionar aos utilizadores uma gama inigualável de ferramentas a bateria nas aplicações comerciais profissionais e aplicações de elevada procura energética.



A MAKITA OFERECE A VISÃO DO FUTURO DAS FERRAMENTAS SEM FIO

A inovação sem fios é muito mais do que baterias melhores. Trata-se de criar uma tecnologia de baterias e engenharia de motores que trabalham em conjunto para um excelente desempenho.



BL4020

Bateria de íões de lítio de 2,0 Ah. Tempo de carregamento aproximado: 22 min com carregador rápido.



DC40RA

Carregador rápido para baterias de 40 V máx. XGT estilo calha com ventiladores.



ADP10

Adaptador, permite que o carregador DC40RA também carregue baterias de 18 V LXT.



Características

A gama de ferramentas e baterias XGT dispõe de um chip incorporado, que proporciona comunicação digital entre a bateria e a ferramenta e o carregador. Tecnologia da bateria e engenharia do motor para que trabalhem em conjunto de forma otimizada.

As baterias têm calhas rígidas que as mantêm firmemente no lugar quando são utilizados os novos produtos de alta potência.

Paredes de proteção. Protegem os terminais da água e do pó.

Indicador de carga com quatro LED que se encontra na parte dianteira da bateria para que seja fácil saber quando deve ser recarregada.

O design resistente de 40 V máx. carrega as baterias em apenas 28 minutos (BL4025).

Um acessório adaptador de carregamento que permite carregar produtos LXT e XGT (mais de 320 no total).

Sistema de carregamento ótimo

Carregador rápido

- Se a temperatura da bateria for elevada, é necessário que esta arrefeça antes de se iniciar o carregamento.
- O ventilador incorporado faz circular o ar através da bateria antes de começar a carregar e durante o processo de carregamento para arrefecê-la. Desta forma, o tempo de carregamento é menor.

- O carregador rápido da Makita comunica com o chip incorporado na bateria durante todo o processo de carregamento para otimizar a vida útil da bateria através do monitoramento ativo da corrente, voltagem e temperatura.

- Sistema de carregamento ótimo.
- Sistema de carregamento geral.



- Carregamento rápido.



- Tempo de espera para carregar.



Sistema de carregamento ótimo

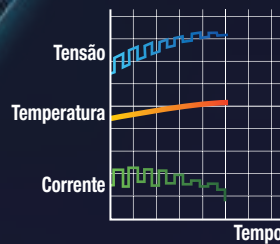

Sistema de carregamento geral

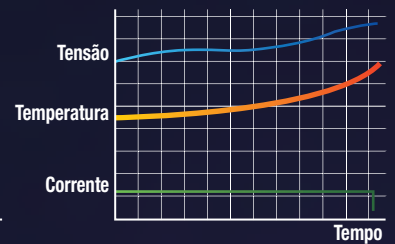

40 % mais leve



Makita
18 V e íões de lítio de 5,0 Ah
14,4 V e íões de lítio de 5,0 Ah

Makita
18 V/14,4 V
Ni-Mh 2,8 Ah



*Terminais multicontacto
Reduzem a resistência elétrica e aumentam a estabilidade da ligação. Resistentes contra as vibrações e, em última instância, garantem um fornecimento de corrente estável à ferramenta.*



Proteção da bateria

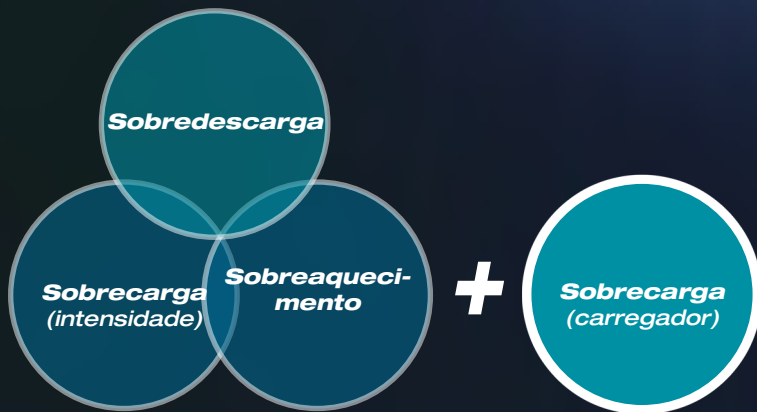

- Esta função é a tecnologia de comunicação que permite que a ferramenta e a bateria monitorizem as condições e troquem dados em tempo real. Desta forma, a bateria é protegida contra a sobrecarga e sobreaquecimento.

*Carregamento em qualquer momento
Sem efeito de memória.
Não é necessário descarregar.*



*Muito resistente.
Invólucro rígido.*



*Longa duração.
Baixa autodescarga.*



Motor sem escovas

- Motor sem escovas Makita:
- Elimina as escovas de carbono, permitindo que o motor funcione mais frio e eficientemente para uma vida útil mais longa.
- Este motor é controlado eletronicamente e, por isso, utiliza a energia para fazer coincidir o binário e as rpm com as mudanças de aplicação.

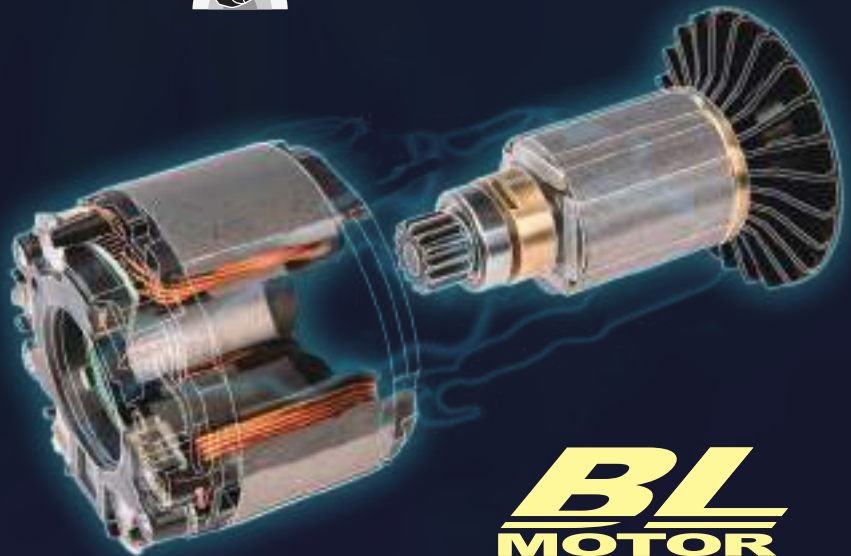

**BL
MOTOR**

Baterias e carregadores com Sistema de carregamento ótimo.

DC18RC

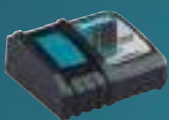

DC18RD



Carregador rápido com duas entradas.

DC18RE



Carregador rápido com duas entradas CXT e LXT.

DC18SF



Multicarregador com quatro entradas.
* Exceto BL1420A.

DC18SD



DC18SE



Automóvel.

Acessórios ideais para ferramentas a bateria



Fornecem o melhor desempenho nas ferramentas a bateria!

Mais velocidade, mais trabalho com uma única carga de bateria completa e uma boa sensação de uso. Os acessórios recomendados para ferramentas sem fio podem ser encontrados sob os símbolos acima.

Experimente e veja a nossa vasta gama de acessórios Makita!



Impact
PREMIER



Maior precisão de ajuste.

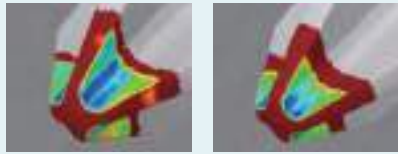

Com um parafuso por perto Com um parafuso à distância



Impact
PREMIER

Padrão

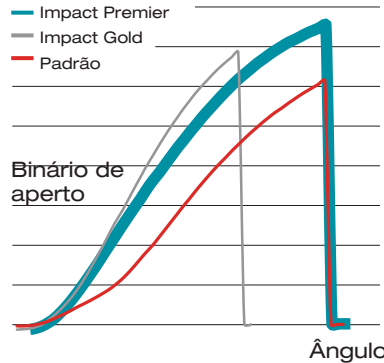

Dupla torção para maior durabilidade.



Serra de sabre de dente japonês



Dentes japoneses de 0,6 mm de espessura para um corte mais limpo do material.

Serra de dente japonês:

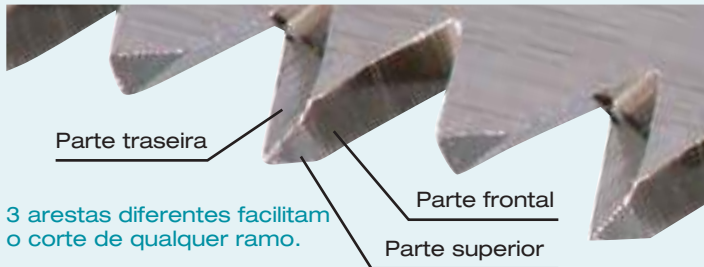

Qualidade superior



Acabamento com dente japonês



Acabamento com dente normal



Fio de nylon de quatro lâminas

Quatro folhas

O formato de quatro lâminas reduz o ruído e aumenta o tempo de trabalho.



Características

A forma do fio de quatro lâminas cria um pequeno vértice que reduz o ruído de corte e prolonga o tempo de trabalho devido à menor resistência.

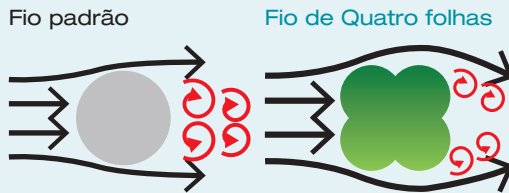

Número de cortes por carga

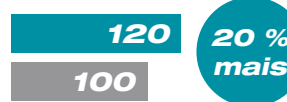

Ruído



Corrente para motosserra série 80



Características

Forma de corte ideal para um corte suave

Passo curto da corrente para reduzir a vibração

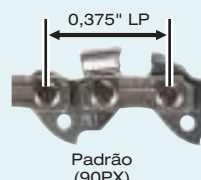
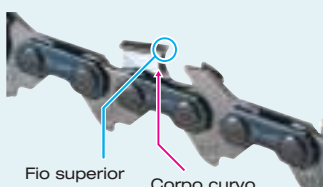

Vibração



15 % menos

Número de cortes por carga



20 % mais



Serras circulares TCT EFFICUT



EFFICUT



Características

Eficiente
Ângulo superior agudo



Eficiente
Corpo curvo



Eficiente
Base retificada



Número de cortes por carga

100

**140 %
mais**

240

Padrão
165 mm x 48 T

EFFICUT
165 mm x 56 T

EFFICUT
Compósito

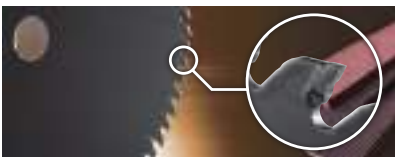

Características

Eficiente
Base retificada



Eficiente
Corpo curvo



Número de cortes por carga

100

**30 %
mais**

130

Padrão
180 mm x 40 T

EFFICUT
185 mm x 40 T

EFFICUT
Metal

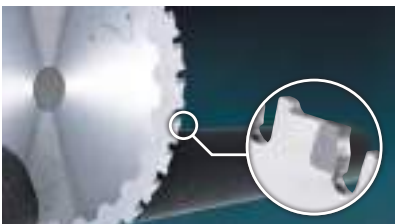

Características

Reduz as rebarbas
Maior robustez



Corte mais suave
Reduz o ruído e a vibração



Aumento da produtividade
Topo de corte reto

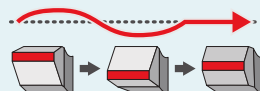

Número de cortes por carga

100

**60 %
mais**

160

Padrão
150 mm x 32 T

EFFICUT
150 mm x 33 T

EFFICUT
Alumínio



Características

Reduz as rebarbas
Maior robustez



Corte mais suave
Reduz o ruído e a vibração



Aumento da produtividade
Topo em corte reto

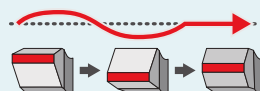

Otimização do trabalho
Menor resistência de corte



Número de cortes por carga

100

**40 %
mais**

140

Padrão
260 mm x 80 T

EFFICUT
260 mm x 81 T



Disco de diamante segmentado
Ideal para cortadores a bateria

Os diamantes são distribuídos na estrutura do segmento, alcançando assim uma maior eficiência de trabalho.
Ranhurinhas mais estreitas, maior capacidade de corte.

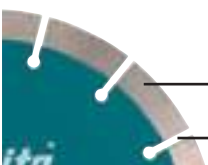

Número de cortes por carga

100

**65 %
mais**

165

Padrão
Para bateria

Disco abrasivo para metal
Ideal para cortadores a bateria

Mistura ideal de grão abrasivo e aglutinante para cortadores a bateria.



Número de cortes por carga

100

**10 %
mais**

110

Padrão
Para bateria





0,8mm

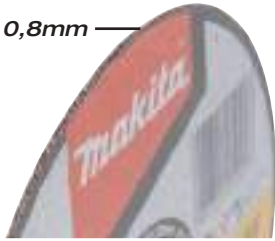

Disco de corte fino

0,8 mm de espessura para um corte mais rápido

Espessura reduzida

Corte rápido/menos resistência ao corte/melhor acabamento/menos produção de pó



Padrão
1 mm de espessura



Para bateria
0,8 mm de espessura

Número de cortes por carga

100

120

20 %
mais

1,4 mm

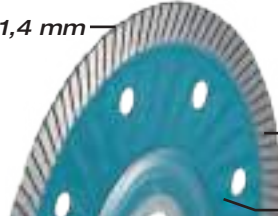

Disco de diamante seg.

Corte suave e preciso

Espessura reduzida sem perda de força

Com 1,4 mm, consegue um corte suave e preciso.

Com um interior corrugado para aumentar a tensão e reduzir as vibrações durante o corte.

Para azulejos



Padrão
2,3 mm de espessura



Para bateria
1,4 mm de espessura

Número de cortes por carga

100

160

60 %
mais

1,6 mm

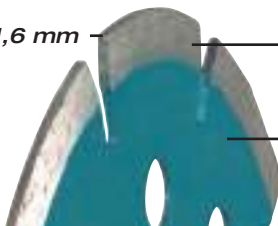

Especialmente concebido para trabalhos de corte
Com 1,6 mm, corta de forma suave e precisa em betão ou pedra.

O corpo do disco é mais leve do que os modelos anteriores, facilitando o corte e aumentando o tempo de utilização com uma bateria totalmente carregada.

Para betão/pedra



Padrão
2,2 mm de espessura



Para bateria
1,6 mm de espessura

Número de cortes por carga

100

150

50 %
mais

XLOCK

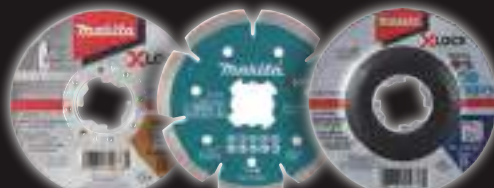

Disco de corte fino

Disco de diamante

Disco de rebarbagem



Troca rápida

Aumenta a velocidade de troca de acessórios sem peças intercambiáveis.



Sem ferramentas

O disco pode ser trocado sem a necessidade de ferramentas externas.



2,5 mm



Disco abrasivo para metal

Especialmente concebido para cortadoras

Espessura reduzida e aglutinante ideal

Disco de 2,5 mm de espessura para um corte suave e rápido. Com um ótimo aglutinante para aumentar a vida útil do disco.



Padrão
3 mm de espessura



Para bateria
2,5 mm de espessura

Número de cortes por carga

100

130

30 %
mais





GAMA DE EXTERIORES
OUTDOORS

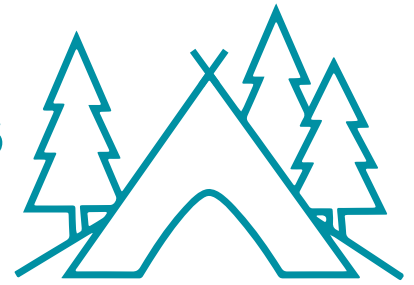

MELHORE A SUA EXPERIÊNCIA



XGT **40V** **Li-ion**
max

LXT
Litio-ion **EXTREMA TECNOLOGIA**

CXT

Bateria



Baterias XGT, LXT, carregadores e compatibilidade de carregamento



CARREGADOR DUPLO RÁPIDO

DC40RB
191N09-8



258 €

CARREGADOR RÁPIDO

DC40RA
191E07-8



160 €

DC40RC
191M90-3



93 €



5,0 Ah		314 € BL4050F 191L47-8
4,0 Ah		268 € BL4040 191B26-6
2,5 Ah		211 € BL4025 191B36-3
2,0 Ah		191 € BL4020 191L29-0

Tempo de carregamento		
50 min	50 min	85 min
45 min	45 min	67 min
28 min	28 min	38 min
22 min	22 min	30 min

18 V iões de lítio



DC40RA
191E07-8

160 €

ADP10
191C10-7

66 €



		Tempo de carregamento
6,0 Ah		232 € BL1860B 197422-4
5,0 Ah		201 € BL1850B 197280-8
4,0 Ah		170 € BL1840B 197265-4
3,0 Ah		144 € BL1830B 197599-5
2,0 Ah		113 € BL1820B 197254-9
1,5 Ah		93 € BL1815N 196235-0

* Apenas baterias cuja primeira letra de identificação é "I" ou "J".

Baterias LXT, carregadores e compatibilidade de carregamento

 <p>DC18RC 195584-2</p> <p>DC18RD 196933-6 2 entradas</p> <p>DC18RE 198720-9 2 entradas CXT/LXT</p> <p>CARREGADOR RÁPIDO</p> <p>112 €</p>	 <p>DC18SF 196426-3 Multicarregador com quatro entradas * Exceto BL1430A.</p> <p>294 €</p>	 <p>DC18SH 199687-4 Carregador 2 entradas</p> <p>DC18SD 194533-6</p> <p>DC18SE 194622-7 Automóvel</p> <p>113 € 76 € 113 €</p>
--	---	---

18 V iões de lítio

		Tempo de carregamento			
		Entre 1 e 2 baterias		Entre 2 e 4 baterias	
6,0 Ah	 232 € BL1860B 197422-4	55 min	130 min	260 min	130 min
5,0 Ah	 201 € BL1850B 197280-8	45 min	110 min	220 min	110 min
4,0 Ah	 170 € BL1840B 197265-4	36 min	90 min	180 min	90 min
3,0 Ah	 144 € BL1830B 197599-5	22 min	60 min	120 min	60 min
2,0 Ah	 113 € BL1820B 197254-9	24 min	45 min	90 min	45 min
1,5 Ah	 93 € BL1815N 196235-0	15 min	30 min	60 min	30 min

14,4 V iões de lítio

		Tempo de carregamento			
		Entre 1 e 2 baterias		Entre 2 e 4 baterias	
4,0 Ah	 165 € BL1440 196388-5	36 min	90 min	90 min	180 min
3,0 Ah	 139 € BL1430B 197615-3	22 min	60 min	60 min	120 min
1,5 Ah	 110 € BL1415N 196875-4	15 min	30 min	30 min	60 min

Baterias de íões de lítio, CXT, carregadores e compatibilidade de carregamento

18 V
íões de lítio

1,5 Ah



72 €

BL1815G
198186-3

Para os modelos:
DF457D, HP457D, JV183D,
TD127D e DMR106.

14,4 V
íões de lítio

1,5 Ah



62 €

BL1415G
198192-8

Para os modelos:
DF347D, HP347D,
JV143D e DMR106.



53 €

DC18WA
195423-6

70 min

CXT
12 V



112 €

DC10SB
197363-4



77 €

DC10WD
197343-0

4,0 Ah



91 €

BL1041B 197406-2

60 min

130 min

2,0 Ah



70 €

BL1021B 197396-9

30 min

70 min

10,8 V
íões de lítio



DC10WA
194588-1

47 €

7,2 V
íões de lítio

1,3 Ah



57 €

BL1013 196066-7

50 min

1,5 Ah



52 €

BL7015 198000-3

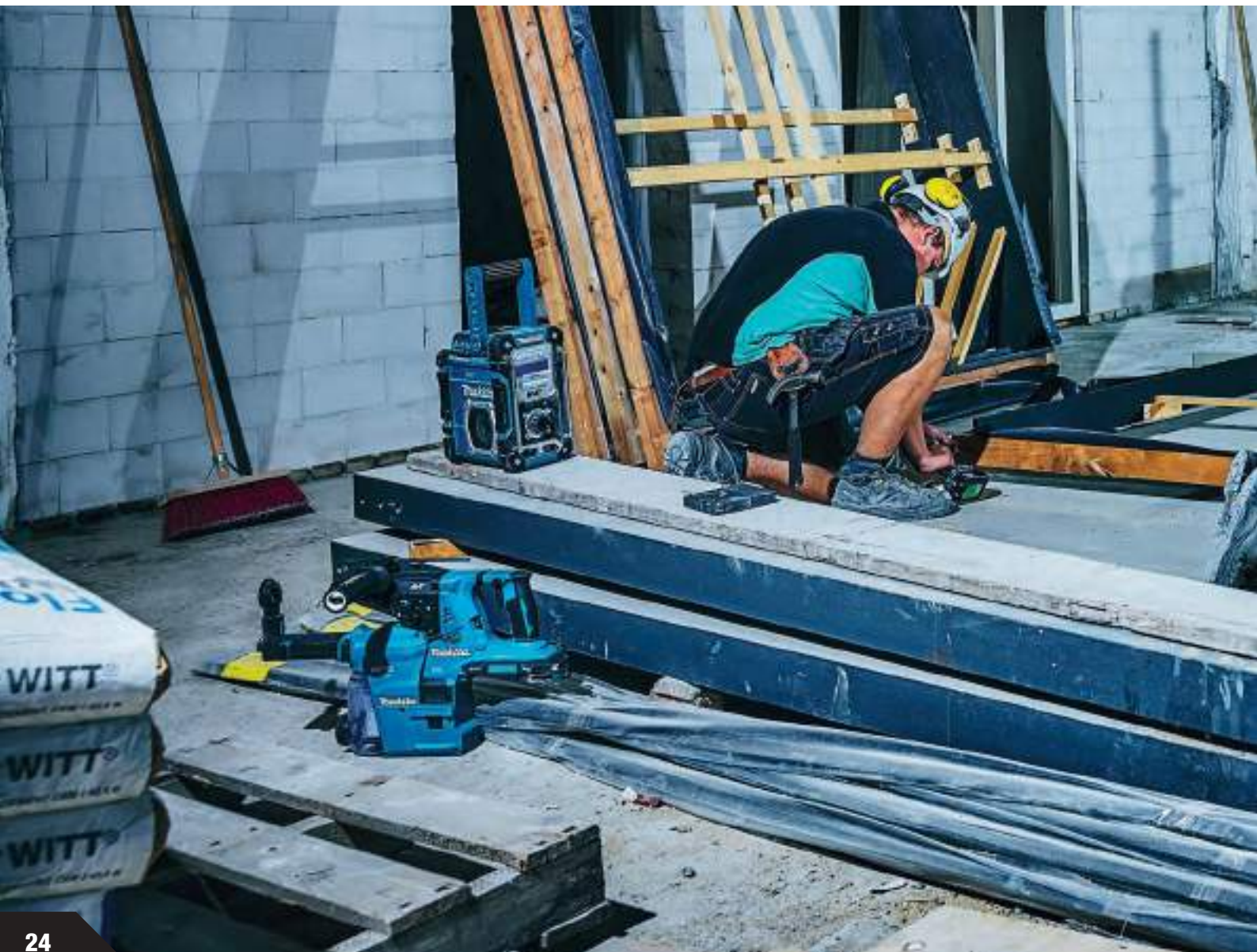

Adaptadores de corrente



Adaptador para
DMR100/DMR102
DMR107
SE00000078 **16,5 €**



Adaptador para
DCF201
TEB0000006 **32 €**



Adaptador para
DMR106/DMR108
DMR112
SE00000101 **24 €**



Adaptador para
DMR200
DMR201
SE00000501 **14,4 €**



Adaptador para
ADP07
DF001D
198363-7 **12,6 €**



Adaptador para
DMR115
SE00000679 **31 €**



Adaptador 12-24 V
para DCW180
WL00000002 **9,25 €**



Adaptador 220 V
para DCW180
WL00000058 **77 €**



Carregador DC4001
para PDC1200
191L00-4 **196 €**



FONTES DE ALIMENTAÇÃO EXTERNAS

PDC1200

Nova bateria de mochila 18 V x 2 LXT/40 V máx.

33,5 Ah

Tem uma capacidade de 1200 Wh, 33,5 Ah e uma tensão entre 36 V e 40 V máx. (aproximadamente).

Até 2,8 vezes mais tempo de duração do que a nossa mochila porta-baterias PDC01 carregada com quatro baterias de 18 V LXT 6,0 Ah.

Compatível com: 18 V x 2 LXT (adaptador opcional), ligação de alimentação direta de 36 V e com 40 V máx. XGT (adaptador opcional).

Até seis vezes mais tempo de funcionamento com ferramentas de 18 V x 2 LXT e 6,0 Ah.



IPX4



Carregador: DC4001

Tempo de carregamento: 6 horas

Funções e vantagens

- Com bateria integrada de 40 V máx.
- Alta capacidade: 1200 Wh. (aprox. seis vezes mais tempo de funcionamento do que com ferramentas de 18 V x 2 LXT com BL1860Bx2)



Altura ajustável

A posição do arnês pode ser ajustada para maior conforto.



Arnês de remoção rápida

Pode ser encaixado e retirado da unidade de bateria com um só movimento.



Refletores

Para maior visibilidade do utilizador no escuro.

PDC1200A01 **1854 €*
PDC1200A02 **1741 €****

* Inclui adaptador 18 V x 2

Mochila porta-baterias

PDC01

IPX4



**191C50-5
inclui adaptadores
18 V e 18 V x 2
4 baterias 5,0 Ah
Multicarregador com
duas entradas**
1777 €

**191A59-5
inclui adaptadores
18 V e 18 V x 2**
1854 €

**191A64-2
inclui adaptador
18 V x 2**
680 €

Funções e vantagens

- Possibilidade de ligar até quatro baterias LXT de 18 V
- Alta capacidade: 432 Wh (com quatro baterias BL1860B)



Altura ajustável

A posição do arnês pode ser ajustada para maior conforto.



Arnês de mochila

Pode ser separado do compartimento das baterias, transformando-se assim numa fonte de alimentação fixa.



Indicador de carregamento

Indica o estado de carregamento de cada bateria com luzes verdes. Com função de desligamento automático.



Tipos de ligação e adaptadores

Ligação direta



40 V máx.



Adaptador 155 €

191N62-4



18 V x 2



Adaptador 180 €

191J51-5



18 V (apenas PDC01)



Adaptador 124 €

191J50-7



Especificações

	PDC1200	PDC01
Capacidade	33,5 Ah	*
Armazenamento	1206 Wh	*
Número de células	100	-
Tempo de carregamento (horas)	6	-
Dimensões (L x C x A)	sem arnês: 369 x 261 x 139 mm com arnês: 428 x 261 x 164 mm	sem arnês: 400 x 195 x 132 mm com arnês: 400 x 270 x 149 mm
Peso líquido	sem arnês: 8,8 kg	sem baterias: 2,8 kg

* Depende das baterias selecionadas.





Kits de fonte de alimentação

- Kits de bateria: 2 baterias de 5,0 Ah, multicarregador rápido e mala Makpac3.



191U13-9 5,0 Ah



2 x BL4050F
1 x DC40RB
1 x 821551-8

803 €

- Kits de baterias: 2 baterias de 4,0 Ah, multicarregador rápido e mala Makpac3.



191U00-8 4,0 Ah



2 x BL4040
1 x DC40RB
1 x 821551-8

711 €

- Kits de baterias: Baterias de 4,0 Ah e carregador rápido.



191J65-4 4,0 Ah



1 x BL4040
1 x DC40RA

386 €

- Kits de baterias: 2 baterias de 4,0 Ah, carregador rápido e mala Makpac1.



191J97-1 4,0 Ah



2 x BL4040
1 x DC40RA
1 x 821549-5

695 €

- Kits de baterias: 2 baterias de 2,5 Ah, carregador rápido e mala Makpac1.



191J81-6 2,5 Ah



2 x BL4025
1 x DC40RA
1 x 821549-5

505 €

- Kits de baterias: Baterias de 2,5 Ah e carregador rápido.



191J39-5 2,5 Ah



2 x BL4025
1 x DC40RA

479 €

- Kits de baterias: 2 x baterias de 6,0 Ah, carregador rápido e mala Makpac1.



198116-4 6,0 Ah



2 x BL1860B
1 x DC18RC
1 x 821549-5

618 €

- Kits de baterias: 2 baterias de 6,0 Ah, multicarregador rápido e mala Makpac3.



198077-8 6,0 Ah



2 x BL1860B
1 x DC18RD
1 x 821551-8

670 €

- Kits de baterias: 2 baterias de 5,0 Ah, multicarregador rápido e mala Makpac3.



197626-8 5,0 Ah



4 x BL1850B
1 x DC18RD
1 x 821551-8

824 €

Baterias e carregadores

Descrição	Código	EAN	P.V.P (€)
Carregador rápido XGT - DC40RA	191E07-8	0088381556354	160,00
Carregador XGT - DC40RC	191M90-3	0088381579261	93,00
Multicarregador 2 entradas XGT - DC40RB	191N09-8	0088381579117	258,00
Carregador 7,2 V-18 V LXT - DC18RC	195584-2	0088381373562	112,00
Multicarregador rápido 2 entradas LXT - DC18RD	196933-6	0088381444033	206,00
Multicarregador com 2 entradas LXT - DC18SH	199687-4	0088381542470	113,00
Multicarregador com 4 entradas LXT - DC18SF	196426-3	0088381432979	294,00
Carregador 12 V CXT / 18 V LXT - DC18RE	198720-9	0088381487924	175,00
Carregador 18 V LXT - DC18SD	194533-6	0088381345811	76,00
Carregador de carro LXT - DC18SE	194622-7	0088381349673	113,00
Mochila porta-baterias - PDC01	191A59-5	0088381548588	953,00
Mochila porta-baterias - PDC01 com adaptador (x2)	191A64-2	0088381548632	680,00
Mochila portátil com baterias	191C50-5	0088381553544	1777,00
Bateria de mochila LXT/40 V máx. 33,5 Ah + Adaptador - PDC1200A01	PDC1200A01	0088381728621	1854,00
Bateria de mochila LXT/40 V máx. 33,5 Ah - PDC1200A02	PDC1200A02	0088381728645	1741,00
Kit de fonte de alimentação 6,0 Ah BL1860B x2 + DC18RC + MakPac 3	198116-4	0088381474146	618,00
Kit de fonte de alimentação 6,0 Ah BL1860B x2 + DC18RD + MakPac 3	198077-8	0088381474511	670,00
Kit de fonte de alimentação 5,0 Ah BL1850B x4 + DC18RD + MakPac 3	197626-8	0088381463164	824,00
Kit de fonte de alimentação XGT BL4025 x2 + DC40RA	191J39-5	0088381561006	479,00
Kit de fonte de alimentação XGT BL4040 x2 + DC40RA + MakPac 1	191J97-1	0088381561389	695,00
Kit de fonte de alimentação XGT BL4025 x2 + DC40RA + MakPac 1	191J81-6	0088381561228	505,00
Kit de fonte de alimentação XGT BL4050F x2 + DC40RB + MakPac 3	191U13-9	0088381583039	803,00
Kit de fonte de alimentação XGT BL4040 x2 + DC40RB + MakPac 3	191U00-8	0088381582902	711,00
KIT DE ALIMENTAÇÃO 40 V MÁX. 4,0 AH XGT BL4040X1 + DC40RA	191J65-4	0088381561068	386,00
Bateria 40 V máx. 5,0 Ah XGT - BL4050F	191L47-8	0088381580946	314,00
Bateria 40 V máx. 4,0 Ah XGT - BL4040	191B26-6	0088381557498	268,00
Bateria 40 V máx. 2,5 Ah XGT - BL4025	191B36-3	0088381556521	211,00
Bateria 40 V máx. 2,0 Ah XGT - BL4020	191L29-0	0088381574549	191,00

Descrição	Código	EAN	P.V.P (€)
Bateria 18 V 6,0 Ah LXT - BL1860B	197422-4	0088381464123	232,00
Bateria 18 V 5,0 Ah LXT - BL1850B	197280-8	0088381459129	201,00
Bateria 18 V 4,0 Ah LXT - BL1840B	197265-4	0088381459068	170,00
Bateria 18 V 3,0 Ah LXT - BL1830B	197599-5	0088381464055	144,00
Bateria 18 V 2,0 Ah LXT - BL1820B	197254-9	0088381459037	113,00
Bateria 18 V 1,5 Ah LXT - BL1815N	196235-0	0088381417556	93,00
Bateria 14,4 V 4,0 Ah LXT - BL1440	196388-5	0088381426671	165,00
Bateria 14,4 V 3,0 Ah LXT - BL1430B	197615-3	0088381465083	139,00
Bateria 14,4 V 1,5 Ah LXT - BL1415N	196875-4	0088381443746	110,00
Bateria 18 V 1,5 Ah - BL1815G	198186-3	0088381475891	72,00
Bateria 14,4 V 1,5 Ah - BL1415G	198192-8	0088381475952	62,00
Carregador de iões de lítio 18 V - DC18WA	195423-6	0088381371575	53,00
Bateria 12 V 4,0 Ah CXT - BL1041B	197406-2	0088381461658	91,00
Bateria 12 V 2,0 Ah CXT - BL1021B	197396-9	0088381459839	70,00
Carregador rápido 12 V CXT - DC10SB	197363-4	0088381459563	112,00
Carregador 12 V CXT - DC10WD	197343-0	0088381459211	77,00
Bateria de lítio 10,8 V - BL1013	196066-7	0088381405423	57,00
Carregador 10,8 V - DC10WA	194588-1	0088381348065	47,00
Bateria de lítio 7,2 V - BL0715	198000-3	0088381473392	52,00
Adaptador BMR100 - 383PCC0B11	SE00000078	0088381447829	16,50
Adaptador BCF201ZW	TEB0000006	3240890380852	32,00
Adaptador DMR106	SE00000101	0088381425162	24,00
Adaptador DMR115	SE00000679	-	31,00
Adaptador DMR100 - 3A8A12C133B11	SE00000501	0088381534826	14,40
Adaptador DF001DW - ADP07	198363-7	0088381525671	12,60
Adaptador 12-24 V DCW180	WL00000002	-	9,25
Adaptador 220 V DCW180	WL00000058	-	77,00
Carregador DC4001	191L00-4	0088381570688	196,00



Adaptadores

- PDC01



191J50-7

- PDC01
- PDC1200



191J51-5



191N62-4

- PDC01
- PDC1200



Para	Descrição	Un.	Código	EAN	P.V.P (€)
LXT	Adaptador simples LXT 18 V	1	191J50-7	0088381560375	124,00
LXT	Adaptador duplo LXT 18 V x 2	1	191J51-5	0088381560382	180,00
XGT	Adaptador simples XGT 40 V máx.	1	191N62-4	0088381580342	155,00

Adaptador de bateria para cinto BAP36N e BAP182

- Permite que a bateria seja separada da ferramenta, reduzindo assim o peso da máquina para uma menor fadiga do braço.



* Adaptador não adequado para BC231UD e UX361D.



Modelo	Para	Descrição	Un.	Código	EAN	P.V.P (€)
BAP36N *	36 V	Permite que a(s) bateria(s) seja(m) separada(s) da ferramenta e assim conseguimos reduzir o seu peso.	1	195311-7	0088381363181	72,00
BAP182	18 V x 2		1	197580-6	0088381463119	141,00

Conversor de bateria

- Com duas baterias de 18 V (BL1860B, BL1850B, BL1840B, BL1830B) as máquinas de 36 V podem ser usadas.

BCV01 *

18 V x 2



BCV03

18 V x 2



* Adaptador não adequado para BC231UD e UX361D.

Modelo	Para	Descrição	Un.	Código	EAN	P.V.P (€)
BCV01 *	36 V	Adaptador 2 baterias de 18 V para uma mala de 36 V + cabo + adaptador	1	195511-9	0088381371650	130,00
BCV03	36 V	Adaptador 2 baterias de 18 V a 36 V Adaptador diretamente na máquina	1	197214-1	0088381459013	115,00

Adaptadores USB



DEBADP05

Para	Descrição	Un.	Código	EAN	P.V.P (€)
LXT 18V	Adaptador para USB	1	DECADP05	-	30,00
CXT 12V	Adaptador para USB com gancho para cinto	1	DEAADP06	0088381825108	29,00
CXT 12V	Adaptador para USB	1	DEAADP08	0088381853224	29,00

Adaptador para baterias Ni-Cd/Ni.Mh



Para	V	Un.	Código	EAN	P.V.P (€)
Baterias Ni-Cd e Ni-MH	9,6 18 V	1	193947-6	0088381188395	47,00

Protetores de bateria à prova de pó e água

- Concebido para proteger a bateria do pó e da água em condições adversas.



Para	Indicado para	Un.	Código	EAN	P.V.P (€)
14,4V BL1430B BL1440B	Berbequins Aparafusadoras de impacto	1	195797-5	0088381376525	46,00
18 V BL1830B BL1840B BL1850B	Chaves de impacto	1	195798-3	0088381376532	48,00

Protetor de bateria

- Concebido para proteger a bateria contra pancadas acidentais e humidade.



Para	Un.	Código	EAN	P.V.P (€)
BL1830 BL1840 BL1850 BL1860	1	459938-0	-	7,70
BL1415	1	454407-6	-	4,65
BL1815 BL1820B	1	459937-2	-	6,20

Conectores de bateria para casacos



GM00001607



GM00001605



FE00000037



YL00000004

	Modelos	Un.	Código	EAN	P.V.P (€)
Casacos ventila- dos	LXT 18 V	1	198634-2	0088381486675	46,00
	CXT 12 V	1	GM00001605	0088381472975	45,00
Casacos aquecidos	LXT 18 V	1	YL00000004	0088381537094	44,00
	CXT 12 V	1	YL00000003	0088381537087	38,00

Sistema AWS



O sistema AWS (Automatic Wireless System) permite-nos conectar o aspirador no modo autoconectado com as máquinas que possuem AWS, iniciando somente quando ligamos a máquina sem a necessidade de cabos.



Descrição	Un.	Código	EAN	P.V.P (€)
Dispositivo AWS conexão por Bluetooth	1	198900-7	0088381497749	55,00

Filtro para casacos ventilados



Modelos	Un.	Código	EAN	P.V.P (€)
DFJ301Z DFJ201Z	1	GM00001499	0088381471299	23,00

Acessórios para pistola de silicone DCG180

A 196351-8



Desmontagem:

- Bocal A (tipo cartucho) 454275-7
- Junta do bocal A 454223-6
- Rack 42 142042-1
- Pistão A 142071-2

B 191P89-6/196352-6

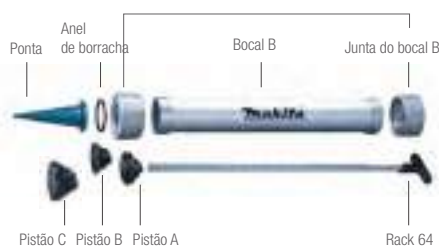

Desmontagem:

- Bocal B 141861-0
- Junta do bocal B 318958-2
- Anel de borracha 424547-4
- Ponta do bocal 454226-0
- Rack 64 142042-9
- Pistão A (tipo cartucho) 142071-2
- Pistão B (tipo salsicha) 142072-0
- Pistão C (vedante a granel) 123221-8

C 197195-9



Desmontagem:

- Bocal C 455951-6
- Junta do bocal C 455952-4
- Junta do bocal C (completa) 143223-8
- Pistão D (tipo cartucho) 143221-2
- Rack 53 143220-4



Capacidade	Tipo	Descrição	Un.	Código	EAN	P.V.P (€)
300 ml	A	Para colocar tubos de silicone de 300 ml	1	196351-8	0088381424271	43,00
400 ml	B	Para colocar silicone em salsichas ou a granel	1	191P89-6	0088381580915	89,00
600 ml	B		1	196352-6	0088381424288	98,00
800 ml	C	Para colocar tubos de silicone de 800 ml	1	197195-9	0088381458221	71,00

Bocal de silicone. Para os tipos B e C

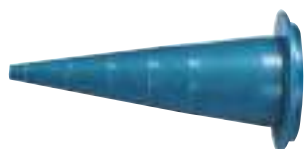

Tipo	Descrição	Un.	Código	EAN	P.V.P (€)
B C	Bocal de silicone recortável	1	454226-0	0088381437080	3,85

Acessórios para rebitoras



Conjunto de grampos para rebitoras



Descrição	Un.	Código	EAN	P.V.P (€)
Jogo de grampos para DRV150	1	199731-7	0088381568647	14,40
Jogo de grampos para DRV250	1	199730-9	0088381568630	14,40

Bocais para rebites DRV150/DRV250



Descrição	Modelo	Un.	Código	EAN	P.V.P (€)
2,4 mm	DRV150	1	199729-4	0088381567299	34,00
3,2 mm		1	199728-6	0088381567282	33,00
4,0 mm		1	191C04-2	0088381567275	16,50
4,8 mm		1	191C03-4	0088381567268	16,50
4,0 mm	DRV250	1	191F80-4	0088381567336	57,00
4,8 mm		1	191F79-9	0088381567329	27,00
6,0 mm		1	199725-2	0088381567312	27,00
6,4 mm		1	191F78-1	0088381567305	27,00

Acessórios para pistola lubrificante DGP180



Descrição	Un.	Código	EAN	P.V.P (€)
Depósito tipo B 450 g	1	191A81-2	0088381558440	92,00
Depósito tipo B 400 g	1	191B12-7	0088381558433	91,00
Depósito tipo A 400 g	1	191F24-4	0088381558464	72,00



Descrição	Un.	Código	EAN	P.V.P (€)
Tubo flexível 1200 mm	1	191A79-9	0088381558501	77,00
Tubo flexível 600 mm	1	191A80-4	0088381558518	62,00

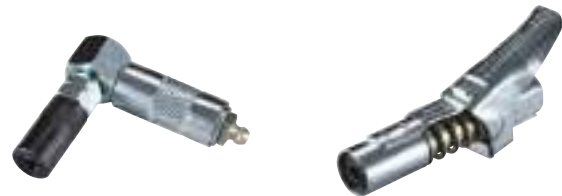

Descrição	Un.	Código	EAN	P.V.P (€)
Adaptador de bocal angular	1	191A77-3	0088381567213	73,00
Adaptador de bocal com bloqueio	1	191A76-5	0088381567206	129,00



Descrição	Un.	Código	EAN	P.V.P (€)
Conjunto de adaptadores (3 peças)	1	191A78-1	-	44,00

Jogo de arames para atadora de armadura passiva DTR180 e extensão de cabo



Extensão de cabo

- Extensão de cabo para DTR180 indicado para reduzir o esforço e a fadiga nas costas. Inclui também um guia do antebraço acolchoado.



* Ferramenta não incluída

Descrição	Un.	Código	EAN	P.V.P (€)
Cabo extensor	1	191M27-0	0088381572675	185,00



Descrição	Un.	Código	EAN	P.V.P (€)
Jogo de arame 50 rolos	1	199137-9	0088381533928	188,00



Descrição	Un.	Código	EAN	P.V.P (€)
Jogo de arame galvanizado 50 rolos	1	191A57-9	0088381547949	268,00



- 50 rolos de arame de 100 metros cada.
- Diâmetro do fio de 0,8 mm.

Descrição	Un.	Código	EAN	P.V.P (€)
Jogo de arame de poliéster 50 rolos	1	191J59-9	0088381560894	371,00

Acessórios para bombas de ar



TE00000333



TE00000334



TE00000335

Descrição	Un.	Código	EAN	P.V.P (€)
Bocal para bomba de ar <0,5 bares	1	TE00000333	0088381547918	0,80
Bocal para bomba de ar <0,7 bares	1	TE00000334	0088381547925	0,50
Bocal para bomba de ar <0,9 bares	1	TE00000335	0088381547932	0,55



ILUMINAÇÃO

40V Li-ion
max

XGT

18V
LITHIUM-ION

144V
LITHIUM-ION

LXT
Lithium EXTREMA TECNOLOGIA

12Vmax
LITHIUM-ION

CXT

Comparação de holofotes e lanternas

Modelo				Lúmenes	Iluminação/modos	AC/DC
DML810		✓		Alto - 5500 Lm Médio - 3000 Lm Baixo - 1500 Lm	Alto - 550 Lx Médio - 300 Lx Baixo - 150 Lx (a 1 m de distância)	SIM
DML814		✓		Alto - 3000 Lm Médio - 1700 Lm Baixo 900 Lm	Alto - 1250 Lx Médio - 750 Lx Baixo - 400 Lx (a 1 m de distância)	-
ML003GZ		✓	✓	Alto - 1100 Lm Baixo - 450 Lm	Alto - 500 Lx Baixo - 200 Lx (a 1 m de distância)	-
DEADML809			✓	Alto - 10 000 Lm Médio - 4000 Lm Baixo - 2000 Lm	Alto - 3800 Lx Médio - 1500 Lx Baixo - 800 Lx (a 1 m de distância)	SIM
DEADML805			✓	Alto - 750 Lm Baixo - 450 Lm	Alto - 300 Lx Baixo - 200 Lx (a 1 m de distância)	SIM
DML811			✓	Alto - 3000 Lm Médio - 1500 Lm Baixo - 750 Lm	Alto - 1800 Lx Médio - 800 Lx Baixo - 350 Lx (a 1 m de distância)	SIM
DML812			✓	Projetor - 600 Lm Lupa - 1000 Lm Misto - 1250 Lm	Spot - 71 000 Lx Flood - 520 Lx Spot-Flood - 51 000 Lm (a 1 m de distância)	-
ML001G		✓		160 Lm	3000 Lx (a 1 m de distância)	-
DEADML815			✓	160 Lm	3000 Lx (a 1 m de distância)	-
DEAML105			✓	190 Lm	5500 Lx (a 1 m de distância)	-
DEBDML808			✓	190 Lm	Alto - 4500 Lx Baixo - 170 Lx (a 1 m de distância)	-
DEBDML802			✓	180 Lm	4000 Lx (a 1 m de distância)	-
DEAML106			✓	190 Lm	Alto - 4500 Lx Baixo - 170 Lx (a 1 m de distância)	-
ML002		✓		360° - 710 Lm 180° - 340 Lm Modo lanterna 130 Lm		
DEAML104			✓	Luz principal - 710 Lm Luz secundária - 130 Lm		
ML006GX		✓		Alto - 500 Lm Médio - 250 Lm Baixo - 100 Lm	Alto - 500 Lx Médio - 250 Lx Baixo - 100 Lx (a 1 m de distância)	-
DML816X			✓	Alto - 500 Lm Médio - 250 Lm Baixo - 100 Lm	Alto - 800 Lx Médio - 400 Lx Baixo - 180 Lx (a 1 m de distância)	-
DEBDML806			✓	Luz principal - 620 Lm Luz secundária - 310 Lm	Luz principal - 310 Lm Luz secundária - 280 Lm	-
DEBDML801			✓	240 Lm	12 Leds - 240 Lm 6 Leds - 120 Lm	-
DEBDML800			✓	100 Lm	-	-
DEAML103			✓	100 Lm	-	-
DEBDML186			✓	6 Leds	500 Lx a 1 metro de distância	-

640 M
MODO SPOT

Distância

2,3 M

2,8 M

2,8 M

4,5 M

6 M

10 M

DML805

ML003G

DML812

DML814

DML811

DML810

DML809

6,5 M

Lanterna de área 5500 LM - DML810

- 3 configurações de luminosidade: 5500 lm alto, 3000 lm médio ou 1500 lm baixo.
- Aprox. 4 horas de iluminação contínua.
- Bloqueio da tampa da bateria para proteger a bateria contra o roubo.
- Capaz de conectar até 8 unidades DML810 em série.
- Controlador com função de memória
- Compartimento para duas baterias LXT.



Dimensões	Un.	Código	EAN	P.V.P (€)
420 x 420 x 787 mm	1	DML810	0088381891103	489,00

Tripé ajustável 3000 Lm- DML814

- 3 configurações de luminosidade: 3000, 1700 ou 900 Lm.
- 3 cabeças rotativas individuais.
- Luz LED branca, ideal para o trabalho.
- Os fechos têm um parafuso de ajuste.
- Tampa da bateria com cadeado.
- A porta da bateria está localizada à altura do meio da luz de trabalho.
- Controlo com função de memória que se lembra da última configuração de luminosidade.
- Dobrável num tamanho compacto para facilitar o armazenamento e o transporte.



Primeiro tripé de iluminação Makita



Dimensões	Un.	Código	EAN	P.V.P (€)
573 x 658 x 2.240 mm	1	DML814	0088381728614	422,00

Novos holofotes de iluminação

Luzes LED de alta intensidade para maior alcance. Até 10 horas de iluminação contínua. Com uma potência de até 10 000 lúmenes.

Compatível com baterias XGT e LXT



Holofote 1100 Lm - ML003G

- Função de memória na configuração de luminosidade.
- Classificação IP65 para resistência à água.
- Desenho compacto de 249 mm.



Dimensões	Un.	Código	EAN	P.V.P (€)
249 x 298 x 280 mm	1	ML003GZ	0088381746632	216,00

Holofote 10 000Lm - DEADML809

- Função de memória na configuração de luminosidade.
- Classificação IP65 para resistência à água.
- Desenho compacto de 249 mm.



Dimensões	Un.	Código	EAN	P.V.P (€)
249 x 370 x 370 mm	1	DEADML809	0088381888264	443,00



Descrição	Un.	Código	EAN	P.V.P (€)
Difusor de luz DML809	1	GM00002286	-	19,55
Tripé ajustável em altura 1,3 m a 2,0 m.		GM00002073	0088381548830	213,00

Holofote 750 Lm - DEADML805

- Muito leve. Asa em forma de gancho.
- Com a tecnologia XPT.



Dimensões	Un.	Código	EAN	P.V.P (€)
214 x 261 x 328 mm	1	DEADML805	0088381699303	174,00



Descrição	Un.	Código	EAN	P.V.P (€)
Fixação por gancho	1	GM00001396	0088381455688	20,10
Tripé	1	GM00002283	0088381579476	67,00

Holofote 3000 Lm - DML811

- Até 3 horas de iluminação contínua.
- Ajuste do ângulo de luz: -30° a 210°.



Dimensões	Un.	Código	EAN	P.V.P (€)
249 x 302 x 271 mm	1	DML811	-	294,00



Descrição	Un.	Código	EAN	P.V.P (€)
Difusor de luz DML811	1	GM00002287	-	13,40

Holofote manual 1250 LM - DML812

- 3 configurações de luminosidade: projector de 600 Lm, lupa de 1.000 Lm e 1.250 Lm misturados.
- 3 níveis de iluminância: 71.000 L x projector, 500 L x lupa e 51.000 L x misturados. *
- 4 modos de iluminação: holofote, fixo, misto e estroboscópico.
- Distância do feixe de até 640 m no modo fixo.
- Temperatura de cor de aproximadamente 5000K.
- A cabeça da lanterna gira a 90°.
- Tempo de iluminação: 10H em modo de projector com BL1860B.



Dimensões	Un.	Código	EAN	P.V.P (€)
313 x 119 x 115 mm	1	DML812	-	149,00

Lanterna manual 100 LM - DEAML103

- 1 configurações de luminosidade: 100 Lm,
- 1 nível de luminosidade: 240 Lx. *
- O tamanho compacto adapta-se à mão.
- Tempo de iluminação: 28 H com BL1041B.



Dimensões	Un.	Código	EAN	P.V.P (€)
87 x 64 x 73mm	1	DEAML103	0088381818636	29,00

Lanterna manual - DEBDML186

- 6 luzes LED.
- 1 nível de luminosidade: 500 Lx. *
- Tempo de iluminação: 50 H com BL1830B.



Dimensões	Un.	Código	EAN	P.V.P (€)
151 x 81 x 61mm	1	DEBDML186	-	24,00

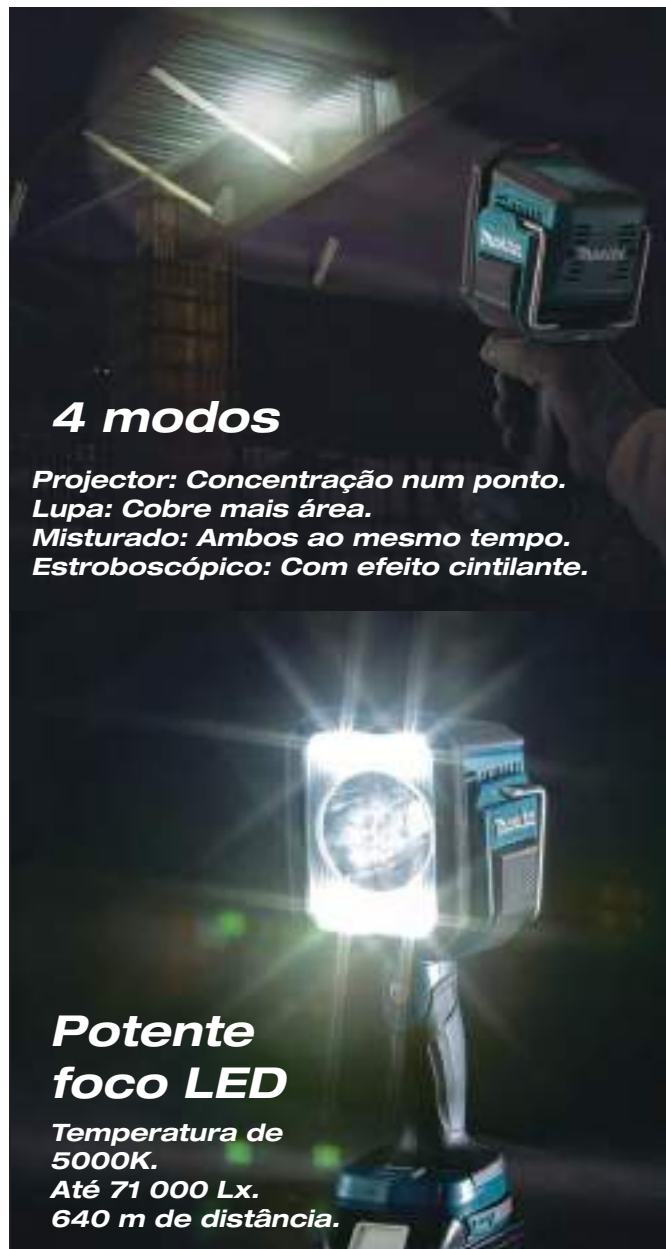

4 modos

**Projector: Concentração num ponto.
Lupa: Cobre mais área.
Misturado: Ambos ao mesmo tempo.
Estroboscópico: Com efeito cintilante.**

Potente foco LED

**Temperatura de 5000K.
Até 71 000 Lx.
640 m de distância.**

Lanterna para cabeça 100 LM - DEBDML800

- 1 configurações de luminosidade: 100 Lm.
- 1 nível de luminosidade: 2 000 Lx. *
- 7 posições da cabeça.
- Classificação IP65 para resistência à água.
- Tempo de Iluminação: até 20 H com BL1830B.



Dimensões	Un.	Código	EAN	P.V.P (€)
151 x 76 x 88mm	1	DEBDML800	-	46,00

NOVA GAMA DE LANTERNAS

Com um tempo de trabalho superior aos modelos LXT e CXT. Concebidas para trabalhos profissionais de uso prolongado.



Lanterna 160 LM - ML001G

- 1 configuração + Lanterna 160 LM
- 1 nível de luminosidade: 3 000 Lx. *
- Cabeça pivotante com 12 posições de 0° a 170°.
- Tempo de iluminação: até 55 H com BL4040.



Dimensões	Un.	Código	EAN	P.V.P (€)
287 x 88 x 136mm	1	ML001G	-	50,00

Lanterna 160 LM - DEBDML815

- 1 configuração + Lanterna 180 LM
- 1 nível de luminosidade: 3 000 Lx. *
- Até 12 posições de foco
- Tempo de iluminação: até 45 H com BL1850B.



Dimensões	Un.	Código	EAN	P.V.P (€)
272 x 79 x 116mm	1	DEBDML815	-	39,00

Lanterna 190 LM - DEBML105

- 1 configuração + Lanterna 190 LM
- 1 nível de luminosidade: 5.500 Lx. *
- Até 12 posições de foco
- Multirrefletor, que controla a direção.
- Cabeça compacta fabricada em alumínio.
- Tempo de iluminação: 14 H com BL1041B.



Dimensões	Un.	Código	EAN	P.V.P (€)
268 x 66 x 93mm	1	DEBML105	0088381836180	58,00

Lanterna 190 LM - DEADML808

- 1 configuração + Lanterna 190 LM
- Nível de iluminação de 170- 4 500 Lx. *
- Cabeça pivotante com 12 posições de 0° a 170°.
- Função de zoom que ajusta o alcance de iluminação.
- Tempo de iluminação: 32 H com BL1860B.



Dimensões	Un.	Código	EAN	P.V.P (€)
297 x 79 x 119mm	1	DEBDML808	-	62,00

Lanterna 180 LM - DEBDML802

- 1 configuração + Lanterna 180 LM
- 1 nível de luminosidade: 4 000 Lx. *
- Até 12 posições de foco
- Tempo de iluminação: até 23 H com BL1850B.



Dimensões	Un.	Código	EAN	P.V.P (€)
272 x 79 x 116mm	1	DEBDML802	0088381675758	55,00

Lanterna 190 LM - DEAML106

- 1 configuração + Lanterna 190 LM
- Nível de iluminação: 170-4.500 Lx. *
- Função de zoom que ajusta o alcance de iluminação.
- Acessório magnético opcional.
- Refletor multifacetado que ilumina de forma uniforme.
- Tempo de iluminação: 12 H com BL1041B.



Dimensões	Un.	Código	EAN	P.V.P (€)
290 x 66 x 93mm	1	DEAML106	0088381853125	62,00

Lanterna tubular 710 LM - ML002G

- 3 configurações de luminosidade: 710 Lm "modo 360°", 340 Lm modo 180° e 130 Lm modo de iluminação frontal.
- 3 níveis de iluminância: 340 Lx modo 360°, 310 Lx modo 180° e 1.900 Lx modo de iluminação frontal. *
- Interruptor com função de desligamento automático.
- Com porta USB integrada.
- Tempo de iluminação: 16 H luz principal com BL4040B. (Não utilização de USB)



Dimensões	Un.	Código	EAN	P.V.P (€)
431 x 86 x 175mm	1	ML002G	-	118,00

Lanterna tubular 710 LM - DEAML104

- 3 configurações de luminosidade: 710 Lm modo 360°, 190 Lm modo 180° e 130 Lm modo de iluminação frontal.
- 3 níveis de iluminância: 340 Lx modo 360°, 190 Lx modo 180° e 1.900 Lx modo de iluminação frontal. *
- Porta USB integrada. Gancho retráctil para pendurar.
- Acessório magnético opcional para operação mãos-livres.
- Tempo de iluminação: 17 H luz principal com BL1041B. (Não utilização de USB)



Dimensões	Un.	Código	EAN	P.V.P (€)
414 x 66 x 132mm	1	DEAML104	0088381836173	102,00

Lanterna de farol 500 LM - ML006GX

- 3 configurações de luminosidade: 500 / 250 / 100 Lm.
- 3 níveis de iluminância: 800 / 400 / 180 Lx.*
- Cabeça com 7 posições.
- Gancho retráctil para pendurar.
- Tempo de iluminação: 20 H em modo alto com BL4040.



Dimensões	Un.	Código	EAN	P.V.P (€)
429 x 82 x 168 mm	1	ML006GX	-	84,00

Lanterna tubular 620 LM - DEBDML806

- 3 configurações de luminosidade: 620 Lm modo 360°, 310 Lm modo 180° e 90 Lm modo de iluminação frontal.
- 3 níveis de iluminância: 310 Lx modo 360°, 280 Lx modo 180° e 2.100 Lx modo de iluminação frontal. *
- 3 opções de utilização: modo 360°, modo 180° e modo de iluminação frontal.
- Tempo de iluminação: 21 H no feixe principal com BL1850B.



Dimensões	Un.	Código	EAN	P.V.P (€)
365 x 78 x 119mm	1	DEBDML806	-	77,00

Lanterna de farol 500 LM - DML816X

- 3 configurações de luminosidade: 500 Lm / 250 / 100 Lm.
- 3 níveis de iluminância: 800 / 400 Lx / 180 Lx. *
- Temperatura de cor de 5000K.
- 7 posições da cabeça que gira para a esquerda e para a direita.
- Tempo de iluminação: 17 H em modo alto com BL1860B.



• Inclui o acessório difusor GM00001326

Dimensões	Un.	Código	EAN	P.V.P (€)
400 x 79 x 127mm	1	DML816X	-	77,00

Lanterna de farol 240 LM - DEBDML801

- 2 configurações de luminosidade: 240 Lm / 120 Lm.
- 2 níveis de iluminância: 400 / 200 Lx. *
- Dobrável e com gancho giratório de 360°.
- 7 posições da cabeça que gira para a esquerda e para a direita.
- Tempo de iluminação: 9 H em modo completo com BL1830B.



Dimensões	Un.	Código	EAN	P.V.P (€)
380 x 79 x 116mm	1	DEBDML801	-	48,00

Perfuração e Percussão

Inserção SDS - PLUS 

Inserção SDS - MAX 

Makita Hexagonal 17 mm 

Makita Hexagonal 19 mm 

Makita Hexagonal 21 mm 

Makita Hexagonal 28,6 mm 

Makita Hexagonal 30 mm 

B Hexagonal 19 mm 

K Hexagonal 21 mm 



MAK 4



MEMESSE II



Brocas SDS-PLUS **NEMESIS II**

Resolve problemas

Nota: quando encontramos hastes no betão armado, elas não precisam de ser apertadas. Deixar a broca cortar com uma leve pressão.



4 x 90°, a broca corta uniformemente através do metal e não se bloqueia com as hastes de aço reforçado.



Núcleo da espiral melhorado. Garante baixas vibrações e excepcional resistência à rutura.



A ponta centralizadora facilita a perfuração do material com uma precisão milimétrica.



O desenho simétrico das 4 espirais garante um desgaste baixo e uniforme.



A ampla geometria das espirais permite um transporte ideal da pó da perfuração.

A espiral

O seu desenho em espiral de quatro saídas garante que a carga de perfuração é distribuída uniformemente ao longo do eixo da broca. O aço de alta qualidade e o tratamento especial da superfície garantem a resistência da broca.

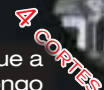

Brocas de 5 a 16 mm.



Ø (mm)	Comprimento (mm)	Compr. útil (mm)	Un.	Código	EAN	P.V.P. (€)
5	115	50	1	B-57897	0088381520782	4,95
5	165	100	1	B-57906	0088381520799	5,20
5	215	150	1	B-57912	0088381520805	8,05
5	265	200	1	B-57928	0088381520812	8,30
5,5	115	50	1	B-57940	0088381520836	4,95
5,5	165	100	1	B-57956	0088381520843	5,20
6	115	50	1	B-57962	0088381520850	4,95
6	165	100	1	B-57978	0088381520867	5,20
6	215	150	1	B-57984	0088381520874	6,75
6	265	200	1	B-57990	0088381520881	8,05
6	315	250	1	B-58001	0088381520898	11,15
6,5	165	100	1	B-58023	0088381520911	7,00
6,5	215	150	1	B-58039	0088381520928	9,10
6,5	265	200	1	B-58045	0088381520935	11,40
6,5	315	250	1	B-58051	0088381520942	13,80
7	115	50	1	B-58067	0088381520959	6,25
7	165	100	1	B-58073	0088381520966	7,00
7	215	150	1	B-58089	0088381520973	10,15
8	115	50	1	B-58095	0088381520980	5,70
8	165	100	1	B-58104	0088381520997	5,95
8	215	150	1	B-58110	0088381521000	7,00
8	265	200	1	B-58126	0088381521017	8,30
8	315	250	1	B-58132	0088381521024	11,40
8	465	400	1	B-58154	0088381521048	18,20
9	165	100	1	B-58176	0088381521062	6,50
10	115	50	1	B-58198	0088381521086	5,95
10	165	100	1	B-58207	0088381521093	6,75
10	215	150	1	B-58213	0088381521109	7,55
10	265	200	1	B-58229	0088381521116	8,85
10	315	250	1	B-58235	0088381521123	11,45
10	455	390	1	B-58257	0088381521147	19,20
10	600	540	1	B-58263	0088381521154	26,00
10	1000	940	1	B-58279	0088381521161	63,00
11	160	100	1	E-14495	0088381594097	7,70
11	210	160	1	E-14504	0088381594103	9,25
11	260	210	1	E-14510	0088381594110	10,80
11	310	260	1	E-14526	0088381594127	14,95
12	160	110	1	E-14532	0088381594134	7,20

Brocas de 18 a 32 mm.



Ø (mm)	Comprimento (mm)	Compr. útil (mm)	Un.	Código	EAN	P.V.P. (€)
12	210	160	1	E-14548	0088381594141	8,75
12	260	210	1	E-14554	0088381594158	9,80
12	310	260	1	E-14560	0088381594165	13,90
12	450	400	1	E-14576	0088381594172	21,00
12	600	550	1	B-58372	0088381521260	26,00
12	1000	950	1	B-58388	0088381521277	63,00
14	160	110	1	E-14635	0088381594233	10,30
14	210	160	1	E-14641	0088381594240	13,90
14	260	210	1	E-14657	0088381594257	15,95
14	310	260	1	E-14663	0088381594264	17,00
14	450	400	1	E-14679	0088381594271	22,00
14	600	550	1	E-14685	0088381594288	29,00
14	1000	950	1	B-58497	0088381521383	65,00
15	160	110	1	E-14691	0088381594295	15,95
15	210	160	1	E-14700	0088381594301	18,00
15	260	210	1	E-14716	0088381594318	19,55
15	450	400	1	E-14722	0088381594325	26,00
16	160	110	1	E-14738	0088381594332	16,50
16	210	160	1	E-14744	0088381594349	18,55
16	260	210	1	E-14750	0088381594356	21,00
16	310	260	1	E-14766	0088381594363	23,00
16	450	400	1	E-14772	0088381594370	29,00
16	600	550	1	B-58590	0088381521482	36,00
16	1000	950	1	B-58609	0088381521499	75,00
18	250	200	1	B-58615	0088381521505	27,00
18	450	400	1	B-58621	0088381521512	31,00
20	250	200	1	B-58637	0088381521529	30,00
20	450	400	1	B-58659	0088381521543	36,00
22	250	200	1	B-58665	0088381521550	34,00
22	450	400	1	B-58687	0088381521574	45,00
24	250	200	1	B-58693	0088381521581	43,00
24	450	400	1	B-58702	0088381521598	49,00
25	250	200	1	B-58718	0088381521604	43,00
25	450	400	1	B-58724	0088381521611	54,00
28	250	200	1	B-58746	0088381521635	49,00
28	450	400	1	B-58752	0088381521642	63,00
30	250	200	1	B-58768	0088381521659	55,00
30	450	400	1	B-58774	0088381521666	69,00
32	450	400	1	B-58780	0088381521673	89,00

* A partir de 18 mm, as brocas são de 3 peças de carboneto.

NOVA gama de brocas SDS-V-PLUS MAK4.

Para martelos SDS-PLUS. Brocas com cabeça de 4 pontas.

Pode perfurar em betão armado. Furos mais **PRECISOS** do que com brocas de 2 pontas.

Indicadas para todos os tipos de trabalho onde são utilizados martelos leves SDS-PLUS.



Brocas de 5 a 25 mm.



Ø (mm)	Comprimento (mm)	Compr. útil (mm)	Un.	Código	EAN	P.V.P. (€)
5	110	50	1	B-68127	0088381544696	2,60
5	160	100	1	B-68133	0088381544702	2,60
6	110	50	1	B-62496	0088381529938	3,15
6	160	100	1	B-62505	0088381529945	3,15
6	210	150	1	B-62511	0088381529952	3,75
6	260	200	1	B-62527	0088381529969	4,05
8	110	50	1	B-62608	0088381530040	3,85
8	160	100	1	B-62614	0088381530057	3,85
8	210	150	1	B-62620	0088381530064	4,40
8	260	200	1	B-62636	0088381530071	4,90
8	310	250	1	B-62642	0088381530088	5,20
10	110	50	1	B-62664	0088381530101	5,15
10	160	100	1	B-62670	0088381530118	5,15
10	210	150	1	B-62686	0088381530125	5,65
10	260	200	1	B-62692	0088381530132	6,20
10	310	250	1	B-62701	0088381530149	6,45
12	160	100	1	B-62739	0088381530170	6,95
12	210	150	1	B-62745	0088381530187	7,45
12	260	200	1	B-62751	0088381530194	8,00
12	310	250	1	B-62767	0088381530200	8,25
12	350	290	1	B-62773	0088381530217	9,25
14	160	100	1	B-62795	0088381530231	10,30
14	210	150	1	B-62804	0088381530248	10,80
14	260	200	1	B-62810	0088381530255	11,35
14	310	250	1	B-62826	0088381530262	11,60
14	350	290	1	B-62832	0088381530279	11,85
16	160	100	1	B-62854	0088381530293	12,35
16	210	150	1	B-62860	0088381530309	12,90
16	260	200	1	B-62876	0088381530316	13,50
16	310	250	1	B-62882	0088381530323	14,65
16	350	290	1	B-62898	0088381530330	15,20
18	260	200	1	B-68177	0088381544740	19,60
18	460	400	1	B-68236	0088381544801	24,00
20	260	200	1	B-68183	0088381544757	25,00
20	460	400	1	B-68242	0088381544818	29,00
22	260	200	1	B-68199	0088381544764	31,00
22	460	400	1	B-68258	0088381544825	38,00
25	260	200	1	B-68208	0088381544771	39,00
25	460	400	1	B-68264	0088381544832	42,00



• **Potência de rutura.**

Efeito de demolição.
Produz microrroturas na perfuração.
Gera maior velocidade de perfuração.

• **Reduz o atrito nas laterais para aumentar a velocidade.**



• **Duração em betão armado.**

Maior duração (+35 %).
Evita danos na pastilha quando atinge a haste.
Reduz a probabilidade de engate durante a perfuração.

• **Flauta KVS.**

Geometria cônica da flauta.
Assim, oferece alta velocidade e resistência à rutura.

• **Pastilha centralizadora.**

• **Alta durabilidade.**

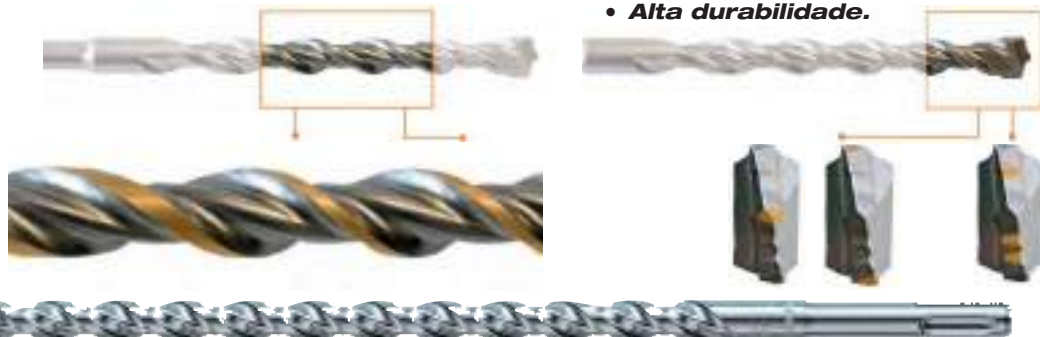

Ø (mm)	Comprimento (mm)	Compr. útil (mm)	Un.	Código	EAN	P.V.P. (€)
3,5	110	50	1	E-10665	0088381580434	5,70
4	110	50	1	B-47232	0088381454315	3,15
4	160	100	1	B-47248	0088381454322	3,65
4,5	160	100	1	E-10671	0088381580441	5,70
5	110	50	1	B-46492	0088381452427	2,60
5	160	100	1	B-46501	0088381452434	2,85
5,5	110	50	1	B-47298	0088381454377	2,60
5,5	160	100	1	B-47307	0088381454384	3,35
5,5	210	150	1	B-47313	0088381454391	5,95
6	110	50	1	B-46517	0088381452441	2,60
6	160	100	1	B-46523	0088381452458	2,60
6	210	150	1	B-47341	0088381454421	3,90
6	260	200	1	B-47357	0088381454438	4,95
6,5	110	50	1	B-47385	0088381454469	2,85
6,5	160	100	1	B-47391	0088381454476	3,35
6,5	210	150	1	B-47400	0088381454483	4,40
6,5	260	200	1	B-47416	0088381454490	5,95
7	110	50	1	B-47438	0088381454513	2,85
7	160	100	1	B-47444	0088381454520	3,15
7	210	150	1	B-47450	0088381454537	4,70
8	110	50	1	B-46539	0088381452465	2,85
8	160	100	1	B-46545	0088381452472	3,15
8	210	150	1	B-47472	0088381454551	4,15
8	260	200	1	B-47488	0088381454568	5,20
8	400	340	1	B-47503	0088381454582	9,85
8	600	540	1	B-47525	0088381454605	14,55
9	160	100	1	B-47531	0088381454612	3,90
9	210	150	1	B-47547	0088381454629	5,20
9,5	160	100	1	B-47553	0088381454636	4,40
10	110	50	1	B-46551	0088381452489	3,40
10	160	100	1	B-46567	0088381452496	3,65
10	210	150	1	B-47569	0088381454643	4,90
10	260	200	1	B-47575	0088381454650	5,70
10	310	250	1	B-47581	0088381454667	6,50
10	450	390	1	B-47606	0088381454681	10,90

Ø (mm)	Comprimento (mm)	Compr. útil (mm)	Un.	Código	EAN	P.V.P. (€)
10	600	540	1	B-47612	0088381454698	15,05
10	1000	940	1	B-47634	0088381454711	38,00
11	160	110	1	B-47640	0088381454728	5,45
11	210	160	1	B-47656	0088381454735	6,00
11	260	210	1	B-47662	0088381454742	7,25
12	160	110	1	B-46573	0088381452502	4,40
12	210	160	1	B-47684	0088381454766	5,45
12	260	210	1	B-47690	0088381454773	6,75
12	310	260	1	B-47709	0088381454780	8,60
12	450	400	1	B-47721	0088381454803	11,95
12	600	550	1	B-47737	0088381454810	15,60
12	1000	950	1	B-47759	0088381454834	41,00
13	160	110	1	B-47765	0088381454841	5,45
13	210	160	1	B-47771	0088381454858	6,25
13	260	210	1	B-47787	0088381454865	7,25
13	310	260	1	B-47793	0088381454872	9,35
14	160	110	1	B-46589	0088381452519	6,00
14	210	160	1	B-47802	0088381454889	6,75
14	260	210	1	B-47818	0088381454896	8,35
14	310	260	1	B-47824	0088381454902	9,35
14	450	400	1	B-47830	0088381454919	14,55
14	600	550	1	B-47846	0088381454926	17,15
14	1000	950	1	B-47852	0088381454933	42,00
15	160	110	1	B-47868	0088381454940	7,55
15	210	160	1	B-47874	0088381454957	8,80
15	260	210	1	B-47880	0088381454964	9,60
15	450	400	1	B-47896	0088381454971	15,10
16	160	110	1	B-47905	0088381454988	7,30
16	210	160	1	B-47911	0088381454995	8,85
16	310	260	1	B-47933	0088381455015	11,45
16	450	400	1	B-47949	0088381455022	17,15
16	600	550	1	B-47955	0088381455039	21,00
16	800	750	1	B-47961	0088381455046	31,00
16	1000	950	1	B-47977	0088381455053	48,00
17	210	160	1	B-47983	0088381455060	13,50

Brocas SDS-PLUS StandMak



Ø (mm)	Comprimento (mm)	Compr. útil (mm)	Un.	Código	EAN	P.V.P. (€)
3,5	110	50	1	D-15665	0088381170079	1,15
4	110	50	1	D-00016	0088381169004	1,20
5	110	50	1	D-00022	0088381169011	1,20
5	160	100	1	D-00038	0088381169028	1,20
5,5	110	50	1	D-00044	0088381169035	1,20
5,5	160	100	1	D-16106	0088381187381	1,20
6	110	50	1	D-00050	0088381169042	1,20
6	160	100	1	D-00066	0088381169059	1,20
6	210	150	1	D-00072	0088381169066	1,50
6,5	110	50	1	D-00088	0088381169073	1,20
6,5	160	100	1	D-00094	0088381169080	1,20
7	110	50	1	D-00103	0088381169097	1,20
7	160	100	1	D-00119	0088381169103	1,20
8	110	50	1	D-00125	0088381169110	1,20
8	160	100	1	D-00131	0088381169127	1,20
8	210	150	1	D-00147	0088381169134	1,50
8	260	200	1	D-00153	0088381169141	1,85
9	160	100	1	D-08056	0088381182379	1,50
9	210	150	1	D-00169	0088381169158	1,50
9,5	210	150	1	D-03274	0088381173520	1,50
10	160	100	1	D-00175	0088381169165	1,50
10	210	150	1	D-00181	0088381169172	1,80
10	260	200	1	D-00197	0088381169189	1,80
10	310	250	1	D-00206	0088381169196	2,40
10	460	400	1	D-17538	0088381196574	4,25
12	160	100	1	D-00228	0088381169219	1,50
12	210	150	1	D-00234	0088381169226	1,80
12	260	200	1	D-00240	0088381169233	1,80
12	460	400	1	D-16271	0088381187558	4,55
13	160	100	1	D-00256	0088381169240	1,75
13	350	290	1	D-16128	0088381187404	2,75
14	160	100	1	D-00262	0088381169257	1,85
14	260	200	1	D-00278	0088381169264	2,45
14	460	400	1	D-17544	0088381196581	4,90
16	210	150	1	D-00290	0088381169288	3,45
16	310	250	1	D-00309	0088381169295	4,25
16	460	400	1	D-16287	0088381187565	5,75
18	210	150	1	D-00321	0088381169318	3,35
18	300	240	1	D-00337	0088381169325	4,30
18	460	400	1	D-17566	0088381196604	6,70
20	210	150	1	D-00359	0088381169349	4,25
20	310	250	1	D-00365	0088381169356	6,95
20	460	400	1	D-15235	0088381186339	7,20
22	260	200	1	D-00371	0088381169363	5,50

Ø (mm)	Comprimento (mm)	Compr. útil (mm)	Un.	Código	EAN	P.V.P. (€)
22	310	250	1	D-08062	0088381182386	6,65
22	460	400	1	D-15241	0088381186346	7,95
24	460	400	1	D-16302	0088381187589	9,10
25	260	200	1	D-00387	0088381169370	7,20
25	310	250	1	D-08517	0088381182454	8,55
25	460	400	1	D-15257	0088381186353	10,40
26	260	200	1	D-00393	0088381169387	9,80
26	460	400	1	D-15263	0088381186360	11,55
28	460	400	1	D-16318	0088381187596	16,45
30	460	400	1	D-17572	0088381196611	19,90

Brocas SDS-PLUS StandMak



- **Caixas de 25 unidades.**



* Fornecidas em caixa de cartão. Brocas soltas.

Ø (mm)	Comprimento (mm)	Compr. útil (mm)	Un.	Código	EAN	P.V.P. (€)
5	110	50	25	D-01155-25	0088381170598	21,65
6	110	50	25	D-01161-25	0088381170604	23,00
6	160	100	25	D-01177-25	0088381170611	28,00
8	160	100	25	D-01183-25	0088381170628	28,00
8	210	150	25	D-01199-25	0088381170635	35,00
10	160	100	25	D-01208-25	0088381170642	28,00
10	210	150	25	D-03707-25	0088381173995	38,00
12	160	100	25	D-03713-25	0088381174008	34,00
12	210	150	25	D-03729-25	0088381174015	38,00



Estojo SDS-PLUS Némesis (7 peças)



NEMESIS II



Ø (mm)	Comprimento (mm)	Compr. útil (mm)	Un.	Código	EAN	P.V.P. (€)
5	110	50	1	E-14928	-	48,00
6	110	50	1			
8	110	50	1			
6	160	100	1			
8	160	100	1			
10	160	100	1			
12	160	100	1			



Estojo SDS-PLUS Némesis (3 peças)



NEMESIS II



Ø (mm)	Comprimento (mm)	Compr. útil (mm)	Un.	Código	EAN	P.V.P. (€)
6	160	100	1	B-59075	0088381521963	19,20
8	160	100	1			
10	160	100	1			

Estojo SDS-V-PLUS (13 peças)



MAK 4



Ø (mm)	Comprimento (mm)	Compr. útil (mm)	Un.	Código	EAN	P.V.P. (€)
6	110	50	1	B-64674	0088381535762	88,00
6	160	100	1			
7	110	50	1			
7	160	100	1			
8	110	50	1			
8	160	100	1			
10	110	50	1			
10	160	100	1			
12	160	100	1			
14	160	100	1			
16	160	100	1			
Ponteiro 250 mm			1			
Cinzel 20 x 250 mm			1			

Estojo SDS-V-PLUS (5 peças)



MAK 2



Ø (mm)	Comprimento (mm)	Compr. útil (mm)	Un.	Código	EAN	P.V.P. (€)
5	110	50	1	B-49052	0088381457460	14,55
6	110	50	1			
8	110	50	1			
6	160	100	1			
8	160	100	1			

Estojo V-PLUS (7 peças)



MAK 2



Estojo SDS-PLUS StandMak (4 peças)



Ø (mm)	Comprimento (mm)	Compr. útil (mm)	Un.	Código	EAN	P.V.P. (€)
5	110	50	1	B-49046	0088381457453	29,00
6	110	50	1			
8	110	50	1			
6	160	100	1			
8	160	100	1			
10	160	100	1			
12	160	100	1			

Ø (mm)	Comprimento (mm)	Compr. útil (mm)	Un.	Código	EAN	P.V.P. (€)
6,5	160	100	1	D-74728	-	8,25
8	160	100	1			
10	160	100	1			
12	160	100	1			
5	110	50	1	D-74136	0088381587174	8,25
6	160	100	1			
8	160	100	1			
10	160	100	1			



Estojo StandMak SDS-PLUS (5 peças)



Ø (mm)	Comprimento (mm)	Compr. útil (mm)	Un.	Código	EAN	P.V.P. (€)
5	110	50	1	D-00795	0088381171182	5,45
6	110	50	1			
8	110	50	1			
6	160	100	1			
8	160	100	1			

Jogo de demolição e brocas Standmak



Ø (mm)	Comprimento (mm)	Compr. útil (mm)	Un.	Código	EAN	P.V.P. (€)
5	110	50	1	D-19180	0088381253826	56,00
6	110	50	1			
8	110	50	1			
10	110	100	1			
6	160	100	1			
8	160	100	1			
10	160	100	1			
12	160	100	1			
8	210	140	1			
10	210	140	1			
12	260	175	1			
14	260	175	1			
Ponteiro 14 x 140 mm			1			
Ponteiro 14 x 250 mm			1			
Cinzel 20 x 140 mm			1			
Cinzel 20 x 250 mm			1			
Espátula 40 x 250 mm			1			

Brocas de coroa SDS-PLUS

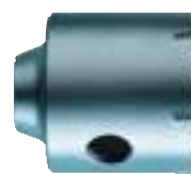

Ø (mm)	Comprimento (mm)	Un.	Código	EAN	P.V.P. (€)
40	60	1	P-26191	0088381953092	41,00
50	60	1	P-26200	0088381953108	54,00
65	60	1	P-26216	0088381953115	55,00
80	60	1	P-26222	0088381953122	61,00

Broca centradora

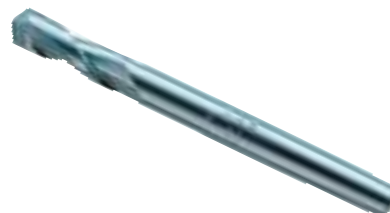

Ø (mm)	Comprimento (mm)	Ponta	Un.	Código	EAN	P.V.P. (€)
8	120	TCT	1	P-64347	0088381994866	6,25

Adaptador



Rosca (mm)	Comprimento (mm)	Un.	Código	EAN	P.V.P. (€)
M16	105	1	P-67745	0088381998277	21,00
M16	370	1	P-67751	0088381998284	32,00



Brocas de coroa para alvenaria



★★

Ø (mm)	Comprimento (mm)	Un.	Código	EAN	P.V.P. (€)
30	50	1	D-73891	0088381586801	7,20
35	50	1	D-73900	0088381586818	7,70
40	50	1	D-73916	0088381586825	8,00
50	50	1	D-73922	0088381586832	9,30
68	50	1	D-73938	0088381586849	12,10
82	50	1	D-73944	0088381586856	16,50
90	50	1	D-73950	0088381586863	19,55
100	50	1	D-73966	0088381586870	22,00

Jogo broca + adaptador



★★

Ø (mm)	Comprimento (mm)	Un.	Código	EAN	P.V.P. (€)
68	175	1	D-74011	0088381586924	18,50
82	175	1	D-74027	0088381586931	22,00

Broca centradora



★★



Ø (mm)	Comprimento (mm)	Un.	Código	EAN	P.V.P. (€)
8	110	1	D-73972	0088381586887	1,65

Adaptadores



★★

Ø (mm)	Comprimento (mm)	Un.	Código	EAN	P.V.P. (€)
110	110	1	D-73988	0088381586894	3,90
200	200	1	D-73994	0088381586900	5,90
350	350	1	D-74005	0088381586917	8,25



Makita

Brocas SDS-MAX



Mais precisão, menos vibração, mais potência de perfuração.

- Três peças de carboneto com uma geometria de corte única.

Ângulo da pastilha modificado.

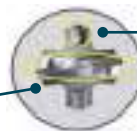

Pastilha biselada em pontos diferentes.

MAK 4

- A geometria renovada da broca de 4 x 90° evita o engate da pastilha de carboneto no betão armado. Pastilhas laterais muito robustas com forma de corte curva que apoiam a pastilha central nos cortes rápidos.
- Ponto de centragem de 130° para facilitar o início da perfuração e garantir uma orientação perfeita.
- Cada pastilha lateral é marcada com uma linha que indica o desgaste, para podermos avaliar a precisão dos furos de ancoragem.
- Pastilhas de carboneto perfeitamente soldadas ao corpo de aço da broca.
- Ponta de carboneto de grandes dimensões com tecnologia patenteada de chanfragem lateral* para uma ótima perfuração em betão armado.

*A partir de \varnothing 32 mm.

- O desenho da cabeça da broca confere-lhe uma elevada dureza, o que facilita um efeito de demolição agressivo e uma elevada velocidade de perfuração.
- Desenho patenteado da espiral com ótimo desempenho entre a extração de pó e a resistência à rutura.

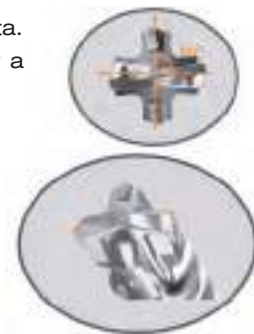

Ø (mm)	Comprimento (mm)	Compr. útil (mm)	Un.	Código	EAN	P.V.P. (€)
16	340	200	1	P-77730	0088381708487	36,00
16	540	400	1	P-77746	0088381708494	43,00
16	1320	1180	1	P-77768	0088381708517	151,00
18	340	200	1	P-77774	0088381708524	41,00
18	540	400	1	P-77780	0088381708531	45,00
18	1320	1180	1	P-77805	0088381708555	154,00
20	320	200	1	P-77811	0088381708562	41,00
20	520	400	1	P-77827	0088381708579	47,00
20	920	800	1	P-77833	0088381708586	68,00
22	320	200	1	P-77855	0088381708609	46,00
22	520	400	1	P-77861	0088381708616	50,00
22	920	800	1	P-77877	0088381708623	72,00
22	1320	1200	1	P-77883	0088381708630	167,00
24	320	200	1	P-77899	0088381708647	49,00
24	520	400	1	P-77908	0088381708654	56,00
25	320	200	1	P-77914	0088381708661	48,00
25	520	400	1	P-77920	0088381708678	56,00
25	920	800	1	P-77936	0088381708685	84,00
26	520	400	1	P-77958	0088381708708	61,00
28	370	250	1	P-77964	0088381708715	53,00

Ø (mm)	Comprimento (mm)	Compr. útil (mm)	Un.	Código	EAN	P.V.P. (€)
28	570	450	1	P-77970	0088381708722	64,00
28	670	550	1	P-77986	0088381708739	82,00
28	920	800	1	P-77992	0088381708746	98,00
28	1320	1200	1	P-78003	0088381708753	183,00
30	370	250	1	P-78019	0088381708760	59,00
30	570	450	1	P-78025	0088381708777	69,00
32*	370	250	1	P-78031	0088381708784	61,00
32*	570	450	1	P-78047	0088381708791	74,00
32*	920	800	1	P-78053	0088381708807	112,00
35	370	250	1	P-78075	0088381708821	73,00
35	570	450	1	P-78081	0088381708838	84,00
35	670	550	1	P-78097	0088381708845	102,00
38	370	250	1	P-78134	0088381708883	88,00
38	570	450	1	P-78140	0088381708890	104,00
40	370	250	1	P-78156	0088381708906	104,00
40	570	450	1	P-78162	0088381708913	125,00
40	920	800	1	P-78178	0088381708920	167,00
40	1320	1200	1	P-78184	0088381708937	228,00
45	570	450	1	P-78190	0088381708944	177,00
50	570	450	1	P-78215	0088381708968	201,00

Brocas SDS-MAX

TCT - 4 cortes



Ø (mm)	Comprimento (mm)	Compr. útil (mm)	Un.	Código	EAN	P.V.P. (€)
12	340	200	1	E-11324	0088381582605	11,65
12	540	400	1	E-11330	0088381582612	16,10
14	340	200	1	E-11346	0088381582629	14,45
14	540	400	1	E-11352	0088381582636	18,35
16	340	200	1	E-11368	0088381582643	17,20
16	540	400	1	E-11374	0088381582650	21,10
18	340	200	1	E-11380	0088381582667	23,00
18	540	400	1	E-11396	0088381582674	27,00

Ø (mm)	Comprimento (mm)	Compr. útil (mm)	Un.	Código	EAN	P.V.P. (€)
20	340	220	1	E-11405	0088381582681	27,00
20	540	420	1	E-11411	0088381582698	33,00
22	340	220	1	E-11427	0088381582704	32,00
22	540	420	1	E-11433	0088381582711	37,00
24	340	220	1	E-11449	0088381582728	36,00
24	540	420	1	E-11455	0088381582735	42,00
25	340	220	1	E-11461	0088381582742	37,00
25	540	420	1	E-11477	0088381582759	43,00
28	370	250	1	E-11483	0088381582766	47,00
28	570	450	1	E-11499	0088381582773	57,00
30	370	250	1	E-11508	0088381582780	57,00
30	570	450	1	E-11514	0088381582797	70,00



Brocas SDS-MAX



4 vantagens significativas:

1. Vida mais longa da broca.
2. Maior velocidade de perfuração do que as brocas convencionais.
3. Rápida remoção do pó do furo = economia de tempo e dinheiro.
4. Menos vibrações e energia diretamente na ponta da broca = menos esforço.

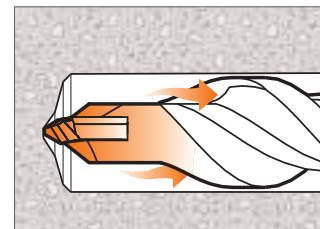

Brocas MAK2



MAK 2

Ø (mm)	Comprimento (mm)	Compr. útil (mm)	Un.	Código	EAN	P.V.P. (€)
12	340	200	1	P-17033	0088381943369	31,00
12	540	400	1	P-17049	0088381943376	39,00
12	690	550	1	P-17055	0088381943383	55,00
14	340	200	1	P-17077	0088381943406	35,00
14	540	400	1	P-17083	0088381943413	42,00
15	340	200	1	P-17108	0088381943437	35,00
15	540	400	1	P-17114	0088381943444	43,00



Brocas 2C Standard



RAPIDEZ DE PERFURAÇÃO

- Soldadura extremamente resistente entre o carboneto de tungstênio e o aço, o que torna a broca muito resistente.
- Núcleo reforçado para melhor absorção das vibrações e melhor transmissão de força para a ponta da broca.
- Espiral volumosa de duas hélices ideal para a remoção rápida do material perfurado, como em ambientes húmidos, por exemplo, perfurações em mineração ou pedra natural.

Ø (mm)	Comprimento (mm)	Compr. útil (mm)	Un.	Código	EAN	P.V.P. (€)
14	340	200	1	P-70655	0088381701235	27,00
14	540	400	1	P-70661	0088381701242	34,00
16	340	200	1	P-70677	0088381701259	32,00
16	540	400	1	P-70683	0088381701266	36,00
18	340	200	1	P-70699	0088381701273	34,00
18	540	400	1	P-70708	0088381701280	38,00
20	320	200	1	P-70714	0088381701297	35,00
20	520	400	1	P-70720	0088381701303	39,00
22	320	200	1	P-70736	0088381701310	37,00
22	520	400	1	P-70742	0088381701327	42,00
24	320	200	1	P-70758	0088381701334	41,00
24	520	400	1	P-70764	0088381701341	47,00
25	320	200	1	P-70770	0088381701358	42,00
25	520	400	1	P-70786	0088381701365	47,00

Ø (mm)	Comprimento (mm)	Compr. útil (mm)	Un.	Código	EAN	P.V.P. (€)
28	370	250	1	P-70792	0088381701372	48,00
28	570	450	1	P-70801	0088381701389	54,00
30	370	250	1	P-70817	0088381701396	48,00
30	570	450	1	P-70823	0088381701402	57,00
32	370	250	1	P-70839	0088381701419	50,00
32	570	450	1	P-70845	0088381701426	61,00
35	370	250	1	P-70851	0088381701433	60,00
35	570	450	1	P-70867	0088381701440	71,00
38	370	250	1	P-70873	0088381701457	71,00
38	570	450	1	P-70889	0088381701464	81,00
40	370	250	1	P-70895	0088381701471	84,00
40	570	450	1	P-70904	0088381701488	101,00

Brocas de coroa SDS-MAX



**BROCAS DE COROA
IDEAIS PARA PERFURAR BETÃO E ALVENARIA:**

- Alinhamento assimétrico dos dentes.
- Espiral externa que reduz o peso em 8 %.
- Redução da espessura da parede do dente e dente chanfrado na coroa para melhor penetração no material.
- Duas ranhuras assimétricas para evacuar o pó.



Brocas de coroa SDS-MAX



Ø (mm)	Comprimento (mm)	Un.	Código	EAN	P.V.P. (€)
40	100	1	P-03779	0088381917438	85,00
50	100	1	P-03785	0088381917445	89,00
65	100	1	P-03791	0088381917452	108,00
80	100	1	P-03800	0088381917469	122,00
90	100	1	P-03816	0088381917476	144,00
100	100	1	P-03822	0088381917483	166,00
125	100	1	P-16374	0088381932394	240,00



Broca centradora SDS-MAX



Ø (mm)	Comprimento (mm)	Un.	Código	EAN	P.V.P. (€)
11	120	1	P-03838	0088381917490	9,35

Adaptadores



Tipo	Comprimento (mm)	Un.	Código	EAN	P.V.P. (€)
Cónico	180	1	P-16994	0088381943321	43,00
Cónico	450	1	P-17005	0088381943338	60,00

Cunha



Un.	Código	EAN	P.V.P. (€)
1	P-03763	0088381944960	8,80

Brocas de campânula SDS-MAX



Para uso em betão, alvenaria e pedra natural.

As brocas de campânula Makita são a ferramenta moderna para os utilizadores profissionais. Uma broca de coração potente, desenvolvida para a última geração de martelos rotativos, garante uma perfuração eficiente e uma vida útil superior.

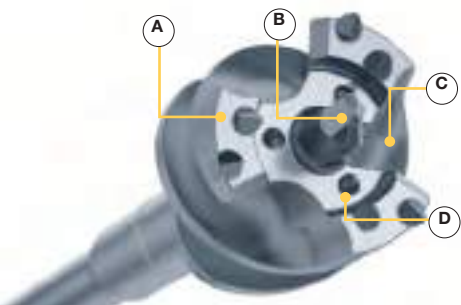

- (A) Dentes de carboneto em forma de cinzel para uma penetração rápida no betão.
- (B) Ponta central para maior precisão.
- (C) Três saídas para remover grandes quantidades de pó e detritos.
- (D) Três dentes adicionais de carboneto para demolir as pedras mais pequenas.

- **Menos vibrações.**
- **Mais leves.**
- **Tratamento térmico especial que aumenta a vida útil da broca.**
- **Construção de peça única para uma transmissão de potência perfeita.**

Ø (mm)	Comprimento (mm)	Un.	Código	EAN	P.V.P. (€)
45	550	1	B-57635	0088381519878	185,00
45	990	1	B-57641	0088381519885	218,00
55	550	1	B-57657	0088381519892	219,00
55	990	1	B-57663	0088381519908	246,00

Ø (mm)	Comprimento (mm)	Un.	Código	EAN	P.V.P. (€)
65	550	1	B-57679	0088381519915	230,00
65	990	1	B-57685	0088381519922	273,00
80	550	1	B-57691	0088381519939	254,00
80	990	1	B-57700	0088381519953	337,00

Brocas de campânula modulares

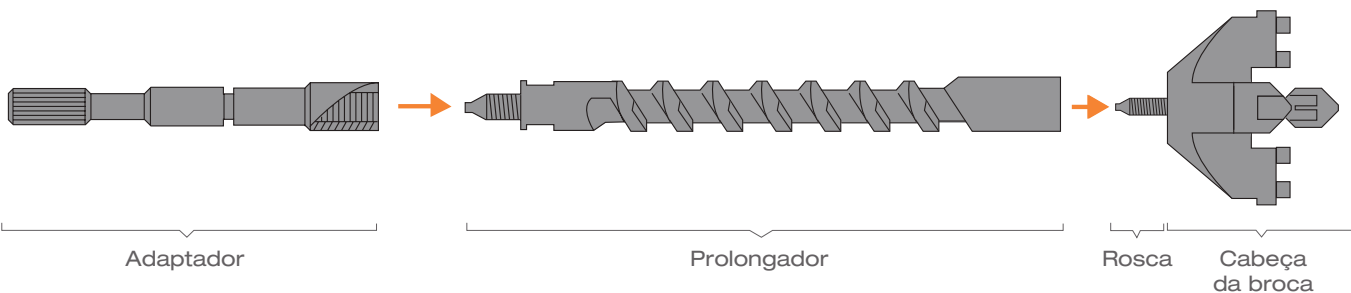

Adaptadores

Tipo	Comprimento (mm)	Un.	Código	EAN	P.V.P. (€)
SDS-MAX	195	1	P-03888	0088381917544	56,00
B	175	1	P-03894	0088381917551	47,00

Prolongador

Ø (mm)	Comprimento (mm)	Un.	Código	EAN	P.V.P. (€)
25	280	1	P-03925	0088381917582	91,00

Rosca com mola para cabeça

Ø (mm)	Comprimento (mm)	Un.	Código	EAN	P.V.P. (€)
	50	1	P-03931	0088381917599	21,00

Cabeça da broca

Ø (mm)	Comprimento (mm)	Modelo	Un.	Código	EAN	P.V.P. (€)
35	150	HR4003C HR4013C	1	P-04008	0088381945028	129,00
40	150		1	P-03844	0088381917506	136,00
50	150		1	P-03850	0088381917513	166,00
55	150		1	P-04014	0088381945035	183,00
60	150	HR4003C HR4013C HR4501C HR4511C HR5202C HR5212C	1	P-04020	0088381945042	187,00
68	150		1	P-03866	0088381917520	206,00
80	150		1	P-03872	0088381917537	262,00
90	150		1	P-04036	0088381945059	370,00



P-03931

MAK - Conexión SDS-MAX

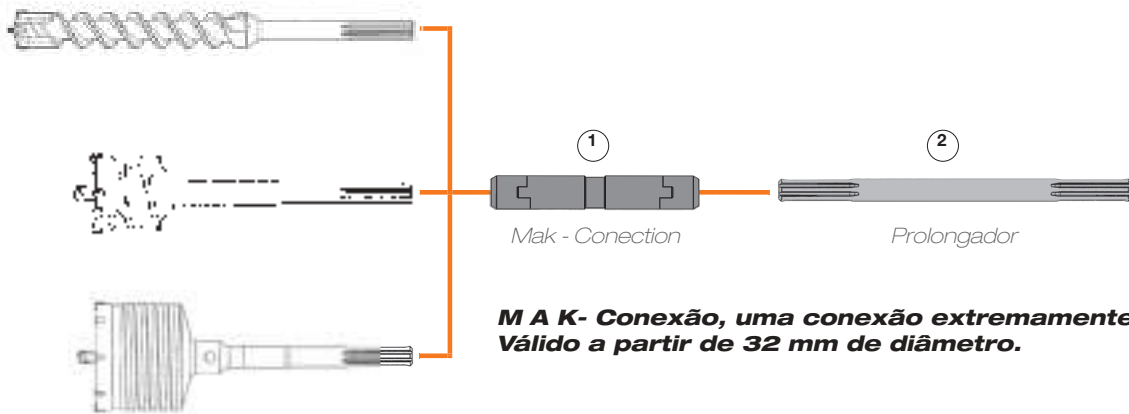

MAK- Conexão, uma conexão extremamente robusta. Válido a partir de 32 mm de diâmetro.



Sistema de conexão para brocas, MAK-Connection. Uma revolução no mundo da perfuração.

Vantagens do sistema MAK-Connection:

- O sistema SDS - MAX, MAK-Connection, permite uma conexão segura e rápida entre a broca e o adaptador.
- Sem perdas de energia, ao contrário dos sistemas existentes. A potência total é transmitida para a broca.

Adaptadores de inserção



Descrição	Comprimento (mm)	Acessório	Un.	Código	EAN	P.V.P. (€)
Mak Connection	-	SDS-MAX	1	P-53914	0088381984423	191,00
Prolongador	320		1	P-53920	0088381984430	27,00
Prolongador	750		1	P-53936	0088381984447	34,00
Prolongador	1100		1	P-53942	0088381984454	47,00

Descrição	Máquina	Acessório	Un.	Código	EAN	P.V.P. (€)
Adaptador	K	SDS-MAX	1	P-02319	0088381944953	147,00
Adaptador	SDS-MAX	SDS-PLUS	1	P-17027	0088381943352	74,00



XGT X2
80 V_{max}



**Sistemas
de aspiração
para martelos.**



XGT
40V Li-ion
max

SDS-PLUS

Ponteiros



- Para todo o tipo de trabalhos de alvenaria, betão e pedra solta.



B-64238

Largura (mm)	Comprimento (mm)	Série	Un.	Código	EAN	P.V.P. (€)
14	250	Premium ★★★★★	1	B-64238	0088381534444	11,40
14	250	Long life ★★★	1	B-64294	0088381534505	7,80
14	250	Padrão ★★	1	D-08713	0088381179522	3,80

Cinzéis



- Para todos os tipos de trabalhos de alvenaria, betão e pedra solta.



B-64244

Largura (mm)	Comprimento (mm)	Série	Un.	Código	EAN	P.V.P. (€)
20	250	Premium ★★★★★	1	B-64244	0088381534451	11,40
20	250	Long life ★★★	1	B-64303	0088381534512	7,80
20	250	Padrão ★★	1	D-08729	0088381179539	3,65

Espátulas



- Para a demolição universal de materiais de maior volume.



B-64250

Largura (mm)	Comprimento (mm)	Série	Un.	Código	EAN	P.V.P. (€)
40	250	Premium ★★★★★	1	B-64250	0088381534468	16,60
40	250	Long life ★★★	1	B-64319	0088381534529	11,45
40	250	Padrão ★★	1	D-08735	0088381179546	4,90
50	215	Padrão ★★	1	D-25616	0088381338431	5,20

Espátula para asfalto



- Para trabalhos em estradas, por exemplo, reabilitação de superfícies ou outras reparações de estradas.



P-24935

Largura (mm)	Comprimento (mm)	Série	Un.	Código	EAN	P.V.P. (€)
60	250	Long life ★★★	1	P-24935	0088381951845	17,00

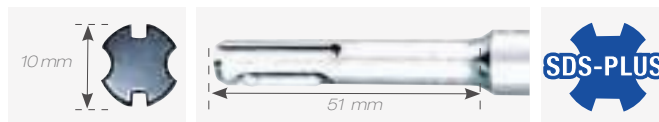

Espátula serrilhada



- Para renovar as paredes, remova a massa de vidro-cieiro das juntas.



P-25096

Largura (mm)	Comprimento (mm)	Série	Un.	Código	EAN	P.V.P. (€)
32	200	Long life ★★★	1	P-25096	0088381952002	65,00

Espátulas curvas



- Remoção fácil e simples de azulejos (com extremidade angular ergonómica).



P-24941

Largura (mm)	Comprimento (mm)	Série	Un.	Código	EAN	P.V.P. (€)
40	200	Long life	1	P-24941	0088381951852	12,99
60	250	★★★	1	P-24957	0088381951869	18,00

Escopro



- Para fazer ranhuras em alvenaria.



P-05533

Largura (mm)	Comprimento (mm)	Série	Un.	Código	EAN	P.V.P. (€)
22	250	Long life	1	P-05533	0088381921329	14,95
22	240	★★★	1	P-25080	0088381951999	13,90

Escopro nervurado com aletas



- Para o tratamento de calcário, betão, tijolos, pedrapomes, particularmente eficaz e seguro devido à sua profundidade de ranhura variável de 10-35 mm sem escorregar na ranhura.



P-24963

Largura (mm)	Comprimento (mm)	Série	Un.	Código	EAN	P.V.P. (€)
22	250	Long life ★★★	1	P-24963	0088381951876	26,00

SDS-PLUS

Formões



- Para trabalhos gerais de carpintaria, remoção rápida de material de madeira macia, por exemplo, para remoção de caixilhos de janelas antigas.



P-25111

Largura (mm)	Comprimento (mm)	Série	Un.	Código	EAN	P.V.P. (€)
20	170	Long life	1	P-25105	0088381952019	18,55
30	170	★★★	1	P-25111	0088381952026	25,00

Raspador



- Para levantar tapetes e remover adesivos de superfícies duras.



A-68161

Largura (mm)	Descriç.	Tipo	Un.	Código	EAN	P.V.P. (€)
100	Raspador	-	1	A-68161	0088381537254	80,00
-	Lâmina	Para A-68161	1	343411-9	0088381118415	29,00

Jogo de demolição



Conteúdo	Un.	Código	EAN	P.V.P. (€)
Ponteiro 14 x 250 mm	1	D-05181	0088381177450	24,00
Cinzel 20 x 250 mm	1			
Espátula 40 x 250 mm	1			

Jogo de demolição



Conteúdo	Un.	Código	EAN	P.V.P. (€)
Ponteiro 14 x 250 mm	2	D-16368	0088381187848	35,00
Cinzel 20 x 250 mm	2			
Espátula 40 x 250 mm	1			



Jogo de demolição



Conteúdo	Un.	Código	EAN	P.V.P. (€)
Ponteiro 250 mm	1	D-42357	0088381404815	30,00
Cinzel 20 x 250 mm	1			
Espátula 40 x 250 mm	1			

SDS-MAX

Ponteiros



- Para todo o tipo de trabalhos de alvenaria, betão e pedra solta.



B-10366

Largura (mm)	Comprimento (mm)	Série	Un.	Código	EAN	P.V.P. (€)
18	280	Long life ★★★	1	P-16237	0088381932264	8,00
18	400		1	P-16243	0088381932271	11,85
18	600		1	P-16259	0088381932288	15,70
18	300	Padrão ★★	1	D-34176	0088381364836	5,80
18	400		1	D-34182	0088381364843	7,25
18	400		10	D-34182-10	0088381367240	66,00
18	600		1	D-34198	0088381364850	9,30
18	400	Autoafiável ★★★★	1	B-10366	0088381342469	12,35
18	400	Autoafiável espiral ★★★★	1	B-23064	0088381406161	19,05

Cinzéis



- Para todos os tipos de trabalhos de alvenaria, betão e pedra solta.



P-16265

Largura (mm)	Comprimento (mm)	Série	Un.	Código	EAN	P.V.P. (€)
25	280	Long life ★★★	1	P-16265	0088381932295	8,00
25	400		1	P-16271	0088381932301	11,85
25	600		1	P-16287	0088381932318	15,70
25	300	Padrão ★★	1	D-34207	0088381364867	5,80
25	400		1	D-34213	0088381364874	7,55
25	400		10	D-34213-10	0088381367257	71,00
25	600		1	D-34229	0088381364881	9,00

Conjunto de cinzéis e espátulas 5 + 5



Largura (mm)	Comprimento (mm)	Série	Un.	Código	EAN	P.V.P. (€)
18	400	Padrão ★★	5	D-35324-10	0088381367905	53,00
25	400		5			



Espátulas



- Para a demolição em material de maior volume.



P-16302

Largura (mm)	Comprimento (mm)	Série	Un.	Código	EAN	P.V.P. (€)
50	350	Long life ★★★	1	P-16302	0088381932332	15,95
80	300		1	P-16318	0088381932349	24,00
50	400	Padrão ★★	1	D-34235	0088381364898	8,25
80	300		1	D-34241	0088381364904	13,35

Espátula curva



- Remoção fácil e simples de azulejos. Com extremidade angular ergonómica.



P-16324

Largura (mm)	Comprimento (mm)	Série	Un.	Código	EAN	P.V.P. (€)
50	300	Long life ★★★	1	P-16324	0088381932356	24,00

Espátula serrilhada



- Para renovar as paredes, por exemplo, para remover a massa de vidraceiro das juntas.



P-16346

Largura (mm)	Comprimento (mm)	Série	Un.	Código	EAN	P.V.P. (€)
38	280	Long life ★★★	1	P-16346	0088381932370	62,00

Escopro



- Para fazer ranhuras em alvenaria.



P-16293

Largura (mm)	Comprimento (mm)	Série	Un.	Código	EAN	P.V.P. (€)
26	300	Long life ★★★	1	P-16293	0088381932325	25,00

SDS-MAX

Escopro nervurado com aletas



- Para ranhurar em calcário, betão, tijolos, pedrapomes, particularmente eficaz e seguro devido à sua profundidade variável de ranhuras de 10-35 mm sem escorregar para o interior do sulco.



Largura (mm)	Comprimento (mm)	Série	Un.	Código	EAN	P.V.P. (€)
35	380	Long life ★★★	1	P-16330	0088381932363	49,00

Pá



- Perfeita para cavar a terra.



Largura (mm)	Comprimento (mm)	Série	Un.	Código	EAN	P.V.P. (€)
110	400	Long life ★★★	1	P-23721	0088381950664	49,00

Compactador



- Para a compactação de materiais macios.



Adaptador

Compactador

Ø (mm)	Descrição	Série	Un.	Código	EAN	P.V.P. (€)
140	Compactador	Long life	1	A-19875	0088381158985	83,00
-	Adaptador compactador	★★★	1	A-19897	0088381159005	40,00

Bujarda



- Para bujardar zonas de pedra ou de betão.



Adaptador

Base

Medida (mm)	Descrição	Série	Un.	Código	EAN	P.V.P. (€)
60 x 60	Base	Long life	1	P-03947	0088381932820	77,00
250	Adaptador	★★★	1	P-16352	0088381932387	28,00

Adaptador para placa de ligação à terra

- Para cravar as placas na terra.



502024

Ø (mm)	Comprimento (mm)	Série	Un.	Código	EAN	P.V.P. (€)
13	260	Long life ★★★	1	502024	-	36,00
16	260		1	P-63797	0088381994316	41,00
19	260		1	502026	-	46,00
22,2	260		1	E-13041	0088381590211	57,00

Estojos SDS-MAX



Conteúdo	Série	Un.	Código	EAN	P.V.P. (€)
Ponteiros	Padrão ★★	2	D-40565	0088381403405	62,00
Cinzéis		2			
Espátulas		2			



Conteúdo	Série	Un.	Código	EAN	P.V.P. (€)
Ponteiro	Padrão ★★	1	D-42450	0088381404914	46,00
Cinzel		1			
Espátula		1			

Makita Hexagonal 17 mm

- Para os modelos **HM0810T e HM0830T**

Ponteiros



- Para todo o tipo de trabalhos de alvenaria, betão e pedra solta.



D-08682

Largura (mm)	Comprimento (mm)	Série	Un.	Código	EAN	P.V.P. (€)
17	280	Padrão ★★	1	D-08682	0088381182911	3,35
17	450		1	D-16863	0088381192897	9,30
17	450	Long life ★★★	1	P-13041	0088381932844	21,00

Espátulas



- Para a demolição em material de maior volume.



P-13079

Largura (mm)	Comprimento (mm)	Série	Un.	Código	EAN	P.V.P. (€)
50	280	Padrão ★★	1	D-20694	0088381277709	5,20
45	280	Long life ★★★	1	P-13079	0088381932875	20,15

Escopro nervurado com aletas



- Para ranhurar em calcário, betão, tijolos, pedra-pomes, particularmente eficaz e seguro devido à sua profundidade variável de ranhuras de 10-35 mm sem escorregar para o interior do sulco.



P-13100

Largura (mm)	Comprimento (mm)	Série	Un.	Código	EAN	P.V.P. (€)
35	380	Long life ★★★	1	P-13100	0088381932905	37,00



Cinzéis



- Para todo o tipo de trabalhos de alvenaria, betão e pedra solta.



D-08707

Largura (mm)	Comprimento (mm)	Série	Un.	Código	EAN	P.V.P. (€)
19	280	Padrão ★★	1	D-08707	0088381182935	5,55
19	450		1	D-16879	0088381192880	6,10
24	280	Long life ★★★	1	P-13057	0088381932851	14,95
24	450		1	P-13063	0088381932868	17,40

Escopro curvo



- Para fazer ranhuras em alvenaria.



P-67393

Largura (mm)	Comprimento (mm)	Série	Un.	Código	EAN	P.V.P. (€)
26	280	Long life ★★★	1	P-67393	0088381997928	31,00



B Hexagonal 19 mm

- Para os modelos **HR3520B, HR3850B, HR5000 e *HM1200B.**

Ponteiros



- Para todo o tipo de trabalhos de alvenaria, betão e pedra solta.



D-20074

Largura (mm)	Comprimento (mm)	Série	Un.	Código	EAN	P.V.P. (€)
19	300	Padrão	1	D-20074	0088381256087	8,40
19	450	★★	1	D-19196	0088381253918	9,50
19	300	Long life	1	P-13122	0088381932912	15,30
19	450	★★★	1	P-13138	0088381932929	19,65

- Para o modelo **HM1200B**



Ø (mm)	Comprimento (mm)	Série	Un.	Código	EAN	P.V.P. (€)
19	400	Long life	1	P-05620	0088381921411	15,45
19	600	★★★	1	P-05614	0088381921404	20,10

Cinzéis



- Para todo o tipo de trabalhos de alvenaria, betão e pedra solta.



P-13144

Largura (mm)	Comprimento (mm)	Série	Un.	Código	EAN	P.V.P. (€)
24	300	Long life	1	P-13144	0088381932936	15,65
24	450	★★★	1	P-13150	0088381932943	18,50

- Para o modelo **HM1200B.**



Largura (mm)	Comprimento (mm)	Série	Un.	Código	EAN	P.V.P. (€)
25	400	Long life	1	P-05636	0088381921428	14,60
25	600	★★★	1	P-05642	0088381921435	19,60

Pá



- Para o modelo **HM1200B.**



P-05670

Largura (mm)	Comprimento (mm)	Série	Un.	Código	EAN	P.V.P. (€)
105	400	Long life	1	P-05670	0088381921466	63,00

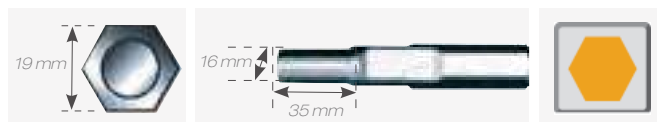

Escopro curvo



- Para fazer ranhuras em alvenaria.



P-13188

Largura (mm)	Comprimento (mm)	Série	Un.	Código	EAN	P.V.P. (€)
22	250	Long life	1	P-13188	0088381932974	23,00

- Para o modelo **HM1200B**



Largura (mm)	Comprimento (mm)	Série	Un.	Código	EAN	P.V.P. (€)
22	300	Long life	1	P-05658	0088381921442	23,00

Escopro nervurado com aletas



- Para ranhurar em calcário, betão, tijolos, pedrapomes, particularmente eficaz e seguro devido à sua profundidade variável de ranhuras de 10-35 mm sem escorregar para o interior do sulco.



P-13219

Largura (mm)	Comprimento (mm)	Série	Un.	Código	EAN	P.V.P. (€)
35	380	Long life	1	P-13219	0088381932998	54,00

Espátulas



- Para a demolição em material de maior volume.



P-13166

Largura (mm)	Comprimento (mm)	Série	Un.	Código	EAN	P.V.P. (€)
50	300	Long life	1	P-13166	0088381932950	27,00

- Para o modelo **HM1200B.**



Largura (mm)	Comprimento (mm)	Série	Un.	Código	EAN	P.V.P. (€)
60	300	Long life	1	P-05664	0088381921459	29,00
60	450	★★★	1	P-05686	0088381921473	37,00

Makita Hexagonal 21 mm

- Para o modelo HM1200.

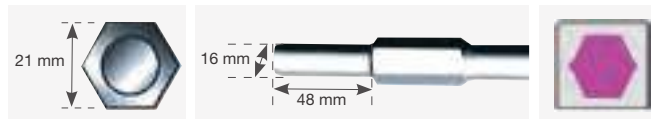

Ponteiros

- Para todo o tipo de trabalhos de alvenaria, betão e pedra solta.



P-13378

Largura (mm)	Comprimento (mm)	Série	Un.	Código	EAN	P.V.P. (€)
21	450	Padrão ★★	1	D-23824	0088381312912	9,00
21	320	Long life ★★★	1	P-13378	0088381112468	17,80
21	450		1	P-13384	0088381943116	23,00
21	600		1	P-13390	0088381104432	24,00

Cinzéis

- Para todo o tipo de trabalhos de alvenaria, betão e pedra solta.



P-13409

Largura (mm)	Comprimento (mm)	Série	Un.	Código	EAN	P.V.P. (€)
24	320	Long life ★★★	1	P-13409	0088381943147	18,60
24	450		1	P-13415	0088381943154	24,00

Espátulas

- Para a demolição em material de maior volume.



P-13437

Largura (mm)	Comprimento (mm)	Série	Un.	Código	EAN	P.V.P. (€)
70	320	Long life ★★★	1	P-13437	0088381943178	39,00

Pá



798035-0

Largura (mm)	Comprimento (mm)	Série	Un.	Código	EAN	P.V.P. (€)
120	450	Long life ★★★	1	798035-0	0088381103558	92,00



Makita Hexagonal 30 mm

- Para os modelos **HM1317C**, **HM1307C** e ***HM1400**.

Ponteiros



- Para todo o tipo de trabalhos de alvenaria, betão e pedra solta.



D-15285

Largura (mm)	Comprimento (mm)	Série	Un.	Código	EAN	P.V.P. (€)
30	410	Padrão ★★	1	D-15285	0088381186377	16,55
30	400	Long life ★★★	1	P-05549	0088381921336	31,00
30	400		1	B-10388*	0088381342483	34,00
30	700		1	P-05561	0088381921350	45,00

*autoafiável

Espátulas



- Para a demolição em material de maior volume.



D-23868

Largura (mm)	Comprimento (mm)	Série	Un.	Código	EAN	P.V.P. (€)
75	310	Padrão ★★	1	D-23868	0088381313094	21,75
75	310		1	D-34805	0088381365802	21,75
115	400	Long life ★★★	1	P-13518	0088381943239	73,00

- Para o modelo **HM1400**.

Largura (mm)	Comprimento (mm)	Série	Un.	Código	EAN	P.V.P. (€)
110	400	Long life ★★★	1	P-13493	0088381943215	61,00

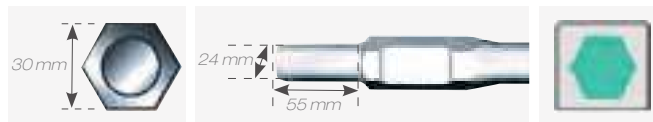

Cinzéis



- Para todo o tipo de trabalhos de alvenaria, betão e pedra solta.



D-15300

Largura (mm)	Comprimento (mm)	Série	Un.	Código	EAN	P.V.P. (€)
30	400	Padrão ★★	1	D-15300	0088381186384	17,15
32	410	Long life ★★★	1	P-13487	0088381943208	30,00

- Para o modelo **HM1400**

Largura (mm)	Comprimento (mm)	Série	Un.	Código	EAN	P.V.P. (€)
32	400	Long life ★★★	1	P-13502	0088381943222	31,00
32	700		1	P-05583	0088381921374	44,00

Compactador



A-31485

Ø (mm)	Série	Un.	Código	EAN	P.V.P. (€)
200	Long life ★★★	1	A-31485	0088381151610	115,00

Pá



A-31485

Largura (mm)	Comprimento (mm)	Tipo	Un.	Código	EAN	P.V.P. (€)
125	400	Long life ★★★	1	P-05555	0088381921343	76,00
120	500	Padrão ★★	1	B-10300	0088381341288	99,00

- Para o modelo **HM1400**

Largura (mm)	Comprimento (mm)	Série	Un.	Código	EAN	P.V.P. (€)
125	400	Long life ★★★	1	P-05608	0088381921398	58,00

Makita Hexagonal 28,6 mm

- Para os modelos **HM1317CB, HM1304B, HM1801, HM1810 e HM1812.**



Ponteiros



- Para todo o tipo de trabalhos de alvenaria, betão e pedra solta.



P-05692

Largura (mm)	Comprimento (mm)	Série	Un.	Código	EAN	P.V.P. (€)
28,6	400	Long life	1	P-05692	0088381921480	28,00
28,6	600	★★★	1	P-64272	0088381994798	47,00
28,6	400	Premium ★★★★★	1	B-10372*	0088381342476	31,00

*autoafável



D-17631

Largura (mm)	Comprimento (mm)	Série	Un.	Código	EAN	P.V.P. (€)
28,6	400	Long life	1	D-17631	0088381197182	18,90
28,6	600	★★★	1	P-65931	0088381996464	36,00

Cinzéis



- Para todo o tipo de trabalhos de alvenaria, betão e pedra solta.

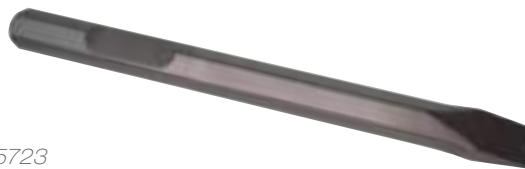

P-05723

Largura (mm)	Comprimento (mm)	Série	Un.	Código	EAN	P.V.P. (€)
35	400	Long life	1	P-05723	0088381921510	27,00
30	600	★★★	1	P-64288	0088381994804	47,00



P-65947

Largura (mm)	Comprimento (mm)	Série	Un.	Código	EAN	P.V.P. (€)
28	410	Padrão ★★	1	D-17647	0088381197199	18,90
30	600	Long life ★★★★★	1	P-65947	0088381996471	36,00

Espátulas



- Para a demolição em material de maior volume.



D-29228

Largura (mm)	Comprimento (mm)	Série	Un.	Código	EAN	P.V.P. (€)
75	410	Padrão ★★	1	D-29228	0088381345682	20,05
80	400	Long life ★★★★★	1	P-05701	0088381921497	49,00

Compactador



798385-3

Ø (mm)	Série	Un.	Código	EAN	P.V.P. (€)
200	Long life ★★★★★	1	798385-3	0088381127554	203,00

Pá



P-05717

Largura (mm)	Comprimento (mm)	Série	Un.	Código	EAN	P.V.P. (€)
125	400	Long life ★★★★★	1	P-05717	0088381921503	70,00



K Hexagonal 21 mm

- Para os modelos K.



Ponteiros



- Para todo o tipo de trabalhos de alvenaria, betão e pedra solta.

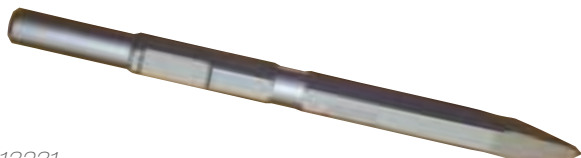

P-13231

Largura (mm)	Comprimento (mm)	Série	Un.	Código	EAN	P.V.P. (€)
21	300	Long life ★★★	1	P-13231	0088381933001	18,05
21	460		1	P-13253	0088381943024	23,00
21	600		1	P-13269	0088381943031	25,00

Espátulas



- Para a demolição em material de maior volume.



P-13312

Largura (mm)	Comprimento (mm)	Série	Un.	Código	EAN	P.V.P. (€)
75	300	Long life ★★★	1	P-13312	0088381943086	31,00

Pá



A-07157

Largura (mm)	Comprimento (mm)	Série	Un.	Código	EAN	P.V.P. (€)
120	500	Long life ★★★	1	A-07157	0088381111980	93,00

Cinzéis



- Para todo o tipo de trabalhos de alvenaria, betão e pedra solta.



P-13275

Largura (mm)	Comprimento (mm)	Série	Un.	Código	EAN	P.V.P. (€)
25	300	Long life ★★★	1	P-13275	0088381126717	18,05
25	460		1	P-13297	0088381943062	21,00
25	600		1	P-13306	0088381943079	27,00

Escopro nervurado com aletas



- Para ranhar em calcário, betão, tijolos, pedrapomes, particularmente eficaz e seguro devido à sua profundidade variável de ranhuras de 10-35 mm sem escorregar para o interior do sulco.

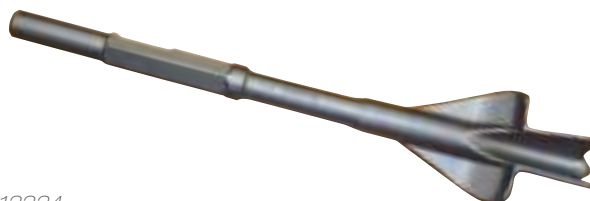

P-13334

Largura (mm)	Comprimento (mm)	Série	Un.	Código	EAN	P.V.P. (€)
35	380	Long life ★★★	1	P-13334	0088381943109	54,00



Makita Hexagonal 19 mm

- Para o modelo HK1810

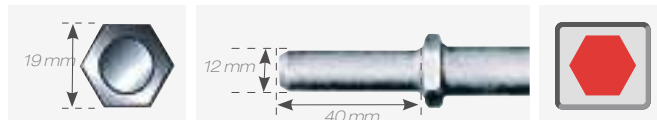

Ponteiro



- Para todo o tipo de trabalhos de alvenaria, betão e pedra solta.



Largura (mm)	Comprimento (mm)	Série	Un.	Código	EAN	P.V.P. (€)
19	220	Long life ★★★	1	B-06921	0088381313292	13,40

Cinzel



- Para todo o tipo de trabalhos de alvenaria, betão e pedra solta.



Largura (mm)	Comprimento (mm)	Série	Un.	Código	EAN	P.V.P. (€)
20	220	Long life ★★★	1	B-07004	0088381313308	16,75

Cinzéis curvos



- Remoção fácil e simples de azulejos (com extremidade angular ergonómica).



Largura (mm)	Comprimento (mm)	Série	Un.	Código	EAN	P.V.P. (€)
35	190	Long life ★★★	1	P-05496	0088381921282	64,00
50	190		1	P-05474	0088381921268	25,00

Espátula



- Para a demolição em material de maior volume.



Largura (mm)	Comprimento (mm)	Série	Un.	Código	EAN	P.V.P. (€)
50	220	Long life ★★★	1	B-07010	0088381313315	19,05

Raspador



Largura (mm)	Tipo	Un.	Código	EAN	P.V.P. (€)
100	Raspador completo	1	122431-4	0088381114882	62,00
100	Só lâmina	1	343411-9	0088381118415	29,00

Escopro



Largura (mm)	Série	Un.	Código	EAN	P.V.P. (€)
45	Long life ★★★	1	P-05480	0088381921275	28,00



Conjunto eixo - mandril SDS-MAX 



Descrição	Rosca	Inserção	Un.	Código	EAN	P.V.P. (€)
Conjunto	1/2"	SDS-MAX	1	122829-5	0088381435901	61,00

Porta-brocas e porta-ferramentas para martelos leves



Porta-brocas automático



Porta-ferramenta SDS-PLUS



Descrição	mm	Modelos	Un.	Código	EAN	P.V.P. (€)
Porta-brocas	13	DHR243 DHR263 HR002G HR2630T HR2631FT HR2810T HR2811FT	1	194079-2	0088381196826	60,00
	13	DHR281 DHR283	1	199139-5	0088381525695	51,00
	13	HR3210FCT	1	194568-7	0088381347389	69,00
	13	HR3012	1	191F46-4	0088381560795	51,00
Porta-ferramentas SDS-PLUS	-	DHR243 DHR263 HR002G HR2630T HR2631FT HR2810T HR2811FT	1	194080-7	0088381196833	31,00
	-	DHR281 DHR283	1	199138-7	0088381525718	22,00
	-	HR3210FCT	1	125420-8	3240890170774	55,00
	-	HR3012	1	191F47-2	0088381560801	32,00

Carrinho de transporte



Modelos	Un.	Código	EAN	P.V.P. (€)
HM1812	1	D-54972	0088381450904	134,00

Conjunto eixo - mandril SDS-PLUS 



P-18150



D-14093

com porta-brocas

Descrição	Rosca	Inserção	Un.	Código	EAN	P.V.P. (€)
Conjunto	1/2"	SDS-PLUS	1	P-18150	0088381944472	44,00
Adaptador	1/2"	SDS-PLUS	1	D-14093	0088381359450	2,60

Soprador de pó



Un.	Código	EAN	P.V.P. (€)
1	765009-6	0088381102377	2,30

Óleo grafitado



Conteúdo (g)	Un.	Código	EAN	P.V.P. (€)
30	1	P-08361	0088381913072	3,10

Pano de limpeza



Un.	Código	EAN	P.V.P. (€)
1	443122-7	0088381205658	3,05

Lubrificante para broca



198993-4



183477-5

Conteúdo (g)	Un.	Código	EAN	P.V.P. (€)
30	1	183477-5	0088381373760	3,85
100	1	198993-4	0088381518994	6,20

Sistemas de proteção contra o pó

A Makita cuida da saúde e do conforto de trabalho dos nossos utilizadores todos os dias, e um dos maiores perigos é a inalação de pó mineral.



A longo prazo, pode causar graves problemas respiratórios, por isso é essencial agir sobre este problema.

Para isso, a Makita desenvolveu uma gama completa de acessórios de aspiração para conexão à maioria dos nossos martelos leves.

O pó não é algo que se possa varrer para debaixo do tapete, é algo perigoso que pode afetar a sua saúde. **Tome medidas!**



Coletores de pó aspiração automática



Tipo	Modelos	Medidas (mm)	Un.	Código	EAN	P.V.P. (€)
DX01	DHR242	372 x 88 x 287	1	195898-9	0088381400589	114,00
DX02	DHR243	397 x 88 x 287	1	195902-4	0088381400626	114,00
DX05	DHR182	431 x 82 x 285	1	199664-6	0088381540315	91,00
DX08	DHR280 DHR282	435 x 86 x 306	1	199581-0	0088381540827	145,00
DX09	DHR281 DHR283	457 x 86 x 306	1	199585-2	0088381540865	145,00
DX10	HR3011FC	592 x 145 x 242	1	191F95-1	0088381565752	113,00
DX11	HR3012FC	661 x 145 x 242	1	191G00-4	0088381565806	113,00
DX12	HR001G HR003G	425 x 86 x 306	1	191E54-9	0088381560047	160,00



Filtro para DX01, DX02, DX03, DX05, DX08, DX09 e DX12



Válido	Descrição	Un.	Código	EAN	P.V.P. (€)
DX01 DX02 DX08 DX09 DX12	Filtro HEPA	1	199557-7	0088381539784	11,00
DX03	Jogo alojamento de filtro	1	196162-1	0088381413220	30,00
DX05	Filtro HEPA	1	199596-7	0088381541466	8,75
DX10 DX11	Jogo caixa coletor de pó	1	191F49-8	0088381560818	49,00



Coletores de pó para martelos leves



Modelos	Un.	Código	EAN	P.V.P. (€)
HR2651T	1	136017-8	0088381585910	89,00
HR2650	1	136018-6	0088381548502	95,00



Extrator de pó



Modelos	Un.	Código	EAN	P.V.P. (€)
HR2230 HR2460 HR2470	1	193472-7	0088381174022	46,00

Coletor de pó SDS-PLUS



Modelos	Un.	Código	EAN	P.V.P. (€)
DHR171 DHR182 DHR202 DHR263 HR140D HR166D HR1830 HR1841F HR2230 HR2470 HR2800 HR2810 HR2811	1	198362-9*	0088381483636	15,60

* Usar com adaptador.

Adaptadores para uso com coletor de pó. 198362-9

Modelos	Un.	Código	EAN	P.V.P. (€)
DHR165 DHR171 DHR182 HR1830 HR140D HR166D HR1841F	1	194581-5	0088381371599	13,40
DHR202 DHR263 HR2810T HR2811FT	1	194582-3	0088381367219	5,10
HR2230 HR2460 HR2470	1	194583-1	0088381367226	4,80
HR3011 HR3012	1	191L91-5	0088381567411	5,60

Saco de pó



Modelos	Un.	Código	EAN	P.V.P. (€)
HR2430	1	193976-9	0088381191333	13,40
HR2432	1	122708-7	0088381202992	8,45

Tampas para o pó



Tipo 1

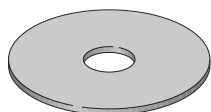

Indicado para	Tipo	Un.	Código	EAN	P.V.P. (€)
Brocas 6 a 14 mm. Ø	1	1	421342-3	0088381116602	2,30
Brocas 12 a 16 mm. Ø	1	1	421664-1	0088381149754	3,60
HK1810	2	1	423154-0	0088381123846	0,75

Coletor de pó SDS-PLUS



Podemos conectar dois coletores para aspirar quando trabalhamos com brocas mais longas.

Modelos	Un.	Código	EAN	P.V.P. (€)
DHR242 DHR280 DHR282 HR2630 HR2600 HR2300	1	195173-3	0088381361125	7,05
DHR243 DHR281 DHR283 HR2611FT HR2630T	1	195179-1	0088381361194	8,40

Adaptador 1/2" para SDS-MAX
(para remover brocas presas)



* Utilizar com chaves de impacto de 1/2".

Tipo	Un.	Código	EAN	P.V.P. (€)
1/2"	1	195870-1	0088381398336	103,00

Coletores de pó para martelos combinados



Kit

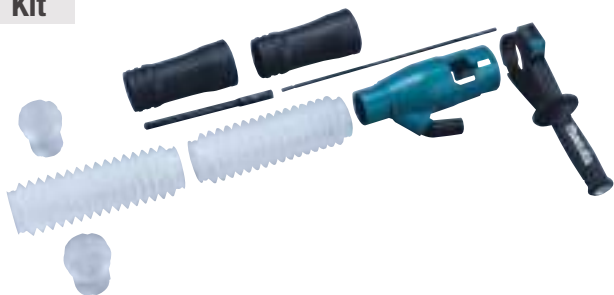

Modelos	Un.	Código	EAN	P.V.P. (€)
HR4001C HR4011C HR4501C HR4511C	1	196074-8	0088381407632	105,00
HR5212C	1	196858-4	0088381441599	77,00
DHR400 HR4003C HR4013C	1	199142-6	0088381524339	100,00

Coletores de pó para martelos demolidores



Modelos	Un.	Código	EAN	P.V.P. (€)
HM1307C HM1317C HM1400 HM1812	1	197168-2	0088381449984	53,00
HM1501	1	191M20-4	0088381575713	61,00

Punhos

Tipo 1



* Só punho.

Modelos	Un.	Código	EAN	P.V.P. (€)
HR2800 HR2230 HR2460 HR2470 HR2810 HR2811	1	158057-6	3240890278531	4,55
HR2510	1	273496-0	3240890119971	11,35
HR3000C HM0860C HM0830T	1	152554-4	0088381156318	8,50
HR3520B HR3850B HR5000K	1	273472-4	0088381115841	10,30
HR4000C HR4001C HR4011C	1	134803-1	0088381144384	28,00
HR4501C HR4511C HR5201C HR5211C	1	158131-0	0088381346115	10,30
HM0810T HR3850B HR3520B	1	273457-0	0088381123440	10,80

Tipo 2



Modelos	Un.	Código	EAN	P.V.P. (€)
HR3520B HR3850B HR5000 HR5000K	1	134887-9	0088381151474	37,00
HR4000C HR4001C HR4011C HR4501C HR4511C HM1111C HM1101C HR3540C HR3541FC	1	134890-0	0088381152266	34,00
HR4500C	1	134915-0	0088381160087	28,00
HR5001C	1	134945-1	0088381164979	28,00
HR5201C HR5211C HM1202C HM1203C HM1213C	1	135269-8	0088381359528	39,00
HM1200K	1	134944-3	0088381200998	22,00
HM0860C HM0830T HM0870C HM0871C HM1100C HM1200 HM1200B	1	134909-5	0088381164962	26,00
HM1214C HR5202C HR5212C	1	135283-4	0088381359771	38,00
HR4003C	1	196792-8	0088381568678	25,00

Tipo 3



* Punho completo

Modelos	Un.	Código	EAN	P.V.P. (€)
HR2020 HR2440 HR2450 HR2432	1	135302-6	0088381364430	3,70
HR2300 HR2600 HR2610 HR2610T HR2611FT	1	122878-2	0088381401463	13,10
HR3000C	1	134889-5	0088381152297	20,10
HR3200C HR3210C/FCT	1	135197-7	0088381349710	20,10
HR3540C HR3541FC HR4001C HR4011C HR4501C HR4511C	1	135209-6	0088381361828	21,00
HR4500C	1	134916-8	0088381160094	23,00
HR5001C	1	134881-1	0088381152921	26,00
HR5201C HR5211C	1	135380-6	0088381366243	23,00
HM001G HM0870C HM0871C	1	135332-7	0088381367196	22,00

Tipo 1



Tipo 2



Tipo 3



Furar

- Metal
- Madeira
- Alvenaria
- Vidro

Escarear Bater



Ezychange



Brocas de coroa Unicut para alvenaria e azulejo

Broca da coroa



Ø (mm)	Comprimento (mm)	Modelos	Un.	Código	EAN	P.V.P. (€)
25	60	HR2300 HR2600 HR2610 HR2610T HR2611FT HR2630 HR2630T HR2631	1	P-64462	0088381994989	29,00
30	60		1	P-64478	0088381994996	29,00
35	60		1	P-64484	0088381995009	33,00
40	60		1	P-64490	0088381995016	34,00
45	60		1	P-64509	0088381995023	35,00
50	60		1	P-64515	0088381995030	36,00
55	60		1	P-64521	0088381995047	38,00
58	60		1	P-64537	0088381995054	42,00
60	60		1	P-64543	0088381995061	42,00
63	60		1	P-64559	0088381995078	42,00
65	60		1	P-64565	0088381995085	43,00
68	60		1	P-64571	0088381995092	46,00
70	60		1	P-64587	0088381995108	52,00
71	60		1	P-64593	0088381995115	53,00
74	60		1	P-64602	0088381995122	54,00
76	60	HR2800 HR2810 HR2810T HR2811FT HR3011 HR3012 HR3200C HR3210C HR3210FCT	1	P-64618	0088381995139	55,00
80	60		1	P-64630	0088381995153	57,00
85	60		1	P-64646	0088381995160	62,00
90	60		1	P-64652	0088381995177	64,00
105	60		1	P-64668	0088381995184	83,00

Adaptador para brocas UNICut



Ø (mm)	Comprimento (mm)	Un.	Código	EAN	P.V.P. (€)
M16	118	1	P-64319	0088381994835	28,00
M16	370	1	P-64331	0088381994859	34,00

Broca centradora para brocas Unicut



Ø (mm)	Comprimento (mm)	Ponta	Un.	Código	EAN	P.V.P. (€)
8	120	TCT	1	P-64347	0088381994866	6,25

UNICut



As brocas UNICut são projetadas para utilização numa ampla gama de materiais:

- Alvenaria, tijolos, azulejos, etc.
- Materiais leves como gesso cartonado, tabique, Fermacell, etc.
- Em plástico, madeira prensada, contraplacado, etc.

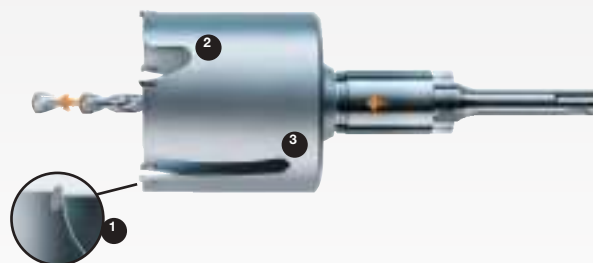

UNICut - vantagens convincentes!

1 Robusta e duradoura: Os dentes de carboneto, com uma superfície mais ampla, soldados (1) de forma segura, asseguram e garantem que os dentes não se soltarão da broca.

Rápida progressão ao furar: graças à estrutura robusta e ao corte agressivo.

2 Otimizando a vida do corpo: A vibração foi melhorada graças à geometria especial das câmaras de evacuação ampliadas (2) e da ranhura de extração de gases (3).



Brocas para tijolo

★★



Ø (mm)	Comprimento (mm)	Un.	Código	EAN	P.V.P. (€)
3	60	1	D-05228	0088381176453	1,15
4	70	1	D-05234	0088381176460	1,15
5	85	1	D-05240	0088381176477	1,15
6	100	1	D-05256	0088381176484	1,15
6	150	1	D-05262	0088381176491	1,15
7	100	1	D-05278	0088381176507	1,15
7	150	1	D-05284	0088381176514	1,15
8	110	1	D-05290	0088381176521	1,15
8	150	1	D-05309	0088381176538	1,15
9	150	1	D-05315	0088381176545	1,15
10	150	1	D-05321	0088381176552	1,45
11	150	1	D-05337	0088381176569	1,45
12	150	1	D-05343	0088381176576	2,00
13	150	1	D-05359	0088381176583	2,60
14	150	1	D-05365	0088381176590	2,60
15	150	1	D-05371	0088381176606	2,60
16	150	1	D-05387	0088381176613	2,90

Brocas para tijolo TCT

★★★



Ø (mm)	Comprimento (mm)	Un.	Código	EAN	P.V.P. (€)
3	60	1	E-06351	0088381569309	1,40
4	70	1	E-06367	0088381569316	1,40
5	85	1	E-06373	0088381569323	1,40
5	150	1	E-06389	0088381569330	1,40
6	100	1	E-06410	0088381569361	1,40
6	150	1	E-06426	0088381569378	1,40
8	110	1	E-06482	0088381569439	1,40
8	150	1	E-06498	0088381569446	1,40
10	150	1	E-06529	0088381569477	1,40
10	250	1	E-06535	0088381569484	2,85
12	150	1	E-06541	0088381569491	2,25
12	250	1	E-06557	0088381569507	3,10
14	150	1	E-06563	0088381569514	2,85
14	250	1	E-06579	0088381569521	3,95
16	150	1	E-06585	0088381569538	3,15
18	200	1	E-06591	0088381569545	4,55
20	200	1	E-06600	0088381569552	5,10

Brocas para tijolo 1/4" hexagonal

★★



Ø (mm)	Comprimento (mm)	Un.	Código	EAN	P.V.P. (€)
5	90	1	D-23793	0088381312882	1,95
6	100	1	D-23802	0088381312899	2,00
8	100	1	D-23818	0088381312905	2,70

Brocas ponta de seta 1/4" hexagonal

★★★



Ø (mm)	Comprimento (mm)	Un.	Código	EAN	P.V.P. (€)
4	65	1	D-15942	0088381187107	2,60
5	65	1	D-15958	0088381187114	2,60
6	65	1	D-15964	0088381187121	2,85
8	70	1	D-15970	0088381187138	2,85
10	80	1	D-15986	0088381187145	3,50



Makita

Brocas multimaterial

Omn|Bohrer

★★



Ø (mm)	Comprimento (mm)	Comprimento útil (mm)	Un.	Código	EAN	P.V.P. (€)
3	60	26	1	D-30287	0088381353151	0,85
4	70	36	1	D-30293	0088381353168	0,85
5	85	41	1	D-30302	0088381353175	0,85
5,5	100	56	1	D-31033	0088381355056	0,85
6	150	101	1	D-30324	0088381353199	0,90
6	250	170	1	D-72780	0088381577298	1,70
6,5	100	56	1	D-31061	0088381355087	0,90
7	150	101	1	D-30346	0088381353212	1,15
8	150	95	1	D-30368	0088381353236	1,15
9	150	95	1	D-30374	0088381353243	1,40
10	150	95	1	D-30380	0088381353250	1,45
12	150	91	1	D-30411	0088381353281	2,00
12	400	298	1	D-30427	0088381353298	4,30
13	150	83	1	D-30449	0088381353342	2,30
14	150	83	1	D-30455	0088381353311	2,60
14	400	298	1	D-30461	0088381353328	5,75

Brocas multimaterial

Omn|Bohrer

★★★



Ø (mm)	Comprimento (mm)	Comprimento útil (mm)	Un.	Código	EAN	P.V.P. (€)
3	70	38	1	E-10958	0088381581615	1,50
4	75	40	1	E-10964	0088381581622	1,50
5	85	43	1	E-10970	-	1,60
5,5	100	50	1	E-10986	0088381581646	1,75
6	150	90	1	E-11003	0088381581660	2,05
6,5	150	90	1	E-11025	0088381581684	2,20
7	100	50	1	E-11031	0088381581691	2,05
8	150	90	1	E-11053	0088381581714	2,75
10	150	90	1	E-11069	0088381581721	3,25
12	150	90	1	E-11075	0088381581738	3,65
13	150	90	1	E-11081	0088381581745	4,50



Brocas padrão para madeira

★★★

- Com ponta centralizadora.



Ø (mm)	Comprimento (mm)	Comprimento útil (mm)	Un.	Código	EAN	P.V.P. (€)
3	60	33	1	D-07026	0088381178587	0,90
4	75	43	1	D-07032	0088381178594	0,90
5	85	52	1	D-07048	0088381178600	0,90
6	95	57	1	D-07054	0088381178617	0,85
6	315	160	1	D-07157	0088381178716	3,05
7	110	69	1	D-07060	0088381178624	1,15
8	115	75	1	D-07076	0088381178631	1,15
8	315	160	1	D-07163	0088381178723	3,40
9	125	81	1	D-07082	0088381178648	1,45
10	135	87	1	D-07098	0088381178655	1,45
10	315	160	1	D-07179	0088381178730	4,10
12	155	101	1	D-07107	0088381178662	2,05
12	315	160	1	D-07185	0088381178747	4,95
13	151	96	1	D-53453	0088381449373	2,65
14	170	108	1	D-07113	0088381178679	2,60
14	315	160	1	D-07191	0088381178754	5,85
15	160	100	1	D-53469	0088381449380	3,25
16	180	105	1	D-07129	0088381178686	4,10
16	315	160	1	D-07200	0088381178761	7,00
18	200	120	1	D-07135	0088381178693	5,85
18	335	160	1	D-07216	0088381178778	9,40
20	200	130	1	D-07141	0088381178709	6,45
20	335	160	1	D-07222	0088381178785	11,75

Brocas helicoidais para madeira

★★★

- Ideal para furos passantes.
- Ótima extração de aparas.
- Ponta autorroscante.



Ø (mm)	Comprimento (mm)	Comprimento útil (mm)	Un.	Código	EAN	P.V.P. (€)
6	250	180	1	D-07331	0088381178891	3,25
8	250	180	1	D-07347	0088381178907	3,40
8	450	380	1	D-07559	0088381179119	7,10
10	250	180	1	D-07353	0088381178914	5,20
10	450	380	1	D-07565	0088381179126	7,65
12	250	180	1	D-07369	0088381178921	5,70
12	450	380	1	D-07571	0088381179133	8,75
13	250	180	1	D-53475	0088381449397	6,00
13	450	380	1	D-53497	0088381449410	9,55
14	250	180	1	D-07375	0088381178938	6,55
14	450	380	1	D-07587	0088381179140	9,55
15	250	180	1	D-53481	0088381449403	6,55
15	450	380	1	D-53506	0088381449427	10,65
16	250	180	1	D-07381	0088381178945	6,80
16	450	380	1	D-07593	0088381179157	11,15
18	250	180	1	D-07397	0088381178952	7,65
18	450	380	1	D-07602	0088381179164	12,50
20	250	180	1	D-07406	0088381178969	7,90
20	450	380	1	D-07618	0088381179171	14,30
22	250	180	1	D-07412	0088381178976	8,45
22	450	380	1	D-07624	0088381179188	15,80
24	250	180	1	D-07428	0088381178983	9,00
24	450	380	1	D-07630	0088381179195	17,70
26	450	380	1	D-07646	0088381179201	20,15
28	450	380	1	D-07652	0088381179218	23,00
30	450	380	1	D-07668	0088381179225	27,00

Brocas padrão para madeira 1/4" hexagonal

★★★



Ø (mm)	Comprimento (mm)	Comprimento útil (mm)	Un.	Código	EAN	P.V.P. (€)
3	75	33	1	D-15861	0088381187022	1,15
4	90	43	1	D-15877	0088381187039	1,15
5	100	52	1	D-15883	0088381187046	1,45
6	110	57	1	D-15899	0088381187053	1,45
8	115	75	1	D-15908	0088381187060	2,05
10	130	87	1	D-15914	0088381187077	2,35
12	150	101	1	D-15920	0088381187084	3,20
15	160	108	1	D-15936	0088381187091	5,00

Brocas helicoidais para madeira 1/4" hexagonal

★★★



Ø (mm)	Comprimento (mm)	Comprimento útil (mm)	Un.	Código	EAN	P.V.P. (€)
6	200	130	1	D-15992	0088381187152	4,05
8	200	130	1	D-16003	0088381187169	4,60
10	200	130	1	D-16019	0088381187176	5,45
12	200	130	1	D-16025	0088381187183	5,75
14	200	130	1	D-16031	0088381187190	5,70
16	200	130	1	D-16047	0088381187206	5,85
18	200	130	1	D-16053	0088381187213	6,55
20	200	130	1	D-16069	0088381187220	7,60
21	200	130	1	D-16075	0088381187237	9,50

Brocas de pala para madeira ★★

- Com ponta centralizadora.
- Alta velocidade de perfuração.



Ø (mm)	Comprimento (mm)	Un.	Código	EAN	P.V.P. (€)
6	150	1	D-07674	0088381179232	1,45
8	150	1	D-07680	0088381179249	1,45
10	150	1	D-07696	0088381179256	1,45
12	150	1	D-07705	0088381179263	1,75
13	150	1	D-67614	0088381549363	1,75
14	150	1	D-07711	0088381179270	1,75
15	150	1	D-07727	0088381179287	1,75
16	150	1	D-07733	0088381179294	1,75
18	150	1	D-07749	0088381179300	2,05
20	150	1	D-07755	0088381179317	2,05
22	150	1	D-07761	0088381179324	2,05
24	150	1	D-07777	0088381179331	2,65
25	150	1	D-07783	0088381179348	2,65
26	150	1	D-07799	0088381179355	2,65
28	160	1	D-07808	0088381179362	2,90
30	160	1	D-07814	0088381179379	3,20
32	160	1	D-07820	0088381179386	3,55
34	160	1	D-07836	0088381179393	3,80
35	160	1	D-07842	0088381179409	3,80
36	160	1	D-07858	0088381179416	4,10



Brocas de precisão Forstner para madeira ★★

- Perfurações perfeitas, com menos rebarbas.
- Menos ruído.
- Menos esforço.
- Fornecidas em recipiente de plástico com um gancho para pendurar.
- O desenho dos dentes oferece alta precisão e alto desempenho.
- Ponta centralizadora para um início preciso da perfuração.
- Medição marcada na broca para fácil reconhecimento.
- Pode ser usada em berbequins com porta-brocas de 10 mm e 13 mm.



Ø (mm)	Comprimento (mm)	Un.	Código	EAN	P.V.P. (€)
10	90	1	D-41844	0088381404648	6,15
15	90	1	D-41925	0088381404686	7,25
20	90	1	D-42232	0088381404693	8,35
25	90	1	D-42248	0088381404709	8,95
26	90	1	D-42254	0088381404716	9,50
30	90	1	D-42260	0088381404723	10,00
32	90	1	D-42276	0088381404730	10,60
35	90	1	D-42282	0088381404747	11,15
40	90	1	D-42298	0088381404754	12,85
50	90	1	D-42307	0088381404761	17,55



Brocas autoalimentadas para madeira

- A ponta do parafuso roscado empurra a broca em direção à peça de trabalho, proporcionando uma autoalimentação rápida e fácil de usar.
- Para fazer furos de grande diâmetro de forma limpa.
- Dispõem de um parafuso de alimentação central.
- Rosca helicoidal.
- As esporas de contorno definem com precisão o diâmetro do furo.

★★



D-74304



D-74407

Ø (mm)	Comprimento (mm)	Un.	Código	EAN	P.V.P. (€)
25	127	1	D-74304	0088381587341	11,85
28	127	1	D-74310	0088381587358	13,90
32	127	1	D-74326	0088381587365	15,45
35	127	1	D-74332	0088381587372	16,50
38	127	1	D-74348	0088381587389	18,55
45	127	1	D-74354	0088381587396	22,00
51	127	1	D-74360	0088381587402	24,00
54	127	1	D-74376	0088381587419	27,00
57	127	1	D-74382	0088381587426	32,00
65	127	1	D-74398	0088381587433	36,00
76	127	1	D-74407	0088381587440	54,00
92	127	1	D-74413	0088381587457	63,00
117	127	1	D-74429	0088381587464	80,00

Pontas para brocas autoalimentadas

★★



Ø (mm)	Un.	Código	EAN	P.V.P. (€)
25 - 65	1	D-74435	0088381587471	1,30
76 - 117	1	D-74441	0088381587488	1,30

Extensões para brocas autoalimentadas

★★



Comprimento (mm)	Un.	Código	EAN	P.V.P. (€)
140	1	D-74457	0088381587495	10,30
305	1	D-74463	0088381587501	12,35
457	1	D-74479	0088381587518	14,95



Brocas cilíndricas para metal

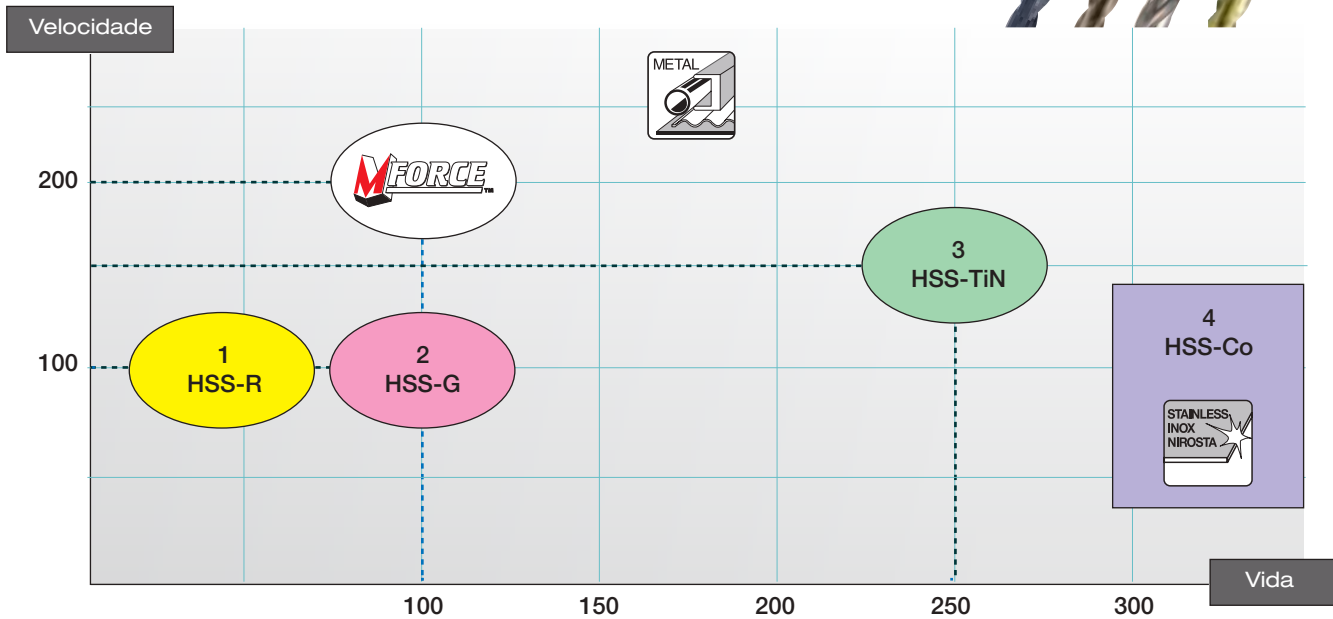
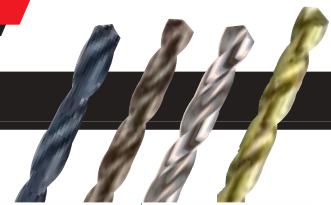

Descrição	A	B	C	D	E	
						Material
1	HSS-R	HSS	Laminada	118°	Preto	Cilíndrica
2	HSS-G	HSS	Retificada	118°	Brilhante	Cilíndrica
3	HSS-TiN	HSS	Retificada	135°	Titânio	Cilíndrica ou 1/4" hex.
4	HSS-Co	HSS-Co 5 %	Retificada	135°	Cobalto	Cilíndrica
5	M-FORCE	HSS - M-FORCE	Retificada	M-FORCE	Titânio	Cilíndrica 3 faces

Descrição	Material	Material						
		Madeira	Plástico	Metais não ferrosos	Chapa de aço	Ferro fundido	Aço	Aço inoxidável
1	HSS-R Broca de metal	◆	✓		◆	✓		
2	HSS-G Broca de metal	◆	✓	✓	✓	✓	✓	◆
3	HSS-TiN	◆	✓	✓	✓	✓	✓	◆
4	HSS-Co			◆	◆	✓	✓	✓
5	M-FORCE	◆	✓	✓	✓	✓	✓	◆

✓ : Recomendado ◆ : Válido



Brocas cilíndricas para metal

A Fabricada com...



Aço de corte rápido



Aço de corte rápido com 5 % de cobalto adicionado.

Para uma maior resistência à abrasão e ao calor. Ideal para perfuração de metais duros.

B Tipo

HSS-R

Laminadas



Fabricada em metal fundido. É o processo mais económico. Bisel nas bordas da espiral para uma melhor evacuação da aparas.

HSS-G

Retificadas



Tanto a espiral como a borda são fabricadas a partir do mesmo bloco de metal, o que confere à broca uma qualidade superior. Espiral chanfrada para um corte mais rápido e eficaz.

C Geometria da ponta

HSS-R e HSS-G

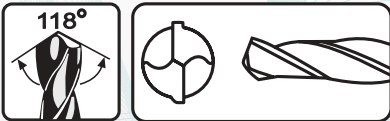

HSS-TIN e HSS-Co

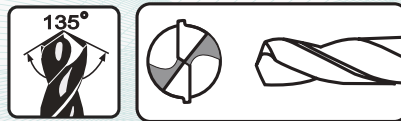

M-FORCE



O ângulo de 135° facilita o início da perfuração e evita que a broca escorregue.

Brocas com um ponto de autocentralização em forma de M que evita o seu deslocamento para uma perfuração mais precisa.

D Acabamento

Acabamento preto

Acabamento brilhante

Acabamento em titânio

Acabamento em cobalto



Duram até 150 % mais do que outras brocas.

Alta qualidade com 5 % de cobalto

E Inserção

Reta (cilíndrica)

Hexagonal 1/4"

Cilíndrica (3 faces)



Pode ser usada com um porta-brocas de 1/4". Simplifica a trocas de brocas.

Três eixos planos na haste. Evita o deslizamento da broca

Brocas para metal HSS-R DIN338



- Brocas indicadas para furar aço com resistência máxima de 900 N/mm², ferro fundido, plásticos e metais não ferrosos.
- Risco mínimo de rutura para diâmetros pequenos graças à possibilidade de flexão do material.
- Espiral com duas saídas para uma evacuação eficaz do material em excesso.
- Brocas para corte em metal com um ângulo na ponta de 118°.
- Bisel nas bordas da espiral para uma melhor evacuação da apara.

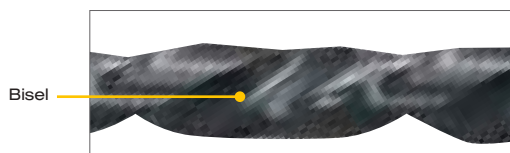

- Blister com duas unidades nas brocas com medidas compreendidas entre 1,5 - 4,0 mm.
- Brocas standard com uma relação qualidade-preço muito boa.

Ø (mm)	Comprimento (mm)	Comprimento útil (mm)	Un.	Código	EAN	P.V.P. (€)
1,5	40	18	2	D-38299	0088381398787	1,15
2,0	49	24	2	D-38308	0088381398794	1,15
2,5	57	30	2	D-38314	0088381398800	1,10
3,0	61	33	2	D-38336	0088381398824	1,15
3,5	70	39	2	D-38358	0088381398848	1,15
4,0	75	43	2	D-38364	0088381398855	1,15
4,5	80	47	1	D-38386	0088381398879	0,85
5,0	86	52	1	D-38401	0088381398893	0,85
5,5	93	57	1	D-38417	0088381398909	0,85
6,0	93	57	1	D-38423	0088381398916	0,85
6,5	101	63	1	D-38439	0088381398923	1,15
7,0	109	69	1	D-38445	0088381398930	1,15
7,5	109	69	1	D-38451	0088381398947	1,15
8,0	117	75	1	D-38467	0088381398954	1,40
8,5	117	75	1	D-38473	0088381398961	1,40
9,0	125	81	1	D-38489	0088381398978	1,70
10,0	133	87	1	D-38495	0088381398985	2,00
11,0	142	94	1	D-38504	0088381398992	2,55
12,0	151	101	1	D-38510	0088381399005	3,10
13,0	151	101	1	D-38526	0088381399012	3,40

Brocas para metal HSS-G DIN338



- Brocas indicadas para furar aço com resistência máxima de 900 N/mm², metais fundidos, plásticos duros e metais não ferrosos.
- Oferece uma perfuração mais rápida e uma vida útil superior.
- Espiral com duas saídas para uma evacuação eficaz do material em excesso.
- Fabrico em aço de excelente qualidade.
- Brocas para corte em metal com um ângulo na ponta de 135°.
- Espiral chanfrada para um corte mais rápido e eficaz.
- Brocas de boa qualidade para aplicações profissionais.

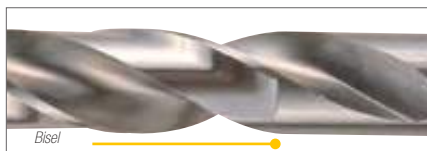

Ø (mm)	Comprimento (mm)	Comprimento útil (mm)	Un.	Código	EAN	P.V.P. (€)
1,5	40	18	1	D-09656	0088381184922	0,85
2,0	49	24	1	D-09662	0088381184939	0,80
2,5	57	30	1	D-09678	0088381184946	0,85
3,0	61	33	1	D-09684	0088381184953	0,85
3,5	70	39	1	D-09690	0088381184960	1,10
4,0	75	43	1	D-09709	0088381184977	1,10
4,5	80	47	1	D-09715	0088381184984	1,20
5,0	86	52	1	D-09721	0088381184991	1,45
5,5	93	57	1	D-09737	0088381185004	1,65
6,0	93	57	1	D-09743	0088381185011	1,75
6,5	101	63	1	D-09759	0088381185028	1,90
7,0	109	69	1	D-09765	0088381185035	2,25
7,5	109	69	1	D-09771	0088381185042	2,50
8,0	117	75	1	D-09787	0088381185059	3,25
8,5	117	75	1	D-09793	0088381185066	3,00
9,0	125	81	1	D-09802	0088381185073	3,55
9,5	125	81	1	D-09818	0088381185080	3,80
10,0	133	87	1	D-09824	0088381185097	4,35
10,5	133	87	1	D-09830	0088381185103	5,70
11,0	142	94	1	D-09846	0088381185110	6,00
11,5	142	94	1	D-09852	0088381185127	6,55
12,0	151	101	1	D-09868	0088381185134	7,10
12,5	151	101	1	D-09874	0088381185141	7,60
13,0	151	101	1	D-09880	0088381185158	8,20

Brocas para metal HSS-TIN DIN338



- Brocas indicadas para furar aço com resistência máxima de 900 N/mm², metais fundidos, plásticos duros e metais não ferrosos.
- Brocas revestidas em nitrato de titânio para reduzir o atrito e prolongar a vida útil da broca.
- Brocas 40 % mais rápidas do que a nossa gama HSS-G.
- Duração 150% superior em relação à nossa gama HSS-G.
- Brocas para corte em metal com um ângulo na ponta de 135°, o que favorece a entrada no material e atinge uma maior velocidade de perfuração.
- Espiral chanfrada para um corte mais rápido e eficaz.
- Brocas de grande qualidade para aplicações profissionais que requerem maior velocidade.

Ø (mm)	Comprimento (mm)	Comprimento útil (mm)	Un.	Código	EAN	P.V.P. (€)
1,5	40	18	2	D-42961	0088381405447	3,10
2	49	24	2	D-42977	0088381405454	3,10
2,5	57	30	2	D-42983	0088381405461	3,10
3	61	33	2	D-43000	0088381405485	3,10
3,5	70	39	2	D-43038	0088381405515	3,10
4	75	43	2	D-43044	0088381405522	3,10
4,5	80	47	1	D-43072	0088381405553	2,05
5	86	52	1	D-43094	0088381405577	2,30
5,5	93	57	1	D-43119	0088381405591	2,60
6	93	57	1	D-43125	0088381405607	2,85
6,5	101	63	1	D-43131	0088381405614	3,10
7	109	69	1	D-43147	0088381405621	3,10
7,5	109	69	1	D-43153	0088381405638	3,60
8	117	75	1	D-43169	0088381405645	5,40
8,5	117	75	1	D-43175	0088381405652	5,40
9	125	81	1	D-43181	0088381405669	6,70
9,5	125	81	1	D-43197	0088381405676	6,95
10	133	87	1	D-43206	0088381405683	7,20
10,5	133	87	1	D-45375	0088381407717	10,30
11	142	94	1	D-43212	0088381405690	10,30
11,5	142	94	1	D-45381	0088381407724	10,30
12	151	101	1	D-43228	0088381405706	13,40
12,5	151	101	1	D-45397	0088381407731	15,20
13	151	101	1	D-43234	0088381405713	15,95

Brocas para metal HSS-TIN 1/4" hexagonal



- Brocas indicadas para furar aço com resistência máxima de 1000 N/mm², aços tratados, aços inoxidáveis e metais fundidos.
- Brocas de alta durabilidade, indicadas para trabalhos de precisão.
- Ideais para trabalhos em suportes para berbequins.
- Fabricadas em metal de alta qualidade com 5 % de cobalto adicionado.
- Brocas para corte em metais com um ângulo na ponta de 118°, que reduz o risco de deslocamento da broca durante a perfuração.
- Estas brocas são perfeitas para os trabalhos mais exigentes:
 - Aço inoxidável.
 - Trabalhos em todo o tipo de carroçarias de automóveis.
 - Cordões de soldadura.

Ø (mm)	Comprimento (mm)	Comprimento útil (mm)	Un.	Código	EAN	P.V.P. (€)
3,0	81	33	1	D-14928	0088381185967	1,65
3,2	85	36	1	D-14934	0088381185974	1,90
4,0	95	43	1	D-14940	0088381185981	1,90
5,0	106	52	1	D-14962	0088381186001	2,20
6,0	113	57	1	D-14978	0088381186018	3,00
6,5	121	63	1	D-17778	0088381200622	4,10
8,0	117	75	1	D-15827	0088381186988	5,70
10,0	133	87	1	D-15833	0088381186995	8,70
12,0	151	101	1	D-15849	0088381187008	11,45
13,0	151	101	1	D-15855	0088381187015	14,70

Broca rebitadora HSS



Ø (mm)	Comprimento (mm)	Comprimento útil (mm)	Un.	Código	EAN	P.V.P. (€)
3,3	50	20	10	B-56437	0088381490283	12,00

Brocas para metal HSS-CO DIN338 ★★★★★

- Brocas para furar aço com resistência máxima de 1000 N/mm², aços tratados, aços inoxidáveis e metais fundidos.
- Alta durabilidade, indicadas para trabalhos de precisão. Ideais para trabalhos em suportes para berbequins.
- Fabricadas em metal de alta qualidade com 5 % de cobalto adicionado.



Ø (mm)	Comprimento (mm)	Comprimento útil (mm)	Un.	Código	EAN	P.V.P. (€)
1,5	40	18	1	D-17289	0088381195942	1,35
2,0	49	24	1	D-17295	0088381195959	1,35
2,5	57	30	1	D-17304	0088381195966	1,40
3,0	61	33	1	D-17310	0088381195973	1,45
3,5	70	39	1	D-17332	0088381195997	1,45
4,0	75	43	1	D-17348	0088381196000	1,65
4,5	80	47	1	D-17354	0088381196017	1,90
5,0	86	52	1	D-17360	0088381196024	1,95
5,5	93	57	1	D-17376	0088381196031	2,45
6,0	93	57	1	D-17382	0088381196048	2,55
6,5	101	63	1	D-17398	0088381196055	3,00
7,0	109	69	1	D-17407	0088381196062	3,45
7,5	109	69	1	D-17413	0088381196079	4,65
8,0	117	75	1	D-17429	0088381196086	5,70
8,5	117	75	1	D-17435	0088381196093	6,00
9,0	125	81	1	D-17441	0088381196109	6,00
9,5	125	81	1	D-17457	0088381196116	8,05
10,0	133	87	1	D-17463	0088381196123	9,05
10,5	133	87	1	D-17479	0088381196130	10,10
11,0	142	94	1	D-17485	0088381196147	10,35
11,5	142	94	1	D-17491	0088381196154	12,95
12,0	151	101	1	D-17500	0088381196161	13,10
12,5	151	101	1	D-17516	0088381196178	15,55
13,0	151	101	1	D-17522	0088381196185	16,65

Brocas metal para SDS-PLUS ★★★★★



Ø (mm)	Comprimento (mm)	Comprimento útil (mm)	Un.	Código	EAN	P.V.P. (€)
3	90	33	1	B-57401	0088381519014	3,25
3,5	100	39	1	B-57417	0088381519021	3,25
4	105	43	1	B-57423	0088381519038	3,80
4,5	110	47	1	B-57439	0088381519045	3,85
5	116	52	1	B-57445	0088381519052	4,65
5,5	123	5	1	B-57451	0088381519069	4,65
6	123	57	1	B-57467	0088381519076	4,65
6,5	131	63	1	B-57473	0088381519083	5,20

Brocas madeira para SDS-PLUS ★★★



Ø (mm)	Comprimento (mm)	Comprimento útil (mm)	Un.	Código	EAN	P.V.P. (€)
4	105	43	1	B-57489	0088381519090	3,50
5	116	52	1	B-57495	0088381519106	3,55
6	123	57	1	B-57504	0088381519113	3,50
8	147	75	1	B-57510	0088381519120	4,10
10	163	87	1	B-57526	0088381519137	4,40

Estojo brocas madeira metal SDS-PLUS



Descrição	Un.	Código	EAN	P.V.P. (€)
Jogo de brocas SDS-PLUS madeira e metal	1	B-57532	0088381519144	13,80

Brocas cónicas

A Tipo



Broca cónica reta

B Superfície



Acabamento brilhante

Revestimento de titânio. Duram até 2,5 vezes mais do que outras brocas.

C Inserção



Inserção reta
Melhor fixação do que a inserção cilíndrica.



Ø (mm)	Flauta	Tipo	Un.	Código	EAN	P.V.P. (€)
3-14	Reta	HSS	1	D-40048	0088381400244	17,85
4-20	Reta	HSS	1	D-40054	0088381400251	27,00
16-30,5	Reta	HSS	1	D-40060	0088381400268	50,00
24-40	Reta	HSS	1	D-40076	0088381400275	90,00

Brocas cónicas escalonadas



Ø (mm)	Flauta	Tipo	Un.	Código	EAN	P.V.P. (€)
4-32	Reta	HSS	1	D-40107	0088381400305	68,00
4-32	Reta	HSS-TIN	1	D-40135	0088381400336	78,00
4-32	Espiral	HSS	1	D-40163	0088381400367	73,00
4-32	Espiral	HSS-TIN	1	D-40191	0088381400398	89,00

★★★★

★★★★★

★★★★

★★★★★

Brocas para berbequim magnético HB500 e HB350

- Espiral para uma boa evacuação de rebarbas. Ponta centralizadora que ajuda na extração do material após a perfuração.
- Inserção universal de 19 mm.

















Ø (mm)	Comprimento (mm)	Comprimento útil (mm)	Un.	Código	EAN	P.V.P. (€)
12	30	19	1	12S	-	22,00
12	50	19	1	12L	-	30,00
13	30	19	1	13S	-	22,00
13	50	19	1	13L	-	31,00
14	30	19	1	14S	-	22,00
14	50	19	1	14L	-	32,00
15	30	19	1	15S	-	23,00
15	50	19	1	15L	-	33,00
16	30	19	1	16S	-	24,00
16	50	19	1	16L	-	34,00
17	30	19	1	17S	-	24,00
17	50	19	1	17L	-	35,00
18	30	19	1	18S	-	24,00
18	50	19	1	18L	-	37,00
19	30	19	1	19S	-	25,00
19	50	19	1	19L	-	39,00
20	30	19	1	20S	-	27,00
20	50	19	1	20L	-	41,00
21	30	19	1	21S	-	28,00
21	50	19	1	21L	-	44,00
22	30	19	1	22S	-	29,00
22	50	19	1	22L	-	44,00
23	30	19	1	23S	-	30,00
23	50	19	1	23L	-	46,00
24	30	19	1	24S	-	31,00
24	50	19	1	24L	-	48,00
25	30	19	1	25S	-	35,00
25	50	19	1	25L	-	50,00
26	30	19	1	26S	-	36,00
26	50	19	1	26L	-	53,00
27	30	19	1	27S	-	37,00
27	50	19	1	27L	-	56,00
28	30	19	1	28S	-	42,00
28	50	19	1	28L	-	57,00
29	30	19	1	29S	-	43,00
29	50	19	1	29L	-	60,00
30	30	19	1	30S	-	44,00
30	50	19	1	30L	-	63,00
31	30	19	1	31S	-	45,00
31	50	19	1	31L	-	65,00

Ø (mm)	Comprimento (mm)	Comprimento útil (mm)	Un.	Código	EAN	P.V.P. (€)
32	30	19	1	32S	-	46,00
32	50	19	1	32L	-	68,00
33	30	19	1	33S	-	47,00
33	50	19	1	33L	-	73,00
34	30	19	1	34S	-	49,00
34	50	19	1	34L	-	74,00
35	30	19	1	35S	-	53,00
35	50	19	1	35L	-	77,00
36	30	19	1	36S	-	52,00
36	50	19	1	36L	-	80,00
37	30	19	1	37S	-	54,00
37	50	19	1	37L	-	83,00
38	30	19	1	38S	-	58,00
38	50	19	1	38L	-	84,00
39	30	19	1	39S	-	59,00
39	50	19	1	39L	-	93,00
40	30	19	1	40S	-	67,00
40	50	19	1	40L	-	98,00
41	30	19	1	41S	-	68,00
41	50	19	1	41L	-	102,00
42	30	19	1	42S	-	69,00
42	50	19	1	42L	-	104,00
43	30	19	1	43S	-	71,00
43	50	19	1	43L	-	107,00
44	30	19	1	44S	-	73,00
44	50	19	1	44L	-	111,00
45	30	19	1	45S	-	74,00
45	50	19	1	45L	-	124,00
46	30	19	1	46S	-	82,00
46	50	19	1	46L	-	128,00
47	30	19	1	47S	-	84,00
47	50	19	1	47L	-	136,00
48	30	19	1	48S	-	85,00
48	50	19	1	48L	-	141,00
49	30	19	1	49S	-	88,00
49	50	19	1	49L	-	143,00
50	30	19	1	50S	-	90,00
50	50	19	1	50L	-	145,00
Broca centralizadora de 30 mm				PILOTS	-	7,20
Broca centralizadora de 50 mm				PILOTL	-	9,00

Escareadores multimaterial

✓ : Recomendado

Descrição	A	B	C	Material					
	Fabricado com	Tipo	Inserção	Madeira	Plástico	Metais não ferrosos	Ferro fundido	Aço	Aço inoxidável
7 fios 	 Aço		1/4" Hex	✓	✓	✓	✓		
3 fios 	 HSS		1/4" Hex (Forma-C)	✓	✓	✓	✓	✓	
5 fios 	 HSS		Inserção cilíndrica	✓	✓	✓	✓	✓	
3 fios 	 HSS		Inserção cilíndrica	✓	✓	✓	✓	✓	
	 HSS-Co		Inserção cilíndrica		✓	✓	✓	✓	✓

A **Fabricado em Aço**

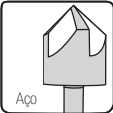



Aço de corte rápido com 5 % de cobalto. Proporciona maior dureza e resistência à abrasão. Ideal para metais duros.



B **Tipo**

Escareador cônico superficial



Escareador cônico superficial Adequado para lâminas finas.



Escareador cônico com haste longa. Perfeito para escareamentos de difícil acesso.



C **Inserção Cilíndrica**



1/4" Hexagonal



Escareadores multimaterial

- Gama de escareadores multimaterial, adequados para metal, metais não ferrosos e também para madeira. O escareamento é um processo intermédio entre a perfuração e o aparafusamento. É utilizado para o desenvolvimento de montagens através da incorporação da cabeça do parafuso utilizado no material perfurado.
- Uma vez perfurado o material, seleciona-se o escareador mais adequado para o parafuso a aparafusar.
- Uma vez realizado o escareamento, podemos preceder ao aparafusamento até que a cabeça do parafuso esteja completamente alinhada com a superfície do material.
- Outro dos trabalhos que podemos realizar com os escareadores é limpar a rebarba interna que permanece num tubo após o corte.

Escareador cónico de aço com haste 1/4" hexagonal

Metal, metais não ferrosos e madeira.



★★

Ø (mm)	Escarea-mento	Comprimento (mm)	Fios	Tipo	Un.	Código	EAN	P.V.P. (€)
13	90°	50	7	Aço	1	D-37306	0088381376105	4,60

Escareador cónico de HSS com haste 1/4" hexagonal.

Metal, metais não ferrosos e madeira.



★★★

Ø (mm)	Escarea-mento	Comprimento (mm)	Fios	Tipo	Un.	Código	EAN	P.V.P. (€)
6,3	M3	31	3	HSS	1	D-37312	0088381376112	6,00
8,3	M4	31	3	HSS	1	D-37328	0088381376129	7,10
10,4	M5	34	3	HSS	1	D-37334	0088381376136	8,20
12,4	M6	35	3	HSS	1	D-37340	0088381376143	8,70
16,5	M8	40	3	HSS	1	D-37356	0088381376150	13,10
20,5	M10	41	3	HSS	1	D-37362	0088381376167	15,80

Escareador cónico de HSS com haste cilíndrica de 6 mm.

Metal, metais não ferrosos e madeira.



★★★

Ø (mm)	Escarea-mento	Comprimento (mm)	Fios	Tipo	Un.	Código	EAN	P.V.P. (€)
6	M3	48	5	HSS	1	D-37378	0088381376174	5,95
8	M4	48	5	HSS	1	D-37384	0088381376181	6,55
10	M5	40	5	HSS	1	D-37390	0088381376198	8,15
12	M6	40	5	HSS	1	D-37409	0088381376204	9,25
16	M8	43	5	HSS	1	D-37415	0088381376211	10,90
20	M10	45	5	HSS	1	D-37421	0088381376228	14,70

Escareador cónico de HSS com haste cilíndrica de 5-6-8-10 mm.

Metal, metais não ferrosos e madeira.



★★★

Ø (mm)	Escarea-mento	Comprimento (mm)	Fios	Tipo	Un.	Código	EAN	P.V.P. (€)
6,3	M3	45	3	HSS	1	D-37437	0088381376235	6,00
8,3	M4	50	3	HSS	1	D-37443	0088381376242	7,60
10,4	M5	50	3	HSS	1	D-37459	0088381376259	8,75
12,4	M6	56	3	HSS	1	D-37465	0088381376266	9,30
16,5	M8	60	3	HSS	1	D-37471	0088381376273	12,50
20,5	M10	63	3	HSS	1	D-37487	0088381376280	16,35
25	M12	67	3	HSS	1	D-37493	0088381376297	20,15

Escareador com orifício oblíquo HSS-Co 5% com haste cilíndrica de 6-8-10-12 mm.



★★★★

Ø (mm)	Escarea-mento	Comprimento (mm)	Fios	Tipo	Un.	Código	EAN	P.V.P. (€)
2-5	90°	45	Orifício	HSS-Co	1	D-37502	0088381376303	10,90
5-10	90°	48	Orifício	HSS-Co	1	D-37518	0088381376310	17,85
10-15	90°	65	Orifício	HSS-Co	1	D-37524	0088381376327	27,00
15-20	90°	85	Orifício	HSS-Co	1	D-37530	0088381376334	48,00

Estojo de brocas para metal HSS-Co



★★★★★

Ø (mm)	Conteúdo	Un.	Código	EAN	P.V.P. (€)
de 1 a 10 mm	19 peças	1	D-67561	0088381549196	58,00

Estojo de brocas M-para metal M-Force



★★★★★

Ø (mm)	Conteúdo	Un.	Código	EAN	P.V.P. (€)
de 1 a 10 mm	19 peças	1	D-67583	0088381549219	62,00

Estojo de brocas para metal HSS-G



★★★

Ø (mm)	Conteúdo	Un.	Código	EAN	P.V.P. (€)
de 1 a 10 mm	19 peças	1	D-67549	0088381549172	46,00

Estojo de brocas para metal HSS-TIN



★★

Ø (mm)	Conteúdo	Un.	Código	EAN	P.V.P. (€)
de 1 a 10 mm	19 peças	1	D-67527	0088381548243	23,00

Estojo de brocas para metal HSS-TIN



★★

Ø (mm)	Conteúdo	Un.	Código	EAN	P.V.P. (€)
de 2 a 8 mm	6 peças	1	D-72833	0088381577342	6,00

Estojo de brocas para metal HSS-R



★

Ø (mm)	Conteúdo	Un.	Código	EAN	P.V.P. (€)
de 1 a 10 mm	19 peças	1	D-54081	0088381450201	18,10

Estojo de brocas para tijolo



★★

★★★



D-72877



E-11536

Ø (mm)	Conteúdo	Un.	Código	EAN	P.V.P. (€)
4, 5, 6, 8 e 10 mm	5 peças	1	D-72877	0088381577380	5,45
4, 5, 6, 8 e 10 mm	5 peças	1	E-11536	0088381582827	7,70

Estojo de brocas para metal, tijolo e madeira



★★★

Conteúdo	Total	Un.	Código	EAN	P.V.P. (€)
6 metal	18 peças	1	D-46202	0088381411776	21,55
6 madeira					
6 tijolo					



★★★

Conteúdo	Total	Un.	Código	EAN	P.V.P. (€)
3 metal	9 peças	1	D-71962	0088381566490	7,95
3 madeira					
3 tijolo					

Estojo de brocas para madeira



★★★

Ø (mm)	Conteúdo	Un.	Código	EAN	P.V.P. (€)
de 4 a 10 mm	5 peças	1	D-72861	0088381577373	4,95

Jogo de brocas de pala para madeira



★★★

Conteúdo	Un.	Tipo	Código	EAN	P.V.P. (€)
8	1	***	E-08698	0088381579605	20,60

Jogo de brocas /4" hexagonal

- Madeira
- Metal



★★★

Conteúdo	Total	Un.	Código	EAN	P.V.P. (€)
3 metal	5 peças	1	D-20769	0088381287760	12,05
2 madeira					

- Madeira
- Metal
- Tijolo



★★★

Conteúdo	Total	Un.	Código	EAN	P.V.P. (€)
2 metal	5 peças	1	D-23759	0088381312844	9,50
2 madeira					
1 tijolo					

Estojo de brocas Omnibohrer Multimaterial



- Brocas para furar todos os tipos de materiais leves como tijolo, madeira, alumínio, plástico e betão
- Adequadas para brocas de 2 modos. Berbequim e berbequim + percussão.
- As brocas Omnibohrer da Makita são mais duradouras do que as brocas multimaterial dos seus concorrentes.

Material	Alumínio	Aço	Linha	Plástico	Tijolo	Madeira	Madeira + plástico	Betão	Alumínio	Metal
Ótimo	Ótimo	Ótimo	Ótimo	Ótimo	Ótimo	Ótimo	Ótimo	Ótimo	Ótimo	Ótimo
Bom	Bom	Bom	Bom	Bom	Bom	Bom	Bom	Bom	Bom	Bom
Não recomendado	Não recomendado	Não recomendado	Não recomendado	Não recomendado	Não recomendado	Não recomendado	Não recomendado	Não recomendado	Não recomendado	Não recomendado

○ Excelente △ Bom X Não recomendado

Ø (mm)	Comprimento (mm)	Un.	Código	EAN	P.V.P. (€)
5	85	1	D-30477	0088381353335	6,60
6	100	1			
8	110	1			
10	150	1			
12	150	1			

Estojos de pontas e brocas cilíndricas

★★★



Conteúdo	Un.	Tipo	Código	EAN	P.V.P. (€)
29 peças	1	***	E-07054	0088381571258	24,00

Estojos de pontas e brocas SDS-PLUS

★★★



Conteúdo	Un.	Código	EAN	P.V.P. (€)
18 peças	1	E-07026	0088381571227	29,00

Jogo de pontas, caixas + escareador

★★



Conteúdo	Un.	Código	EAN	P.V.P. (€)
Pontas, escareadores, porta-brocas magnético, chaves de caixa...	1	D-73461	0088381584821	30,00

Jogo de pontas + escareador

★★



Conteúdo	Un.	Código	EAN	P.V.P. (€)
Pontas, escareadores e porta-brocas magnético...	1	D-73477	0088381584838	28,00

Estojo de brocas e brocas

★★★



- 4 brocas de alvenaria: 4 x 75 mm, 5 x 85 mm, 6 x 100 mm, 8 x 120 mm.
- 4 brocas para metal: 3 x 65 mm, 4 x 75 mm, 5 x 85 mm, 6 x 95 mm.
- 8 pontas de 25 mm: PH2, PZ2, PH3, PZ3, Plano 0,8 x 5,5 Plano 1,2 x 6,5 T20, T25.
- Porta-pontas magnético.

Conteúdo	Un.	Código	EAN	P.V.P. (€)
17 peças	1	D-40200	0088381401869	14,95

★★★



- Pontas de 25 mm PH, PZ e T.
- Brocas de pala 10 - 25 mm.
- Pontas de 50 mm PH, PZ e T.
- Brocas HSS-R de 1,5 - 6 mm.

Conteúdo	Un.	Código	EAN	P.V.P. (€)
71 peças	1	B-50295	0088381463317	38,00



Jogo de brocas com escareador 4 peças

★★

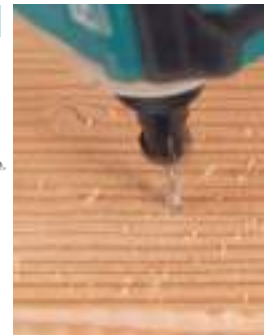

Ø (mm)	Un.	Código	EAN	P.V.P. (€)
6 - 8 - 10 - 12	1	D-73455	0088381584722	8,75

Malas de acessórios



★★★

- 30 pontas de 25 mm PH, PZ, T, SL e H.
- 20 pontas de 50 mm PH, PZ, T, SL e H.
- Porta-brocas magnético.
- 13 chaves de caixa.
- Chave sextavada.
- Punção central.
- Escareador.
- Brocas para madeira 3, 4, 5, 5,5, 6, 6,5.
- Adaptador de coroa.
- Brocas para metal HSS-TIN: 3, 4, 5, 5,5, 6, 6,5.
- Brocas para alvenaria: 3, 4, 5, 5,5, 6, 6,5.
- Brocas planas hexagonais: 12, 16, 19.
- 4 brocas de coroa: 32, 38, 40, 54.
- Nível.
- Fita métrica 3 m.
- Medidor de diâmetro. Ponta para gesso.

Conteúdo	Un.	Tipo	Código	EAN	P.V.P. (€)
102 peças	1	***	E-10730	0088381580557	54,00



★★★

- Brocas HSS-TIN: 1, 1,5, 2, 2,5, 3, 3,5, 4, 4,5, 5, 5,5, 6, 6,5 e 7 mm
- Brocas para alvenaria: 3, 4, 5, 5,5, 6, 6,5, 7, 8, 9, e 10 mm
- Brocas para madeira: 3, 4, 5, 6, 8 e 10 mm
- Pontas de 25 mm: PH - PZ - SL, Hex e T.
- Pontas de 50 mm: PH -PZ - SL - Hex e T.
- Chaves de caixa.
- Ponta magnética para pladur de 30 mm
- Porta-pontas magnético de 60 mm.
- Escareador de 36 mm.
- Batentes de profundidade: 3, 5 e 8 mm.
- Chave Allen de 2,5 mm.
- Calibre para brocas.

Conteúdo	Un.	Tipo	Código	EAN	P.V.P. (€)
102 peças	1	***	B-68432	0088381546072	44,00



★★★

- Brocas de metal 1 - 1,5 - 2 - 2,5 - 3 - 3,2 - 3,5 - 4 - 4,5 - 5 - 5,5 - 6 - 6,5 - 7 - 7,5 - 8 - 9 e 10 mm.
- Brocas para alvenaria: 3 - 4 - 4,5 - 5 - 5,5 - 6 - 6,5 - 7 - 8 e 10 mm.
- Brocas para madeira: 3 - 4 - 5 - 6 - 7 - 8 - 9 e 10 mm.
- Brocas de pala para madeira: 10 - 12 - 16 - 18 - 20 - 22 - 25 - 12 e 14 mm.
- Pontas de 25 mm: PH - PZ - SL - Hex - T e SQ.
- Pontas de 50 mm: PH - PZ - SL e Hex.
- Chaves de caixa.
- Escareador de 12,7.
- Porta-pontas magnético de 60 mm.
- Batentes de profundidade: 3 - 5 - 6 - 8 e 10 mm.
- Chave Allen de 2,5 mm.
- Calibre para brocas.
- Brocas de coroa com adaptador (mm): 32 - 38 - 44 - 54.
- Régua Makita 3 m x 13 mm.
- Nível.
- Chave de fendas magnético manual e chave de fendas manual.
- Punções.
- Lápis de carpinteiro.
- Porta-pontas flexível.

Conteúdo	Un.	Tipo	Código	EAN	P.V.P. (€)
212 peças	1	***	E-06270	0088381568746	97,00



★★★

- Brocas de metal HSS-R: 1 - 1,5 - 2 - 2,5 - 3 - 3,2 - 3,5 - 4 - 4,5 - 5 - 5,5 - 6 - 7 - 7,5 e 8 mm
- Brocas para madeira: 3 - 4 - 5 - 6 - 7 - 8 - 9 e 10 mm.
- Brocas de pala para madeira: 12 - 16 - 20 - 22 - 25 - 12 e 14 mm.
- Brocas para alvenaria: 3 - 4 - 4,5 - 5 - 6 - 7 - 8 e 10 mm.
- Escareador de 36.
- Pontas de 25 mm: PH - PZ - SL - T e H3
- Pontas de 50 mm: PH e PZ.
- Adaptador de troca de inserção 1/4" 3/8"
- Porta-pontas magnético de 60 - 80 mm.
- Chaves de caixa.
- Brocas de coroa
- Adaptador de brocas de coroa de 90 mm
- Calibre para brocas.
- Chave Allen de 2,5 mm.
- Batentes de profundidade: 3 - 5 - 6 - 8 e 10 mm
- Jogo de chaves Allen (mm)
- Jogo de chaves Allen (polegadas)
- Régua Makita 3 m x 13 mm.
- Cortador
- Nível.
- Chave de fendas manual
- Chave inglesa
- Lápis de carpinteiro de 150 mm.
- Ponta magnética para paredes divisórias secas.

Conteúdo	Un.	Tipo	Código	EAN	P.V.P. (€)
216 peças	1	***	E-11689	0088381585019	113,00

Mala de acessórios



★★★

- Pontas de 25 mm PH, PZ, T, SL e H. mm.
- Estojo 25 pontas 25 mm PZ2.
- Pontas de 60 mm PH, PZ e T.
- Porta-pontas.
- Escareador.
- Chave de caixa 1/4 Hex. 6, 8 e 10 mm.
- Brocas para madeira 3, 4, 5, 6 e 8 mm.
- Brocas Widia de 6, 7 e 8 mm.
- Brocas de pala de 12 e 16 mm.
- Brocas de coroa bimetálica 32 e 38 mm.
- Adaptador de coroa.
- Brocas HSS de 2, 3, 4, 5 e 8 mm.

Conteúdo	Un.	Tipo	Código	EAN	P.V.P. (€)
100 peças	1	***	B-54520	0088381477802	53,00

Malas de acessórios Maccess

MACCESS

- Estojo de 34 peças:
- Brocas de metal HSS-R.
- Chaves de caixa.
- Porta-pontas magnético
- Brocas para alvenaria.
- Escareador.
- Brocas para madeira.
- Pontas de várias medidas.

★★★★★



Conteúdo	Un.	Código	EAN	P.V.P. (€)
34 peças	1	D-36980	0088381374248	27,00

★★★★★



- Estojo de 71 peças:
- Brocas de metal HSS-Tin.
- Brocas para alvenaria.
- Brocas para madeira.
- Brocas de pala.
- Escareador.
- Fita métrica (3 M).
- Lâmina.
- Porta-pontas magnético.
- Chaves de caixa
- Chave de fendas.
- Pontas de várias medidas.

Conteúdo	Un.	Código	EAN	P.V.P. (€)
71 peças	1	D-33691	0088381360586	68,00

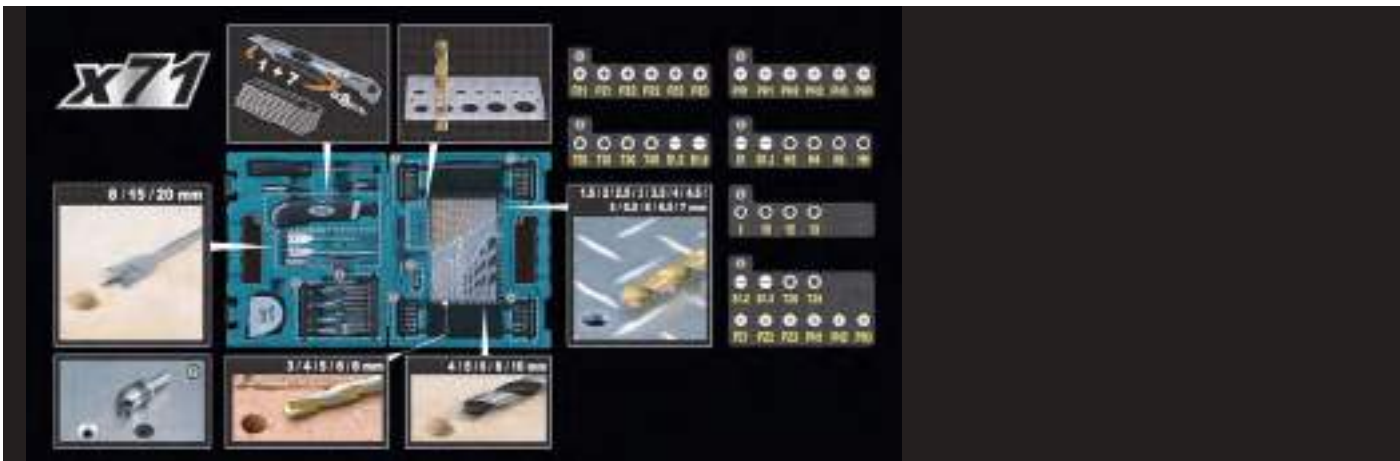

Malas de acessórios Maccess



- Caixa de 104 peças:
- Brocas de metal HSS-Tin.
- Brocas para alvenaria.
- Brocas para madeira.
- Brocas de pala.
- Escareador.
- Metro (3 m).
- Cortador.
- Porta-pontas magnético.
- Chaves de caixa.
- Chave de fendas.
- Batentes de profundidade.
- Nível.
- Pontas de várias medidas.



Conteúdo	Un.	Código	EAN	P.V.P. (€)
104 peças	1	D-31778	0088381358590	89,00

x104

1 + 7 = 8 pcs.

1.5 / 2 / 2.5 / 3 / 3.5 / 4 / 4.5 / 5 / 5.5 / 6 / 6.5 / 7 / 8 / 10 mm

8 / 15 / 20 mm

3 / 4 / 5 / 6 / 8 mm

3 / 4 / 5 / 6 / 7 / 8 / 10 mm

31 31.2 31.4 31.6 31.8 32 32.2 32.4 32.6 32.8 33

34 34.2 34.4 34.6 34.8 35 35.2 35.4 35.6 35.8 36

37 37.2 37.4 37.6 37.8 38 38.2 38.4 38.6 38.8 39

41 41.2 41.4 41.6 41.8 42 42.2 42.4 42.6 42.8 43

45 45.2 45.4 45.6 45.8 46 46.2 46.4 46.6 46.8 47

49 49.2 49.4 49.6 49.8 50 50.2 50.4 50.6 50.8 51

55 55.2 55.4 55.6 55.8 56 56.2 56.4 56.6 56.8 57

61 61.2 61.4 61.6 61.8 62 62.2 62.4 62.6 62.8 63

65 65.2 65.4 65.6 65.8 66 66.2 66.4 66.6 66.8 67

71 71.2 71.4 71.6 71.8 72 72.2 72.4 72.6 72.8 73

75 75.2 75.4 75.6 75.8 76 76.2 76.4 76.6 76.8 77

81 81.2 81.4 81.6 81.8 82 82.2 82.4 82.6 82.8 83

85 85.2 85.4 85.6 85.8 86 86.2 86.4 86.6 86.8 87

91 91.2 91.4 91.6 91.8 92 92.2 92.4 92.6 92.8 93

95 95.2 95.4 95.6 95.8 96 96.2 96.4 96.6 96.8 97

101 101.2 101.4 101.6 101.8 102 102.2 102.4 102.6 102.8 103

105 105.2 105.4 105.6 105.8 106 106.2 106.4 106.6 106.8 107

111 111.2 111.4 111.6 111.8 112 112.2 112.4 112.6 112.8 113

115 115.2 115.4 115.6 115.8 116 116.2 116.4 116.6 116.8 117

Estojos de acessórios Maccess



- Estajo de 200 peças:
- Brocas de metal HSS-Tin.
- Brocas para alvenaria.
- Brocas para madeira.
- Brocas de pala.
- Escareador.
- Fita métrica (5 M).
- Lâmina.
- Porta-pontas magnético.
- Chaves de caixa.
- Chave de fendas.
- Batentes de profundidade.
- Nível.
- Extensores de aparafusamento.
- Chave inglesa.
- Brocas de coroa.
- Alicates de ponta.
- Alicates de corte.
- Lanterna.
- Pontas de várias medidas.



Conteúdo	Un.	Código	EAN	P.V.P. (€)
200 peças	1	D-37194	0088381375399	152,00

X200

300 mm

3/5/3/10 mm

MS

LED

5/5.5/6/7/8/9/10/11/12/13 mm

90°

8/15/20 mm

No incluida

3/4/5/6/9 mm
Øx300Hx300 mm

3/4/5/6/7/8/10 mm

1/1.5/2/2.5/3/3.2/3.5/4/4.5/5/5.5/6/6.5/7/8/10 mm

5/6/7/8/9/10/11/13 mm

32/38/45/54/63 mm

1/8 1/4 3/8 1/2 5/8 3/4 7/8 1 1 1/4 1 1/2 1 3/4 2 2 1/4 2 1/2 2 3/4 3 3 1/4 3 1/2 3 3/4 4 4 1/4 4 1/2 4 3/4 5 5 1/4 5 1/2 5 3/4 6 6 1/4 6 1/2 6 3/4 7 7 1/4 7 1/2 7 3/4 8 8 1/4 8 1/2 8 3/4 9 9 1/4 9 1/2 9 3/4 10 10 1/4 10 1/2 10 3/4 11 11 1/4 11 1/2 11 3/4 12 12 1/4 12 1/2 12 3/4 13 13 1/4 13 1/2 13 3/4



Estojos de acessórios Makpac

Jogo de acessórios Makpac B-69478:
Makpac tipo 1.

- Brocas SDS-PLUS para metal HSS-TIN:
 - 3 x 90, 3,5 x 100, 4 x 105, 4,5 x 110, 5 x 116, 5,5 x 123, 6 x 123, 6,5 x 131 mm.
- Brocas SDS-PLUS:
 - 6 x 160, 7 x 160, 8 x 160, 10 x 160, 12 x 160 mm.
- Brocas para madeira:
 - 4 x 105, 5 x 116, 6 x 123, 8 x 147, 10 x 163, 12 x 160 mm.
- Pontas:
 - 2 x PH0, 2 x PH1, 3 x PH, 3 x PH3.
 - 2 x PZ0, 2 x PZ1, 2 x PZ3, 2 x PZ3.
 - 2 x SL4, 2 x SL5, 2 x SL5,5, 2 x SL6,5.
 - H3, H4, H5, H6
 - T10, T15, 2xT20, 2x T25, T30, T40.
- Chaves de caixa:
 - 8, 10, 12, 13 mm.
- Escareador.
- Porta-pontas de 80 mm SDS-PLUS.
- Fita métrica 3 M.



★★★★

Conteúdo	Un.	Código	EAN	P.V.P. (€)
65 peças	1	B-69478	0088381548731	110,00

Jogo de acessórios Makpac B-49638:
Makpac tipo 1.

- Estojo de pontas de 25 mm.
 - Porta-pontas de 60 mm
 - PH0, PH1, 2 x PH2, PH3.
 - PZ0, PZ1, 2 x PZ2, PZ3.
 - SL4, SL4,5, SL5,5, SL6,5.
 - T10, 2 x T15, 2 x T20, 2 x T25, T27, 2 x T30, T40.
 - T10H, T15H, T25H, T27H, T30H, T40H.
 - H3, H4, H5, H6.
- Pack de pontas PH2/PZ2 de 50 mm:
 - 5 x PH2.
 - 5 x PZ2.
- Porta-pontas magnéticos tipo 1/4 Hex tipo "clique".
- Chaves de caixa: 6/8/10/12/13 mm.
- Brocas de pala: 16/20 mm
- Brocas de madeira: 3/4/5/6/8 mm.
- Brocas de metal HSS-G: 3/4/5/6/8 mm.
- Brocas de alvenaria HM: 5/6/8/10 mm.
- Bandeja para colocação de acessórios.



★★★★

Conteúdo	Un.	Código	EAN	P.V.P. (€)
69 peças	1	B-49638	0088381459631	110,00

Jogo de acessórios Makpac B-49725:
Makpac tipo 1.

- 2 Estojos de pontas de 25 mm.
 - Porta-pontas de 60 mm:
 - PH0, PH1, 2 x PH2 e PH3.
 - PZ0, PZ1, 2 x PZ2 e PZ3.
 - SL4, SL4,5, SL5,5 e SL6,5.
 - H3, H4, H5 e H6.
 - T10, 2 x T15, 2 x T20, 2 x T25, T27, 2 x T30 e T40.
 - T10H, T15H, T25H, T27H, T30H e T40H.
 - Cabo porta-pontas.
- Estojo de brocas D-46202.
 - Brocas de metal HSS-G: 3/4/5/6/8/10 mm.
 - Brocas de madeira: 3/4/5/6/8/10 mm.
 - Brocas de alvenaria HMCT: 3/4/5/6/8/10 mm.
- Fita métrica.
- Cortador (com lâminas sobressalentes).
- Chave de fendas de roquete.



★★★★

Conteúdo	Un.	Código	EAN	P.V.P. (€)
96 peças	1	B-49725	0088381460965	139,00

Jogo de acessórios Makpac B-49884:
Makpac tipo 1.









- Estojo de brocas D-46202.
 - Brocas de metal HSS-G: 3/4/5/6/8/10 mm.
 - Brocas de madeira: 3/4/5/6/8/10 mm.
 - Brocas de alvenaria HMCT: 3/4/5/6/8/10 mm.
- Jogo de brocas, pontas e caixas.
 - Brocas de metal HSS-G: 3/4/5/6/8/10 mm.
 - Pontas de 25 mm:
 - 2 x PH1, 2 x PH2 e PH3.
 - 2 x PZ1, 2 x PZ2 e PZ3.
 - T10, 2 x T15, 2 x T20, 2 x T25, 2 x T30 e T40.
 - SL4,5, 2 x SL5,5 e 2 x SL6,5.
 - H2, H2,5, H3, H4, 2 x H5 e 2 x H6.
 - Chaves de caixa 1/4 Hex: 4/5/6/8/10 mm.
 - Porta-pontas magnéticos tipo 1/4 Hex tipo "clique".
- Estojo de pontas e chaves de caixa:
 - Pontas de 25 mm:
 - 2 x PH1, 2 x PH2 e PH3.
 - 2 x PZ1, 2 x PZ2 e PZ3.
 - T10, 2 x T15, 2 x T20, 2 x T25, 2 x T30 e T40.
 - 2 x SL4,5, 2 x SL5,5 e 2 x SL6,5.
 - H2, H2,5, H3, H4, 2 x H5 e 2 x H6.
 - Chaves de caixa 1/4 Hex: 4/5/6/8/10 mm.
 - Porta-pontas magnéticos tipo 1/4 Hex tipo "clique".
 - Chave de fendas de roquete.
- Fita métrica de 3 m.
- Cortador (com lâminas sobressalentes).
- Lanterna LED (sem pilhas).



★★★★

Conteúdo	Un.	Código	EAN	P.V.P. (€)
116 peças	1	B-49884	0088381462037	149,00

Brocas de coroa

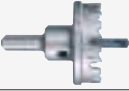
Aplicação	Alumínio 	Aço inoxidável 	PVC 	Aço 	Metais não ferrosos 	Madeira 	Epóxi 
✓ Recomendado • Válido							
Ezychange 	✓	•	•	✓	✓	•	
BIM 	•		✓	✓	•	✓	
TCT 	•	✓	✓	✓	•		✓
Conselhos	Usar óleo de corte	Baixas Rpm usar com óleo de corte		Usar óleo de corte	Usar óleo de corte		

Brocas de coroa bimetálicas



Aplicação:
Para aço, ferro, metal, madeira ou plástico.

Ø (mm)	Comprimento (mm)	Comprimento útil (mm)	Un.	Código	EAN	P.V.P. (€)
14	50	38	1	D-35368	0088381369015	3,40
16	50	38	1	D-16994	0088381194792	3,50
17	50	38	1	D-35374	0088381369022	4,00
19	50	38	1	D-17005	0088381194808	3,95
20	50	38	1	D-17251	0088381195805	4,25
21	50	38	1	D-35380	0088381369039	4,50
22	50	38	1	D-17011	0088381194815	4,50
24	50	38	1	D-17027	0088381194822	5,10
25	50	38	1	D-17033	0088381194839	5,10
27	50	38	1	D-35396	0088381369046	5,10
29	50	38	1	D-17267	0088381195812	5,10
30	50	38	1	D-35405	0088381369053	5,35
32	44	38	1	D-17049	0088381194853	5,40
33	44	38	1	D-35411	0088381369060	5,65
35	44	38	1	D-17055	0088381194860	5,95
37	44	38	1	D-35427	0088381369077	5,95
38	44	38	1	D-17061	0088381194877	5,95
40	44	38	1	D-17273	0088381195829	6,25
41	44	38	1	D-35433	0088381369084	6,50
43	44	38	1	D-35449	0088381369091	6,80
44	44	38	1	D-17077	0088381194884	6,80
46	44	38	1	D-35455	0088381369107	7,35
48	44	38	1	D-35461	0088381369114	7,65
51	44	38	1	D-17083	0088381194891	7,95
52	44	38	1	D-35477	0088381369121	7,65
54	44	38	1	D-24876	0088381334778	7,65

Ø (mm)	Comprimento (mm)	Comprimento útil (mm)	Un.	Código	EAN	P.V.P. (€)
56	44	38	1	D-35483	0088381369138	8,30
57	44	38	1	D-17099	0088381194907	8,30
59	44	38	1	D-35499	0088381369145	8,30
60	44	38	1	D-25688	0088381338516	8,35
64	44	38	1	D-30140	0088381351263	8,90
65	44	38	1	D-24882	0088381334785	8,85
67	44	38	1	D-35508	0088381369152	9,50
68	44	38	1	D-17108	0088381194914	9,55
70	44	38	1	D-25694	0088381338523	10,20
73	44	38	1	D-35514	0088381369169	10,50
76	44	38	1	D-17114	0088381194921	10,75
79	44	38	1	D-35520	0088381369176	10,75
83	44	38	1	D-17120	0088381194938	11,05
86	44	38	1	D-35536	0088381369183	11,05
89	44	38	1	D-35542	0088381369190	11,90
92	44	38	1	D-17136	0088381194945	11,90
95	44	38	1	D-35558	0088381369206	12,15
98	44	38	1	D-35564	0088381369213	12,45
102	44	38	1	D-35570	0088381369220	13,15
105	44	38	1	D-17142	0088381194952	13,60
108	44	38	1	D-35586	0088381369237	15,00
111	44	38	1	D-35592	0088381369244	15,55
114	44	38	1	D-35601	0088381369251	16,15
121	44	38	1	D-35617	0088381369268	16,70
127	44	38	1	D-17158	0088381194969	17,25
140	44	38	1	D-35623	0088381369275	18,95
152	44	38	1	D-17164	0088381194983	20,40

Brocas de coroa



Makita

Adaptador com broca centradora para coroas bimetálicas



Makita

Broca centradora para coroas bimetálicas



Ø (mm)	Tipo	Un.	Código	EAN	P.V.P. (€)
14-29	10 Hex	1	D-17170	0088381194976	4,05
32-152	13 Hex	1	D-17186	0088381195003	7,35
14-29	SDS-PLUS	1	D-17603	0088381196727	5,95
32-76	SDS-PLUS	1	D-17619	0088381196734	9,70

Ø (mm)	Comprimento (mm)	Un.	Código	EAN	P.V.P. (€)
6	71	1	D-17192	0088381194990	2,95

Estojos de brocas de coroa bimetálicas



D-47298

D-47117

Ø (mm)	Uso	Un.	Código	EAN	P.V.P. (€)
19, 22, 25, 29, 35, 44, 51, 57, 68 e 75	Canalização	1	D-47298	0088381424370	102,00
19, 22, 29, 38, 44 e 57	Canalização	1	D-47117	0088381423731	45,00



D-47123

Ø (mm)	Uso	Un.	Código	EAN	P.V.P. (€)
16, 20, 25, 32, 40 e 51	Eletricidade	1	D-47123	0088381423748	38,00
20, 25, 32, 40, 51 e 65	Eletricidade	1	D-47139	0088381423755	45,00

Brocas de coroa Ezychange



Brocas bimetálicas de cobalto adequadas para: madeira, metal, alumínio, aço inoxidável e plástico.



CLIQUE



CLIQUE



ALTA QUALIDADE com 8 % de COBALTO PARA UMA MAIOR DURAÇÃO

Ø (mm)	Comprimento (mm)	Comprimento Útil (mm)	Un.	Código	EAN	P.V.P. (€)
16	46	40	1	B-11265*	0088381352314	8,00
17	46	40	1	B-31706	0088381419161	8,00
19	46	40	1	E-03654	0088381561891	8,00
20	46	40	1	E-03660	0088381561907	8,00
22	46	40	1	E-03676	0088381561914	8,50
25	46	40	1	E-03698	0088381561938	10,30
27	46	40	1	E-03707	0088381561945	9,80
29	46	40	1	E-03713	0088381561952	9,80
32	46	40	1	E-03735	0088381561976	10,20
37	46	40	1	E-03757	0088381561990	10,80
38	46	40	1	E-03763	0088381562003	10,30
40	46	40	1	E-03779	0088381562010	11,35
41	46	40	1	E-03785	0088381562027	11,35
44	46	40	1	E-03791	0088381562034	11,85
46	46	40	1	E-03800	0088381562041	11,85
51	46	40	1	E-03822	0088381562065	12,35

Ø (mm)	Comprimento (mm)	Comprimento Útil (mm)	Un.	Código	EAN	P.V.P. (€)
52	46	40	1	E-03838	0088381562072	13,15
56	46	40	1	E-03850	0088381562096	14,15
60	46	40	1	E-03872	0088381562119	14,15
66	46	40	1	E-03894	0088381562133	15,00
73	46	40	1	E-03925	0088381562164	16,20
76	46	40	1	E-03931	0088381562171	16,20
79	46	40	1	E-03947	0088381562188	18,55
83	46	40	1	E-03953	0088381562195	19,05
86	46	40	1	E-03969	0088381562201	19,55
95	46	40	1	E-03981	0088381562225	25,00
105	46	40	1	E-04008	0088381562249	25,00
111	46	40	1	E-04014	0088381562256	32,00
114	46	40	1	E-04020	0088381562263	32,00
121	46	40	1	E-04036	0088381562270	36,00
127	46	40	1	E-04042	0088381562287	32,00
152	46	40	1	E-04064	0088381562300	42,00

* azul Makita

Adaptadores para coroas Ezychange



Tipo	Conteúdo	Un.	Código	EAN	P.V.P. (€)
Cilíndrica	Com broca centralizadora	1	E-04070	0088381562317	24,00

Broca centradora



Tipo	Un.	Código	EAN	P.V.P. (€)
HSS	1	E-04086	0088381562324	6,45

Brocas de coroa HM

Brocas de coroa metal duro (alta durabilidade).

Com pastilhas de metal duro, preparadas para suportar as altas temperaturas produzidas pelo corte profundo e contínuo.

Para chapa de aço, aço inoxidável, vigas de ferro (duplo T), etc.

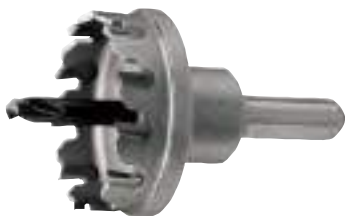

* Para furos de espessura superior a 4 mm, recomenda-se o arrefecimento da broca.



Ø (mm)	Inserção (mm)	Tipo	Un.	Código	EAN	P.V.P. (€)
16	6	HM	1	B-00898	0088381114004	49,00
18	6	HM	1	B-00907	0088381114011	51,00
20	6	HM	1	B-00913	0088381114028	51,00
21	6	HM	1	B-00929	0088381114035	51,00
22	6	HM	1	B-00935	0088381114042	51,00
25	10	HM	1	B-00941	0088381114059	51,00
27	10	HM	1	B-00957	0088381114066	52,00
30	10	HM	1	B-00979	0088381114080	54,00
32	10	HM	1	B-00985	0088381114097	63,00
35	10	HM	1	B-00991	0088381114103	63,00
38	10	HM	1	B-01002	0088381114110	74,00
40	10	HM	1	B-01018	0088381114127	75,00
45	10	HM	1	B-01024	0088381114134	82,00
48	10	HM	1	B-01030	0088381114141	91,00
50	10	HM	1	B-01046	0088381114158	94,00
60	13	HM	1	B-01068	0088381114172	134,00
90	13	HM	1	B-01127	0088381114288	236,00

Brocas centradora para brocas HM



Ø (mm)	Tipo	Uso	Un.	Código	EAN	P.V.P. (€)
6	HSS	Aço	1	B-01177	0088381114233	9,80
8	HSS	Aço	1	B-01183	0088381114240	10,30
6	HM	Resina, FRP...	1	B-01199	0088381114301	11,85
8	HM	Resina, FRP...	1	B-01208	0088381114318	14,40

Batedores

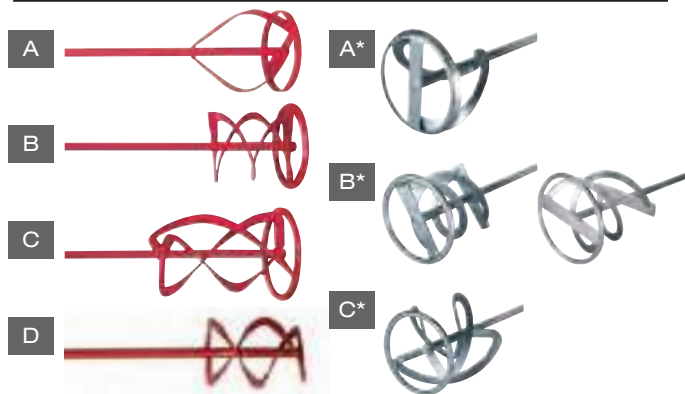

A	Para tintas, lacas, gesso, revestimentos finos, etc.
B e D	Todos os materiais viscosos, adequados para todos os tipos de argamassa, gesso, resinas de epóxi com enchimento de quartzo, etc.
C	Para todos os materiais pegajosos e viscosos, por exemplo, colagem de azulejos, argamassas, gessos, enchimentos, etc.

Inser.	Ø (mm)	Compr. (mm)	Tipo	Modelos	Un.	Código	EAN	P.V.P. (€)	
8	80	400	A	DA6301 DS4010	1	P-02331	0088381918527	14,40	
10	90	400	D		1	P-02347	0088381918534	13,90	
8	100	590	C	UT1200 UT1400 UT1401 UT1600	1	P-02353	0088381918541	32,00	
M14	90	590	D		1	P-22028	0088381949088	25,00	
M14	120	590	A		1	P-22012	0088381949071	24,00	
M14	140	590	B		1	P-22040	0088381949101	31,00	
M14	120	590	C		1	P-22056	0088381949118	36,00	
M14	120	600	A*		1	D-73508	0088381584869	16,20	
M14	120	600	B*		1	D-73514	0088381584876	17,35	
M14	120	600	C*		1	D-73520	0088381584883	17,35	
10	120	600	B*		DA6301 DS4010	1	D-73542	0088381584906	10,40

Adaptadores para batedores



Modo de utilização: Para utilizar um batedor de inserção M14 num berbequim, é necessário desmontar o porta-brocas, colocar o adaptador no seu lugar e inserir o batedor mais adequado para o tipo de trabalho na outra extremidade.

Ø (mm)	Inserção	Modelo	Un.	Código	EAN	P.V.P. (€)
1/2"	M14	6013B/ DP4002	1	P-22062	0088381949125	10,30
5/8"	M14	DA6301	1	P-02325	0088381918510	10,30

Disco misturador (sem haste A-43751)



Ø (mm)	Inserção	Modelo	Un.	Código	EAN	P.V.P. (€)
165 mm	M8	DUT130	1	A-43692	0088381198707	13,45

Vareta para misturador de inox A-43692



Ø (mm)	Inserção	Modelo	Un.	Código	EAN	P.V.P. (€)
1/2"	M14	6013B/ DP4002	1	A-43751	0088381198769	26,00



Extensão DA4000LR



DA4000LR com extensão.

Modelos	Comprimento (mm)	Un.	Código	EAN	P.V.P. (€)
DA4000LR	760	1	193317-9	0088381160971	235,00

Batentes de profundidade



Modelos	Un.	Código	EAN	P.V.P. (€)
DP2010 DP2011	1	322177-4	0088381126441	1,10
HP1620/1 HP2033 HP2050/1 HP2070/1	1	415486-9	0088381147033	0,90
DP4011	1	324219-0	0088381171458	1,85



Suporte de berbequim e acessórios

Suporte de berbequim [a]



* Colar de aperto de 43 mm.

Un.	Código	EAN	P.V.P. (€)
1	A-36706*	0088381183130	370,00

Suporte de paragem horizontal [b]



Un.	Código	EAN	P.V.P. (€)
1	501329	-	34,00

Grampo horizontal [c]

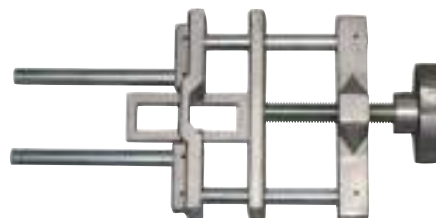

Un.	Código	EAN	P.V.P. (€)
1	132126-1	-	158,00



Suporte de guia e acessórios

Suporte de guia

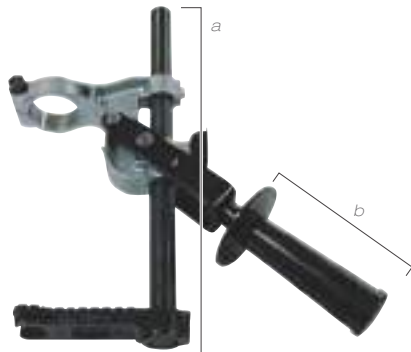

Vista explodida	Un.	Código	EAN	P.V.P. (€)
[a] Garra: 134279-2	1	501353	-	162,00
[b] Punho: 273466-9				

Kit de suporte (base + alavanca)



Kit completo
(máquina não incluída)

2

Vista explodida	Un.	Código	EAN	P.V.P. (€)
[1+2] Kit completo	1	501043	-	185,00
[a] Alavanca: 155696-3	1	501035	-	25,00
[b] Parafuso: 924306-1				
[c] Parafusos (2 un.): 912317-8				
[d] Base: 342802-1				

Base em "V"

Para usar com o SUPORTE DE GUIA 501353



Vista explodida	Un.	Código	EAN	P.V.P. (€)
[a] Base em V: 163221-6	1	501036	-	10,30
[b] Parafuso: 911321-4				

Batente de ajuste

Para usar com o SUPORTE DE GUIA 501353

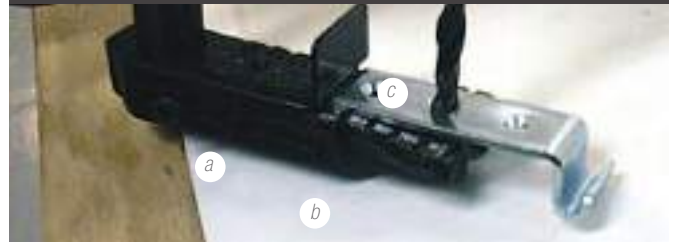

Vista explodida	Un.	Código	EAN	P.V.P. (€)
[a] Arruela: 941101-4	1	501037	-	4,40
[b] Parafuso: 251259-4				
[c] Batente: 342804-7				







Alargador de base

Para usar com o SUPORTE DE GUIA 501353



Vista explodida	Un.	Código	EAN	P.V.P. (€)
[a] Parafuso (2 un.): 911321-4	1	501038	-	4,65
[b] Suplemento: 342818-6				

Porta-brocas automático

Tipo	Imagem	Modelos	Capacidade (mm)	Passo	Fecho/chave	Un.	Código	EAN	P.V.P. (€)
Automático		HP1631 6310 HP1641	1,5 - 13	1/2" - 20	Lock	1	P-15718	0088381932202	36,00
		HP2051 HP2071 DP4011	1,5 - 13	1/2" - 20	Lingueta	1	194254-0	0088381206907	48,00
		6317D 6337D 6347D	1,5 - 13	1/2" - 20	Padrão	1	766010-4	-	29,00
		DP3003	1,0 - 10	1/2" - 20	Lock	1	193226-2	0088381150347	33,00
		6501X DP2011	0,8 - 6,5	3/8" - 24	Padrão	1	193203-4	0088381157285	34,00
		6413	1,0 - 10	3/8" - 24	Padrão	1	763180-0	0088381189156	9,30
		6408 DA3011F	1,0 - 10	3/8" - 24	Lock	1	192282-9	0088381119832	31,00
		DF331D	1,0 - 10	3/8" - 24	-	1	763228-8	-	11,55
		HP331D	1,0 - 10	3/8" - 24	-	1	763229-6	-	9,40
		6261D 6271D 6281D	0,8 - 10	1/2" - 24	-	1	766002-3	0088381350549	9,80
		DF330D	0,8 - 10	3/8" - 24	-	1	766007-3	0088381354219	10,80
		8270D 8280D	0,8 - 10	1/2" - 20	-	1	763187-6	0088381196192	14,40
		6260D 6270D 6280D	0,8 - 10	1/2" - 20	-	1	763185-0	0088381192873	10,60
		8391D	0,8 - 10	1/2" - 20	-	1	766004-9	0088381359825	14,05

Porta-brocas manual

Tipo	Imagem	Modelos	Capacidade (mm)	Passo	Fecho/chave	Un.	Código	EAN	P.V.P. (€)
Manual		6501 DP2010	0,5 - 6,5	3/8" - 24	763435-3	1	763077-3	0088381114837	5,20
		6413 6408 DA3011F	1,0 - 10	3/8" - 24	-	1	P-11835*	-	12,35
		HP1620	1,5 - 13,0	1/2" - 20	763440-0	1	196008-1*	0088381433792	11,35
		HP1640	1,5 - 13,0	1/2" - 20	763448-4	1	766016-2	-	9,00
		HP2050 HP2070 DS4012	1,5 - 13,0	1/2" - 20	763430-3	1	193822-6*	0088381184250	26,00
		HP2010N 6300-4 6013B	1,5 - 13,0	1/2" - 20	763432-9	1	192877-8	0088381147934	35,00
		DP4000 DP4002	1,5 - 13,0	1/2" - 20	763434-5	1	193228-8	0088381158183	37,00
		DP3002	1,0 - 10,0	1/2" - 20	763434-5	1	193224-6	0088381158176	40,00
		DA4031	2,0 - 13,0	***	763432-9	1	193519-7	0088381164597	51,00
		DA6301	1,5 - 13,0	5/8" - 16	763432-9	1	763062-6	0088381102223	42,00
		DA4000LR	2,0 - 13,0	***	763432-9	1	193318-7	0088381160957	48,00
		DA3010F	1,0 - 10,0	**	763415-9	1	763174-5	0088381181945	38,00
		MT603	1,0 - 10,0			1	193706-8	0088381193078	6,70



Aparafusamento

IMPACT BLACK



Impact
PREMIER



Índice

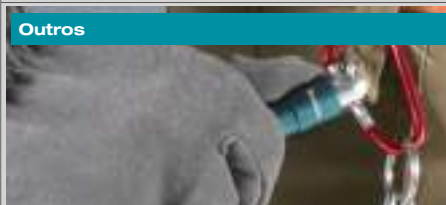
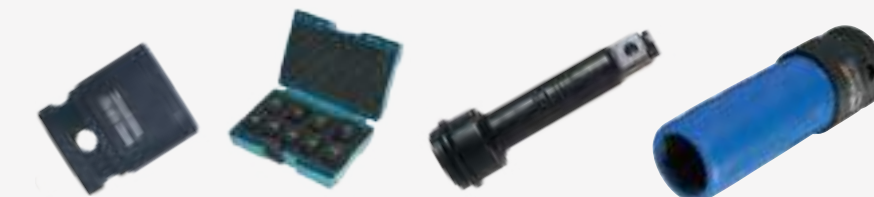
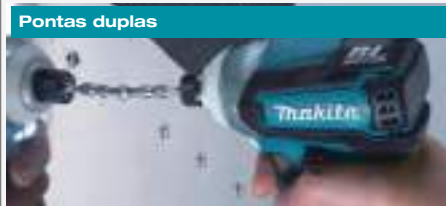
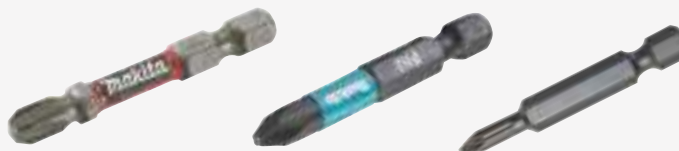

Impact PREMIER



Apresentamos a nossa melhor gama de pontas, porta-pontas e chaves de caixa IMPACT PREMIER, uma gama redesenhada que aumenta a dureza e melhora a qualidade e durabilidade dos nossos acessórios.

- A nova forma de torção torna esta gama perfeita para o trabalho com aparafusadoras de impacto.
- Oferecem um grande ajuste da ponta no parafuso.
- Cada tipo de ponta é diferenciado por uma cor para facilitar o reconhecimento de cada uma.



Impact PREMIER



Maior precisão de ajuste.

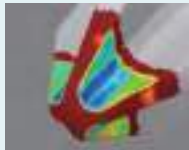

Com um parafuso por perto



Com um parafuso à distância



Impact
PREMIER



Padrão

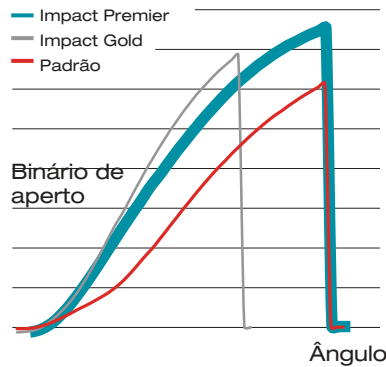

Dupla torção para maior durabilidade.



Pontas Impact Premier



• Novo código de cor:
Cada tipo de ponta tem
uma cor associada.

★★★★★



E-03280

E-03296

E-03355

Ponta	Tipo	Comprimento (mm)	Un.	Código	EAN	P.V.P. (€)
PH ⊕	PH1	25	2	E-03121	0088381569798	3,10
	PH2	25	2	E-03137	0088381569804	3,10
	PH3	25	2	E-03159	0088381569828	3,10
	PH1	50	2	E-03268	0088381569934	6,20
	PH2	50	2	E-03274	0088381569941	6,20
	PH3	50	2	E-03280	0088381570244	6,20
PZ ⊗	PZ1	25	2	E-03165	0088381569835	3,10
	PZ2	25	2	E-03171	0088381569842	3,10
	PZ3	25	2	E-03187	0088381569859	3,10
	PZ1	50	2	E-03296	0088381569958	6,20
	PZ2	50	2	E-03305	0088381569965	6,20
	PZ3	50	2	E-03311	0088381569972	6,20
T ⊗	T10	25	2	E-03193	0088381569866	3,10
	T15	25	2	E-03202	0088381569873	3,10
	T20	25	2	E-03218	0088381569880	3,10
	T25	25	2	E-03224	0088381569897	3,10
	T30	25	2	E-03230	0088381569903	3,10
	T40	25	2	E-12027	0088381585163	4,90
	T10	50	2	E-03327	0088381569989	6,20
	T15	50	2	E-03333	0088381569996	6,20
	T20	50	2	E-03349	0088381570008	6,20
	T25	50	2	E-03355	0088381570015	6,20
T30	50	2	E-03361	0088381570022	6,20	

MagBoost

★★★★★



Mag Boost: porta-pontas magnético de 25 mm.

- Proporciona uma magnetização extra para uma fixação forte do parafuso.
- Ao contrário do Ultramag, o Mag Boost não é um porta-pontas, mas contacta-se diretamente à ponta.
- As pontas devem ter um mínimo de 50 mm. Ideal para pontas longas, qualquer que seja o comprimento, pode sempre ser colocado a apenas alguns milímetros da cabeça.
- Possui uma inserção cilíndrico e, portanto, também é compatível com aparafusadoras manuais (6,35 mm de diâmetro, 1/4" Hex.).



Descrição	Comprimento (mm)	Un.	Código	EAN	P.V.P. (€)
Ímã	25	1	E-03442	0088381570107	4,10

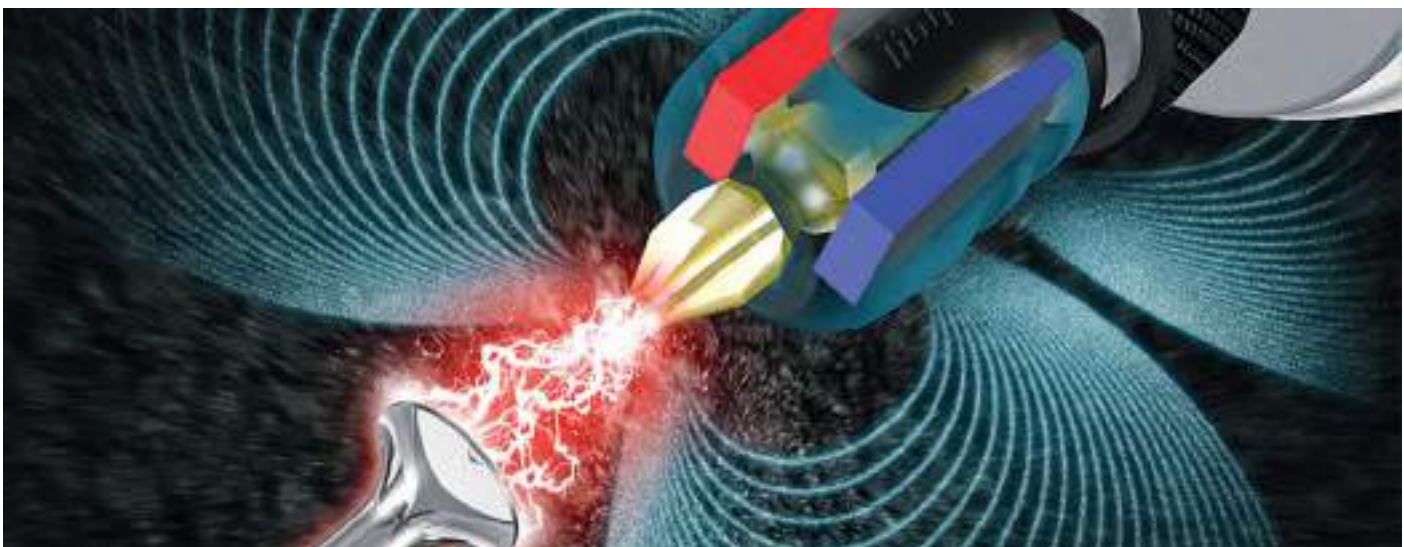

Porta-pontas Ultramag Impact Premier

★★★★★



Tipo	Compr. (mm)	Inserção	Un.	Código	EAN	P.V.P. (€)
Iman de neodímio	79	1/4"	1	E-03414	0088381570077	9,25

Estojo de pontas Impact Premier

- Porta-pontas
- Pontas PH: PH2.
- Pontas PZ: Pz1, 2x Pz2 e Pz3.
- Pontas em T: T20, T25 e T30.
- Pontas planas: SL4 e SL6.

★★★★★



Conteúdo	Un.	Código	EAN	P.V.P. (€)
11 peças	1	E-03573	0088381570213	23,00

Adaptador móvel

★★★★★



E-03420

E-03436

Inserção	Comprimento (mm)	Un.	Código	EAN	P.V.P. (€)
1/4" - 3/8"	56	1	E-03420	0088381570084	6,20
1/4" - 1/2"	56	1	E-03436	0088381570091	6,20

Pontas duplas Impact Premier

★★★★★



Ponta	Tipo	Comprimento (mm)	Un.	Código	EAN	P.V.P. (€)
PH	PH2	65	2	E-06286	0088381570220	9,25
PZ	PZ2	65	2	E-06292	0088381570237	9,25

Porta-pontas torção Impact Premier

★★★★★



Tipo	Compr. (mm)	Inserção	Un.	Código	EAN	P.V.P. (€)
Magnético	66	1/4"	1	E-03399	0088381570053	8,00
Magnético	150	1/4"	1	E-03408	0088381570060	8,75

Chaves de caixa móveis Impact Premier

★★★★★



Parafuso	Ø (mm)	Comprimento (mm)	Un.	Código	EAN	P.V.P. (€)
M8	13	80	1	E-03492	0088381570152	8,75
M10	17	80	1	E-03517	0088381570176	9,25
M12	19	80	1	E-03523	0088381570183	9,55

Chaves de caixa magnéticas Impact Premier

★★★★★



Parafuso	Ø (mm)	Comprimento (mm)	Un.	Código	EAN	P.V.P. (€)
M3,5	6	65	1	E-03458	0088381570114	6,20
M5	8	65	1	E-03464	0088381570121	6,20
M6	10	65	1	E-03470	0088381570138	6,20
M8	13	65	1	E-03486	0088381570145	6,45

Pontas para aparafusar Impact Black



Estojo de pontas e chaves de caixa Impact Black

★★★



Ponta	Un.	Código	EAN	P.V.P. (€)
35 peças: PH 3 x PH2 PH3 x 25 mm PH1 2 x PH2 PH3 x 50 mm PZ1 3 x PZ2 PZ3 x 25 mm PZ1 2 x PZ2 PZ3 x 50 mm T15 2 x T20 2 x T25 T30 x 25 mm T15 T20 2 x T25 T30 x 50 mm SL5,5 x 50 mm Chaves de caixa: 6, 8, 10, 13 mm Porta-pontas magnético 60 mm	1	B-66880	0088381540018	40,00

Guia de aparafusamento Impact Black



Descrição	Un.	Código	EAN	P.V.P. (€)
Guia de aparafusamento 80 mm	1	B-66818	0088381539944	5,65

Porta-pontas magnético Impact Black



Descrição	Un.	Código	EAN	P.V.P. (€)
Porta-pontas magnético 60 mm	1	B-66793	0088381539920	4,55

Chaves de caixa Impact Black



Descrição	Medidas (mm)	Un.	Código	EAN	P.V.P. (€)
Chave de caixa magnética	6 x 50	1	B-66824	0088381539951	3,10
Chave de caixa magnética	8 x 50	1	B-66830	0088381539968	3,15
Chave de caixa magnética	10 x 50	1	B-66846	0088381539975	3,10
Chave de caixa magnética	13 x 50	1	B-66852	0088381539982	3,15

IMPACT BLACK



Expositor de cartão Impact Black (10un.)

★★★



Conteúdo	Pç.	Un.	Código	EAN	P.V.P. (€)
Jogo de pontas	33	10	E-12441-10	0088381587792	227,00

Pontas série Impact Black

★★★



PH

PZ

T



PH

PZ

T

Descrição	Comprimento (mm)	Un.	Código	EAN	P.V.P. (€)
PH1	25	2	B-63600	0088381532877	1,65
PH2	25	2	B-63616	0088381532884	1,65
PH3	25	2	B-63622	0088381532891	1,65
PH1	50	2	B-63719	0088381532983	2,45
PH2	50	2	B-63725	0088381532990	2,45
PH3	50	2	B-63731	0088381533003	2,45
PZ1	25	2	B-63638	0088381532907	1,65
PZ2	25	2	B-63644	0088381532914	1,65
PZ3	25	2	B-63650	0088381532921	1,65
PZ1	50	2	B-63747	0088381533010	2,45
PZ2	50	2	B-63753	0088381533027	2,45
PZ3	50	2	B-63769	0088381533034	2,45
T15	25	2	B-63666	0088381532938	1,65
T20	25	2	B-63672	0088381532945	1,65
T25	25	2	B-63688	0088381532952	1,65
T30	25	2	B-63694	0088381532969	1,65
T40	25	2	B-63703	0088381532976	1,65

Descrição	Comprimento (mm)	Un.	Código	EAN	P.V.P. (€)
T15	50	2	B-63775	0088381533041	2,45
T20	50	2	B-63781	0088381533058	2,45
T25	50	2	B-63797	0088381533065	2,45
T30	50	2	B-63806	0088381533072	2,45
T40	50	2	B-63812	0088381533089	2,45
PH2	25	25	E-12360	0088381586566	13,65
PH2	50	10	E-12407	0088381586641	9,80
PZ2	25	25	E-12376	0088381586580	13,65
PZ2	50	10	E-12413	0088381586719	9,80
T20	25	25	E-12382	0088381586603	13,65
T25	25	25	E-12398	0088381586627	13,65
T30	25	25	E-12653	0088381588324	13,65
T40	25	25	E-12669	0088381588348	13,65
T20	50	10	E-12429	0088381586665	9,80
T25	50	10	E-12435	0088381586689	9,80
T30	50	10	E-12675	0088381588362	9,80
T40	50	10	E-12681	0088381588386	9,80





Acessório autoalimentador aparafusamento



- Converta a sua aparafusadora de paredes divisórias secas numa autoalimentada.
- Para colocação de pentes de parafusos padrão.

Parafusos	Modelos	Código	EAN	P.V.P. (€)
25-55 mm	DFS250 - DFS451 - DFS452 FS2300 - FS4000 - FS6300R	191L24-0	0088381566414	95,00



Ponta PH2 130 mm (5 un.) para 199146-8	199155-7	0088381528184	44,00
--	----------	---------------	-------

Pontas para aparafusadoras autoalimentadas



Tipo	Compr. (mm)	Modelos	Un.	Código	EAN	P.V.P. (€)	
PH	PH2	110	6830	1	P-13552	0088381922517	3,70
	PH2	117	DFR440	3	P-66793	0088381997324	12,35
	PH2	127	6832 6833 6835D	1	P-13568	0088381922524	5,90
	PH2	141	6834	1	P-21593	0088381948722	4,65
	PH2	157	6842 DFR550	3	P-67795	0088381998321	16,50
	PH2	177	6844	3	P-67804	0088381998338	19,55
PZ	PZ2	110	6830	1	P-13574	0088381922531	3,60
	PZ2	117	DFR440	3	P-66824	0088381997355	12,35
	PZ2	127	6832 6833 6835D	1	P-13580	0088381922548	5,65
	PZ2	141	6834	1	P-21618	0088381948746	20,10
	PZ2	157	6842 DFR550	3	P-67773	0088381998307	16,50
	PZ2	177	6844	3	P-67789	0088381998314	19,55

Ponta magnética para pladur

★★★



Tipo	Comprimento (mm)	Un.	Código	EAN	P.V.P. (€)	
PH	PH2	30	1	D-61690	0088381477949	1,95

Pontas

★★★★★



- Pontas altamente duradouras para aplicações profissionais e industriais.

Tipo	Comprimento (mm)	Un.	Código	EAN	P.V.P. (€)	
PH	PH1	25	10	P-06030	0088381946773	8,25
	PH2	25	10	P-06052	0088381946797	8,25
	PH3	25	10	P-06074	0088381946810	8,25
	PH2	25	3	798312-0	0088381107846	2,05
	PH1	50	10	P-06046	0088381946780	24,00
	PH2	50	10	P-06068	0088381946803	23,00
PZ	PH3	50	10	P-06080	0088381946827	23,00
	PZ1	25	10	P-06096	0088381944328	8,25
	PZ2	25	10	P-06111	0088381944335	8,25
	PZ3	25	10	P-06133	0088381944342	8,25
	PZ1	50	10	P-06105	0088381946834	23,00
	PZ2	50	10	P-06127	0088381944571	23,00
Plana	PZ3	50	10	P-06149	0088381944588	23,00
	LS0,6 X 4,5	25	10	P-06177	0088381946865	13,40
	LS0,8 X 5,5	25	10	P-06199	0088381946889	13,40
	LS1,0 X 5,5	25	10	P-06214	0088381946902	13,40
Hex.	LS1,2 X 8,0	25	10	P-06242	0088381946933	14,40
	3,0 mm	25	10	P-21375	0088381948524	21,00
	4,0 mm	25	10	P-21381	0088381948531	21,00
	5,0 mm	25	10	P-21397	0088381948548	21,00
	6,0 mm	25	10	P-21406	0088381948555	21,00
	8,0 mm	25	10	P-21412	0088381948562	28,00
T	T10	25	10	P-06323	0088381947015	13,40
	T15	25	10	P-06339	0088381947022	13,40
	T20	25	10	P-06345	0088381947039	13,40
	T25	25	10	P-06351	0088381947046	13,40
	T27	25	10	P-06367	0088381947053	13,40
	T30	25	10	P-06373	0088381947060	13,40
	T40	25	10	P-06389	0088381947077	13,40

Porta-pontas

Rapidfix

★★★★

- Fixação segura e sem folgas do porta-pontas.
- O mecanismo de fixação especial deste porta-pontas permite a reter todo o tipo de pontas com acoplamento hexagonal de 1/4".
- Operação com uma mão para troca rápida da ponta.
- Elegante corpo metálico com casquilho funcional ergonómico. Suporta as condições mais difíceis de aparafusamento e perfuração.
- Recomendado para aparafusadoras de impacto.



Tipo	Compr. (mm)	Inserção	Un.	Código	EAN	P.V.P. (€)
Clique	60	1/4"	1	P-54075	0088381984584	18,00

Clickfix

★★★★

- Magnético.
- Corpo robusto em alumínio.
- Fixação segura das pontas ou brocas.
- Operação com uma mão.
- Casquilho de guia giratório para um aparafusamento mais fácil e seguro.



Tipo	Compr. (mm)	Inserção	Un.	Código	EAN	P.V.P. (€)
Magnético	60	1/4"	1	P-53263	0088381983778	17,50

Porta-pontas 80 mm para SDS-PLUS

★★★



Comprimento (mm)	Inserção	Un.	Código	EAN	P.V.P. (€)
80	SDS - PLUS	1	B-57548	0088381519151	6,20

Padrão

★★

- Magnético.
- Corpo metálico robusto.
- Fixação segura das pontas.



Tipo	Compr. (mm)	Inserção	Un.	Código	EAN	P.V.P. (€)
Magnético	60	1/4"	1	784811-8	0088381430807	3,75
	75	1/4"	1	784801-1	0088381114738	3,20

Porta-pontas flexível

★★★

- Porta-pontas magnético.
- Ideal para aparafusar em cantos ou arestas de difícil acesso.
- O eixo pode ser dobrado para alcançar lugares estreitos onde o aparafusamento é difícil.



Tipo	Compr. (mm)	Inserção	Un.	Código	EAN	P.V.P. (€)
Magnético	200	1/4"	1	B-29072	0088381415507	6,80
Magnético	300	1/4"	1	B-29094	0088381415521	8,50

- Especial impacto.

★★★★★



Tipo	Compr. (mm)	Inserção	Un.	Código	EAN	P.V.P. (€)
Magnético	300	1/4"	1	B-51867	0088381466806	34,00



Caixas especiais para colocação em haste roscada

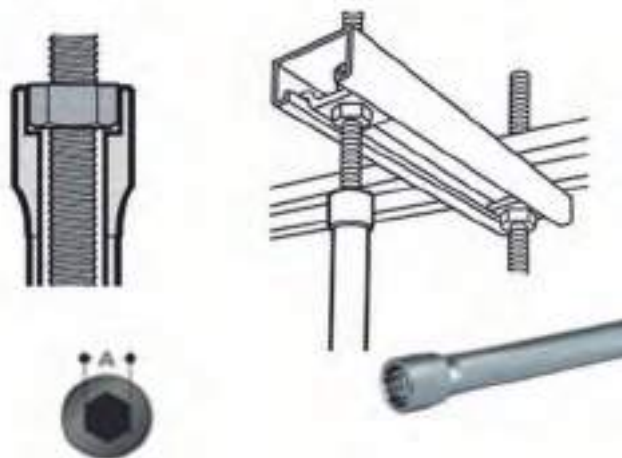

Ø (mm)	Compr. (mm)	Inserção	Un.	Código	EAN	P.V.P. (€)
10	150	1/4"	1	B-52532	0088381469111	25,00
10	300	1/4"	1	B-52548	0088381469128	27,00
10	500	1/4"	1	B-52554	0088381469135	46,00
13	150	1/4"	1	B-52582	0088381469166	25,00
13	300	1/4"	1	B-52598	0088381469173	27,00
13	500	1/4"	1	B-52607	0088381469180	46,00
17	150	1/4"	1	B-52635	0088381469210	27,00
17	300	1/4"	1	B-52641	0088381469227	30,00
17	500	1/4"	1	B-52657	0088381469234	48,00

Chaves de caixa 1/4" hex. destacáveis

Chave de caixa magnética destacável para facilitar a limpeza.

A remoção da caixa revela a haste com as aparas recolhidas. Assim, podemos limpá-la com uma escova ou um papel.

Com as outras chaves de caixa, as aparas ficam retidas no íman. Como não podem ser desmontadas, torna o trabalho mais complicado e a duração mais curta.

- Longa duração, até 20 vezes mais que outras marcas.

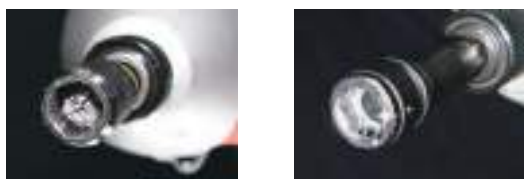

Cada componente é fabricado com o material mais adequado para proporcionar a melhor resistência à rutura.

- Ímã de neodímio para uma fixação extraforte.
- Comprimento total de 61 mm (incluindo a caixa).
- Fornecidas em embalagem blister com haste + caixa.



Parafuso	Ø (mm)	Comprimento (mm)	Un.	Código	EAN	P.V.P. (€)
M5	8	61	1	B-40266	0088381437370	9,80
3/8"	9,6	61	1	B-40272	0088381437387	10,05
M6	10	61	1	B-40288	0088381437394	10,30

Chaves de caixa 1/4" magnéticas



Parafuso	Ø (mm)	Comprimento (mm)	Un.	Código	EAN	P.V.P. (€)
M3	5,5	50	1	B-38685	0088381433327	2,25
M3,5	6	50	1	B-38691	0088381433334	2,25
M4	7	50	1	B-38700	0088381433341	4,50
M5	8	50	1	B-38716	0088381433358	2,30
M6	10	50	1	B-38722	0088381433365	2,25
M8	12	50	1	B-38738	0088381433372	2,30
M8	13	50	1	B-38744	0088381433389	4,55
M10	17	50	1	B-38750	0088381433396	4,55
Para os modelos FS2500 e FS2700						
M6	10	65	1	784806-1	0088381114585	21,00
1/2"	12,7	65	1	784805-3	0088381102735	22,00



Chaves de caixa para colocação de varão roscado

★★★★★



Ø (mm)	Inserção	Un.	Código	EAN	P.V.P. (€)
6	1/4"	1	B-42961	0088381441995	18,00
8	1/4"	1	B-42977	0088381442008	18,55
10	1/4"	1	B-42983	0088381442015	19,05

Adaptador troca de inserção

★★



Descrição	Un.	Código	EAN	P.V.P. (€)
Adaptador 1/4 a 3/8" 50 mm.	1	B-54667	0088381478380	2,70
Adaptador 1/4 a 1/2" 50 mm.	1	B-54673	0088381478397	3,55
Adaptador 1/4 a 3/8" 150 mm.	1	B-57738	0088381521994	8,70
Adaptador 1/4 a 1/2" 150 mm.	1	B-57744	0088381522007	10,65

Jogo de chaves de caixa para Inserção 1/4

★★



Tamanho (mm)	Comprimento (mm)	Un.	Código	EAN	P.V.P. (€)
8 - 10 - 12 - 13	48	1	B-57554	0088381519168	6,25

Kit de montagem rápida

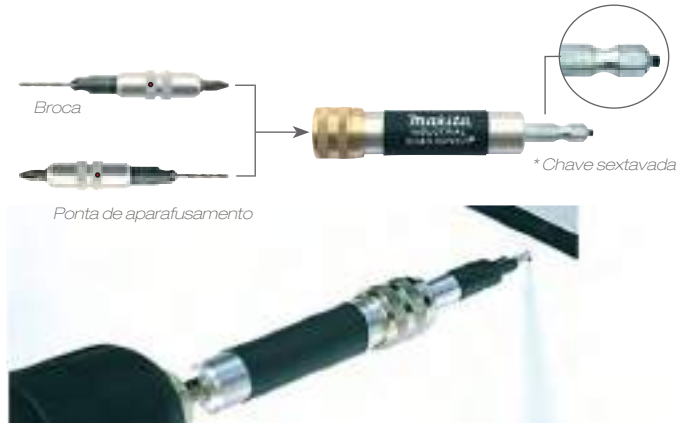

Ø (mm)	Tipo	Un.	Código	EAN	P.V.P. (€)
8	.	1	P-44074	0088381974271	11,85
10	Industrial*	1	784830-A	0088381925419	15,95

Guia de aparafusamento

★★



Conteúdo	Comprimento (mm)	Un.	Código	EAN	P.V.P. (€)
Guia 80 mm	80	1	B-48751	0088381455756	4,80
Guia 120 mm	120	1	B-52934	0088381471312	5,40
Guia 120 mm	120	1	B-48767	0088381455763	5,95
Guia 80 mm 5 Ph2 5 Pz2 5 T20 5 T25 5 T30	80	1	B-48773	0088381455770	16,35
Guia 120 mm 5 Ph2 5 Pz2 5 T20 5 T25 5 T30	120	1	B-48789	0088381455787	16,35

Estojo de pontas (7 pç.)



★★

- Pontas 25 mm: PH1, PH2, SL3, SL5, PZ2 e PZ3.
- Compacto e ideal para o transporte.
- Conteúdo visível graças à tampa transparente.
- Porta-pontas magnético.

Conteúdo	Un.	Tipo	Código	EAN	P.V.P. (€)
7	1	**	D-73271	0088381582391	4,15

Embalagem de pontas magnéticas a granel

- 100 pontas duplas magnéticas.
- Disponíveis no tipo PH n.º 2 e PZ n.º 2.
- Inserção de 1/4" hexagonal indicada para para aparafusadoras de impacto e berbequins aparafusadores.
- Pontas duplas de 65 mm de comprimento.

★★★



Comprimento (mm)	Tipo	Un.	Código	EAN	P.V.P. (€)
65	Dupla PH2	1	D-31669	0088381356503	50,00
65	Dupla PZ2	1	D-34914	0088381367080	50,00

Frasco de pontas a granel

★★

- Disponíveis no tipo PH n.º 2 e PZ n.º 2 de 25 mm e 50 mm.
- Pontas magnéticas de 25 mm de comprimento.



Comprimento (mm)	Tipo	Un.	Código	EAN	P.V.P. (€)
25	PH2	1	B-24876	0088381409193	27,00
25	PZ2	1	B-24882	0088381409209	27,00
50	PH2	1	B-26490	0088381410229	26,00
50	PZ2	1	B-26509	0088381410236	26,00

Estojos de pontas

★★



Ponta	Un.	Código	EAN	P.V.P. (€)
31 peças por estojo: 1 x PH0, 1 x PH1, 4 x PH2, 1 x PH3 1 x PZ0, 1 x PZ1, 4 x PZ2, 1 x PZ3 1 x T10, 1 x T15, 2 x T20, 2 x T25, 1 x T27, 1 x T30, 1 x T40 1 x A3, 1 x A4, 1 x A5, 1 x A6 Planas: 4,5/5,5/6,5 Porta-pontas magnético	12	E-00022	0088381553155	220,00



★★

Ponta	Un.	Código	EAN	P.V.P. (€)
31 peças: 2 x Ph1, 4 x Ph2, 1 x Ph3 2 x Pz1, 5 x Pz2, 1 x Pz3 2 x T10, 2 x T15, 2 x T20 3x T25, 2 x T30, 1 x T40 4 5,5 6,5 mm Porta-pontas magnético	1	D-30667	0088381354295	11,35

Pontas duplas magnéticas

★★★

- Embalagem com dez pontas duplas com dispensador.
- 10 pontas duplas magnéticas.
- Inserção de 1/4" hexagonal indicada para para aparafusadoras de impacto e berbequins aparafusadores.
- Ponta dupla de 65 mm de comprimento.



Medida (mm)	Tipo de ponta	Un.	Código	EAN	P.V.P. (€)
65	Dupla PH2	1	D-34366	0088381365550	9,20

Estojo de pontas (11 pç.).

★★

- Porta-pontas magnético.
- Ponta PH2.
- Pontas PZ: PZ1, PZ2 e PZ3.
- Pontas em T: T10, T15, T20, T25, T30 e T40.



Medida (mm)	Conteúdo	Un.	Código	EAN	P.V.P. (€)
25	11 peças	1	D-64995	0088381533782	9,75

Estojo e pontas e caixas

★★★

- Pontas PZ: PZ1 x 2, PZ2 x 2, PZ3 x 2.
- Pontas PH: PH1 x 2, PH2 x 2, PH3 x 2.
- Pontas hexagonais: H2, H2,5, H3, H4 x 2, H5 x 2, H6 x 2.
- Pontas planas: SL4,5 x 2, SL5,5 x 2, SL6,5 x 2.
- Pontas em T: T10 x 2, T15 x 2, T20 x 2, T25 x 2, T30 x 2, T40
- Chaves de caixa: Hex5, Hex6, Hex7, Hex8 Hex9, Hex10, Hex10, Hex11.
- Porta-pontas magnético.
- Chave de fendas manual com roquete.



Conteúdo	Un.	Código	EAN	P.V.P. (€)
47 peças	1	B-36170	0088381433549	31,00

Estojo de pontas e chave de roquete

★★★

- Pontas PZ1, PZ2.
- Bits PH1, PH2, PH3.
- Pontas hexagonais H4, H6.
- Pontas planas SL0,8 x 5,5, SL1,2 x 6,5.
- Pontas em T T20, T25, T30.
- Chaves de caixa Hex5, Hex6, Hex8, Hex10, Hex12, Hex13.
- Ponta 1/4"Hex.
- Porta-pontas magnético
- Roquete.



Conteúdo	Un.	Código	EAN	P.V.P. (€)
21 peças	1	B-54081	0088381476966	34,00

Chaves de fendas

- Ideal para parafusos bem apertados que não podem ser desaparafusados com ferramentas elétricas ou que são muito difíceis de libertar com uma chave de fendas manual.
- Utiliza a força do impacto para gerar uma força oposta que acaba por desaparafusar o parafuso. Dispõe de uma mola no interior que, ao ser golpeada pelo martelo, comprime-se e liberta a referida força em forma de rotação.



Ponta	Comprimento (mm)	Un.	Código	EAN	P.V.P. (€)
PH2	125	1	B-42438	0088381440226	19,05
PZ2	125	1	B-42450	0088381440240	19,05

Estojos de pontas

★★

- Pontas PZ PZ0, PZ1, PZ2 x 2, PZ3.
- Pontas PH PH0, PH1, PH2 x 2, PH3.
- Pontas hexagonais H3, H4, H5, H6.
- Pontas planas SL4, SL4,5, SL5,5, SL6,5
- Pontas em T T10, T15, T20x2, T25 x 2, T27, T30 x 2, T40
- Pontas em T de segurança T10H, T15H, T20H, T25H, T27H, T30H, T40H.
- Porta-pontas magnético.



Conteúdo	Un.	Código	EAN	P.V.P. (€)
37 peças	1	B-28606	0088381414807	22,00

Estojo e pontas e caixas (30 pç.)

- Pontas de 25 mm PH, PZ, T, Hex e planas. ★★
- Pontas de 50 mm PH, PZ, T e planas.
- Porta-pontas magnético.
- Adaptador para caixas de 3/8".
- Caixas de 3/8" 63 mm: 17 e 19 mm.
- Caixas de 1/4" hex. magnéticas 8 e 10 mm.



Conteúdo	Un.	Código	EAN	P.V.P. (€)
30 peças	1	E-07060	0088381571265	31,00

Jogo de chaves, pontas e caixas de 221 peças

- Chave de roquete de 1/4" e 1/2". ★★
- Chave manual de 1/4".
- Extensões para caixas de 1/4" e caixas de 1/2".
- Adaptador 3 posições de 1/2" a 3/8".
- Rótulas de 1/4" e 1/2".
- Caixas de 1/4" 25 mm: 4, 4,5, 5, 5,5, 6, 7, 8, 9, 10, 11, 12, 13 e 14.
- Caixas de 1/2" 38 mm: 15, 16, 17, 19, 20, 21, 22, 24, 27, 30 e 32.
- Caixas estrela de 1/2" 38 mm: E10, E12, E14, E16, E18, E20 e E24.
- Caixas de 1/4" hex. de 38 mm: 5, 5,5, 6, 7, 8, 9, 10, 11, 12 e 13.
- Chaves fixas combinadas de 8 a 19 mm.
- Conjunto de chaves Allen de 1,5 a 8 mm.
- Cabo de chave de fendas.
- Pontas planas, PH, PZ, T, Hex...
- Porta-pontas magnético.



Conteúdo	Un.	Código	EAN	P.V.P. (€)
221 peças	1	E-10883	0088381581486	201,00

Mala de ferramentas manual de 120 peças

- Chave de roquete de 3/8".
- Caixas de 1/4" 25 mm: 4, 4,5, 5, 5,5, 6, 7, 8, 9, 10, 11, 12, 13 e 14 mm.
- Caixas de 3/8" 28 e 30 mm: 8, 9, 10, 11, 12, 13, 14, 15, 16, 17, 18, 19, 20 e 21 mm.
- Caixas estrela 1/4" 25 mm: E4, E5, E6, E7 e E8.
- Caixas estrela 3/8" 28 e 30 mm: E10, E11, E12, E14, E16 e E18.
- Caixas longas de 1/2" de 16 e 21 mm.
- Adaptadores 3/8", 1/4" e 1/2".
- Extensões para caixas de 1/4" e caixas de 3/8".
- Rótulas de 1/4" e 3/8".
- Chaves fixas combinadas de 8, 10, 11, 12, 13, 14 e 15 mm.
- Chave manual de 1/4".
- Porta-pontas magnético e guia de aparafusamento.
- Pontas planas, PH, PZ, T, Hex...



Conteúdo	Un.	Código	EAN	P.V.P. (€)
120 peças	1	E-06616	0088381570251	129,00



Mala de ferramentas manual (120 peças)

- Chave de roquete de 3/8".
- Chave de fendas manual de 1/4".
- Caixas de 3/8": 8 - 9 - 10 - 11 - 12 - 13 - 14 - 15 - 16 - 17 - 18 - 19 - 20 - 21 mm.
- Caixas de 1/4": 4 - 4,5 - 5 - 5,5 - 6 - 7 - 8 - 9 - 10 - 11 - 12 - 13 - 14 mm.
- Caixas de 1/4": E4 - E5 - E6 - E7 - E8. Caixas de 3/8": E10 - E11 - E12 - E14 - E16 - E18.
- Adaptador de 3/8" a 1/2" e duas caixas longas de 16 e 21 mm.
- Extensões de 3/8" de 75 e 150 mm.
- Extensões de 1/4" de 50 e 100 mm.
- Adaptadores móveis de 3/8" e 1/4".
- Porta-pontas e porta-pontas magnético.
- Pontas PH, PZ, T, TH, HH e planas.
- Chaves manuais 8 - 10 - 11 - 12 - 13 - 14 - 15 mm.
- Conjunto de chaves Allen 1,5 - 2 - 2,5 - 3 - 4 - 5 - 6 - 8 mm.

★★★★



Conteúdo	Un.	Código	EAN	P.V.P. (€)
120 peças	1	E-08713	0088381576727	140,00



Mala de ferramentas manual (87 peças)

- Chave de roquete de 1/2" 250 mm.
- Chave de roquete dupla de 1/4" e 3/8" 140 mm.
- Chave manual de 1/4" 152 mm.
- Chave inglesa de 150 mm.
- Alicates de 175 mm.
- Caixas longas de 1/2" 78 mm: 8, 10, 12, 13, 15, 17 e 19 mm.
- Caixas longas de 1/2" 65 mm: 16, 18 e 21 mm.
- Caixas de 1/4" 25 mm: 5, 6, 7, 8, 9, 10, 11, 12 e 13 mm.
- Adaptador 1/4" hex.
- Porta-pontas 1/4" hex. 60 mm
- Porta-pontas magnético 1/4" hex. 60 mm
- Conjunto de chaves Allen 1,5, 2, 2,5, 3, 4, 5, 6 e 8 mm.
- Adaptador de 1/2" a 3/8".
- Adaptador de 1/4" a 1/4" hex.
- Chaves fixas combinadas: 10, 12, 13, 14 e 17 mm.
- Chaves de fendas PZ2, SL1,0, PH1 e PH2.
- Chave de fendas para carburador de 115 mm.
- Pontas PH: PH1, PH2 e PH3.
- Pontas PZ: PZ1, PZ2 e PZ3.
- Pontas planas: SL0,5 x 3,0, SL0,8 x 4,0 e SL0,8 x 5,0.
- Pontas em T: T9, T10, T15, T20, T25, T27, T30, T35 e T40.
- Pontas TH: T10H, T15 H, T20H, T25H, T27H, T30H, T35H e T40H.
- Pontas hex.: HEX3, HEX4, HEX5 e HEX6.

★★★★



Conteúdo	Un.	Código	EAN	P.V.P. (€)
87 peças	1	E-11542	0088381583466	162,00

Jogos de ferramentas manuais (87 peças)

★★★

- Chave de roquete de 1/2".
- Chave de roquete com inserção dupla de 1/4" e 3/8".
- Chave porta-pontas manual de 152 mm.
- Chave inglesa de 150 mm.
- Alicates de 150 mm.
- Chaves combinadas manuais 10 - 12 - 13 - 14 - 17 mm.
- Conjunto de chaves Allen 1,5 - 2 - 2,5 - 3 - 4 - 5 - 6 - 8 mm.
- Chaves de fenda manuais PH1, PH2, PZ2 e planas 1,0 - 6,0.
- Chave de fendas para carburadores.
- Caixas de 1/4": 5 - 6 - 7 - 8 - 9 - 10 - 11 - 12 - 13 mm.
- Caixas longas de 1/2": 8 - 10 - 12 - 13 - 15 - 17 - 19 mm.
- Porta-pontas e porta-pontas magnético.
- Pontas PH, PZ, T e TH.
- Adaptador de 1/4".



Jogo de ferramentas manuais (76 peças)

★★★

- Chave de roquete de 3/8"
- Chave de fendas para pontas de 1/4"
- Cortador
- Chave de fendas para caixas de 1/4"
- Martelo de 180 mm
- Alicates de 150 mm.
- Alicates de ponta fina de 150 mm
- Caixas longas de 3/8": 8 mm - 9 mm - 10 mm - 11 mm - 12 mm - 13 mm - 14 mm - 15 mm - 16 mm - 17 mm - 18 mm - 19 mm - 20 mm - 21 mm
- Caixas de 1/4": 4 - 5 - 6 - 7 - 8
- Porta-pontas magnético.
- Jogo de chaves de caixa de 1/4": 5 - 6 - 7 - 8 - 9 - 10 - 11
- Adaptador de caixa de 1/2" 1/4" - 3/8"
- Pontas de 25 mm 1/4": PH1 - PH2 - PH3 - T8 - T9 - T10 - T15 - T20 - T25 - T27 - T30 - T40 - T8H - T10H - T15H - T20H - T25H - T27H - T30H - T40H - SL 0,5 X 3,0 - SL 0,8 X 4,0 - SL 0,8 X 5,0 - SL 1,0 X 5,5 - SL 1,0 X 6,0
- Extensores para caixas de 3/8" 75 mm 150 mm
- Rótulas de 1/4" e 3/8".



Conteúdo	Un.	Código	EAN	P.V.P. (€)
87 peças	1	E-08458	0088381575638	152,00

Conteúdo	Un.	Código	EAN	P.V.P. (€)
76 peças	1	E-10899	0088381581493	102,00



Caixas para chaves de impacto



*Não inclui cavilha nem arruela de borracha.



Inserção	Métrica	Ø int. (mm)	Ø ext. (mm)	Compr. (mm)	Código	EAN	P.V.P. (€)
3/8"	-	6	11	28	B-39883	0088381436595	3,55
3/8"	-	7	12	28	B-39899	0088381436601	3,55
3/8"	-	8	13	28	B-39908	0088381436618	3,55
3/8"	-	9	14	28	B-39914	0088381436625	3,55
3/8"	-	10	15	28	B-39920	0088381436632	3,55
3/8"	-	11	18	28	B-39936	0088381436649	3,55
3/8"	M7	12	18	28	B-39942	0088381436656	3,50
3/8"	M8	13	20	28	B-39958	0088381436663	4,10
3/8"	M8	14	20	28	B-39964	0088381436670	4,10
3/8"	-	15	22	28	B-39970	0088381436687	4,35
3/8"	-	16	24	28	B-39986	0088381436694	4,35
3/8"	M10	17	24	28	B-39992	0088381436700	4,35
3/8"	-	18	28	28	B-40004	0088381436717	4,90

Tipo	Inserção	Métrica	Ø int. (mm)	Ø ext. (mm)	Compr. (mm)	Código	EAN	P.V.P. (€)	
D	3	3/4"	M10	17	28	50	A-85494	0088381158817	9,80
E	4	3/4"	M10	17	31	95	A-85503	0088381158824	19,55
D	3	3/4"	M12	19	30	50	A-85519	0088381158831	10,30
E	4	3/4"	M12	19	33	95	A-85525	0088381158848	19,55
D	3	3/4"	M14	21	32	52	A-85531	0088381158855	10,30
E	4	3/4"	M14	21	35	95	A-85547	0088381158862	19,55
D	3	3/4"	M14	22	34	52	A-85553	0088381158879	10,30
E	4	3/4"	M14	22	37	95	A-85569	0088381158886	19,55
D	3	3/4"	M16	24	36	52	A-85575	0088381158893	10,30
E	4	3/4"	M16	24	39	95	A-85581	0088381158909	18,55
D	3	3/4"	M16	26	38	52	134853-6	0088381149105	11,35
E	4	3/4"	M16	26	44	95	134854-4	0088381149112	23,00
D	3	3/4"	M18	27	38	52	134855-2	0088381149129	10,30
E	4	3/4"	M18	27	44	95	134856-0	0088381149136	21,00
		3/4"	M20	30	44	52	134857-8	0088381149143	10,30
		3/4"	M20	30	44	95	134858-6	0088381149150	18,00
F	5	3/4"	M22	32	44	52	134871-4	0088381149167	10,30
		3/4"	M22	32	44	95	134859-4	0088381149174	18,55
		3/4"	M22	35	44	56	134860-9	0088381149181	13,40
		3/4"	M22	35	44	95	134861-7	0088381149198	25,00
		3/4"	M24	36	44	56	134862-5	0088381149204	14,95
		3/4"	M24	36	44	95	134863-3	0088381149211	22,00

Tipo	Inserção	Métrica	Ø int. (mm)	Ø ext. (mm)	Compr. (mm)	Código	EAN	P.V.P. (€)	
A	1	1/2"	M7	12	19	38	A-89931	0088381185882	4,10
		1/2"	M7	12	25	75	134867-5	0088381152488	33,00
		1/2"	M8	13	25	38	134825-1	0088381148948	4,90
		1/2"	M8	13	26	52	134827-7	0088381148955	6,45
		1/2"	M8	14	25	38	134826-9	0088381160704	4,90
		1/2"	M8	14	25	52	134828-5	0088381170178	5,15
		1/2"	-	16	25	38	B-10506	0088381343299	4,90
		1/2"	M10	17	26	38	134829-3	0088381148962	4,90
		1/2"	M10	17	26	52	134830-8	0088381148979	4,90
		B	1	1/2"	M12	19	28	38	134831-6
1/2"	M12			19	28	52	134832-4	0088381148993	5,65
C	1	1/2"	M12	19	30	78	134837-4	0088381161824	8,00
		1/2"	M14	21	30	38	134838-2	0088381161787	6,20
B	1	1/2"	M14	21	28	52	134833-2	0088381161794	7,20
C	1	1/2"	M14	21	30	78	134839-0	0088381161831	8,75
B	1	1/2"	M14	22	30	38	134851-0	0088381149006	6,45
C	1	1/2"	M14	22	28	52	134834-0	0088381149013	7,20
C	1	1/2"	M14	23	30	38	134840-5	0088381161800	6,45
B	2	1/2"	M14	23	28	52	134835-8	0088381170499	7,70
C	2	1/2"	M16	24	30	45	134841-3	0088381149020	7,70
B	2	1/2"	M16	24	28	52	134836-6	0088381149037	8,00
C	2	1/2"	M16	26	30	50	134842-1	0088381161770	8,50
		1/2"	M16	26	30	75	134843-9	0088381161817	10,80
		1/2"	M18	27	30	50	134844-7	0088381149044	7,70
		1/2"	M18	27	30	78	134845-5	0088381149051	11,85
		1/2"	M20	30	30	50	134846-3	0088381149068	9,25
		1/2"	M20	30	30	78	134847-1	0088381149075	12,35
		1/2"	M22	32	30	50	134848-9	0088381149082	9,00
		1/2"	M22	32	30	78	134849-7	0088381149099	12,90

Tipo	Inserção	Métrica	Ø int. (mm)	Ø ext. (mm)	Compr. (mm)	Código	EAN	P.V.P. (€)	
F	5	1"	M22	35	52	80	134864-1	0088381200882	23,00
		1"	M24	36	52	80	134865-9	0088381200899	22,00
		1"	M27	41	52	80	134872-2	0088381200011	24,00

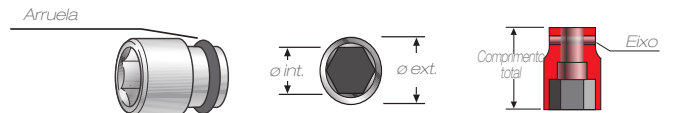

Anel de borracha - Cavilha



Tipo	Código	EAN	P.V.P. (€)	Tipo	Código	EAN	P.V.P. (€)
A	213397-0	-	1,00	1	268056-1	-	1,00
B	213398-8	0088381155496	1,00	2	268057-9	0088381162708	1,00
C	213399-6	0088381495240	1,00	3	256283-2	-	1,00
D	213461-7	3240890114174	1,00	4	256282-4	0088381495431	1,00
E	213514-2	0088381495264	1,00	5	256284-0	0088381200035	1,90
F	213570-2	0088381200028	1,00				

Estojo de chaves de caixa de 9 peças

- Estojo de 9 peças com espuma interior para uma boa conservação das caixas.
- Prático estojo de plástico com fecho e logótipo Makita.
- Cada caixa está equipada com a sua própria borracha e cavilha, para uma fixação perfeita à máquina.
- Estas caixas são especialmente concebidas para trabalhar com ferramentas elétricas ou pneumáticas.
- Informação sobre a composição: CR-MO (Crómio - molibdénio)
- CR-MO: para ferramentas elétricas



★★★

Inserção	Ø int. (mm)	Ø ext. (mm)	Compr. (mm)	Código	EAN	P.V.P. (€)
1/2"	8	15	38	D-41517	0088381404334	54,00
1/2"	10	17,5	38			
1/2"	13	20	38			
1/2"	16	24	38			
1/2"	17	26	38			
1/2"	18	28	38			
1/2"	19	28	38			
1/2"	21	30	38			
1/2"	24	34	38			

Jogo de chaves de caixa para automóvel

★★★



Inserção	Ø int. (mm)	Ø ext. (mm)	Compr. (mm)	Código	EAN	P.V.P. (€)
1/2"	3	17	86	E-12354	0088381586528	31,00
1/2"		19				
1/2"		21				

Adaptadores de inserção para DWR180 e WR100D



Modelos	Un.	Código	EAN	P.V.P. (€)
Para caixas de 3/8"	1	191A50-3	0088381546744	20,10
Para caixas de 1/4"	1	191A51-1	0088381546737	20,10

Batente de profundidade para aparafusadoras de impacto



Modelos	Un.	Código	EAN	P.V.P. (€)
TD0101F DTD145 DTD146	1	194281-7	0088381276108	28,00

Acessórios para DTL061



134745-9

192439-2

192440-7

Descrição	Un.	Código	EAN	P.V.P. (€)
Adaptador de 3/8"	1	134745-9	0088381134361	19,00
Adaptador de 1/2"	1	134746-7	0088381142632	18,55
Cabeça de roquete	1	192439-2	0088381128742	154,00
Cabeça reta	1	192440-7	0088381128759	69,00

Extensão



Inserção	Comprimento (mm)	Un.	Código	EAN	P.V.P. (€)
1/2"	100	1	134874-8	0088381149228	23,00
3/4"	150	1	134997-2	0088381194730	49,00
1"	200	1	134870-6	0088381150200	67,00

Rótula



Inserção	Comprimento (mm)	Un.	Código	EAN	P.V.P. (€)
1/2"	80	1	134877-2	0088381149242	66,00
3/4"	105,5	1	134998-0	0088381206891	100,00

Adaptadores de inserção



P-05941

P-05963

B-68448

Inserção	Saída	Comprimento (mm)	Un.	Código	EAN	P.V.P. (€)
1/2"	1/4"	47	1	P-05941	0088381946681	43,00
3/8"	1/4"	37	1	P-05963	0088381946704	37,00
1/2"	1/4"	47	1	B-68448	0088381546287	16,20

★★★★

★★★★

★★★

Gancho para cinturão



Modelos	Un.	Código	EAN	P.V.P. (€)
DTD129 DTD148 DTD154 DTD170 DTD171	1	197043-2	0088381447362	30,00

Cabo de extensão



Modelo	Comprimento (mm)	Un.	Código	EAN	P.V.P. (€)
6844 6842 DFR440 DFR550	890 - 990	1	194500-1	0088381342377	83,00

Cabo de extensão



Modelo	Medidas (mm)	Un.	Código	EAN	P.V.P. (€)
DTW1001 DTW1002 DTW700 DTW701 TW001G	807 - 657 x 243 x 172 mm	1	191G67-2	0088381568302	129,00

Porta-brocas automático - 1/4" hexagonal



763198-1



784643-3

Inserção	Capacidade (mm)	Passo	Tipo	Código	EAN	P.V.P. (€)
1/4" hex	1,0 - 10	3/8"	Automático	763198-1	0088381256070	26,00
Adaptador	1/2"	3/8"	-	784643-3	0088381248013	4,65

Cabo conector



Modelos	Compr. (mm)	Qualidade	Un.	Código	EAN	P.V.P. (€)
FS6300R	4	Padrão	1	699020-5	3240890265913	12,55
	10	Padrão	1	194330-0	0088381289863	24,00
	10	Alta	1	194906-3	0088381354066	37,00

Anel de bloqueio para bocas de aparafusamento*



*necessário para todas as bocas de aparafusamento, exceto as caixas para FS2700

Un.	Código	EAN	P.V.P. (€)
1	455591-0	-	1,75

Punho auxiliar



Modelo	Comprimento (mm)	Un.	Código	EAN	P.V.P. (€)
6906	110	1	122464-9	0088381152495	17,50
TW1000	110	1	122727-3	0088381199988	21,00

Bocas de aparafusamento



Modelos	Para	Medida	Un.	Código	EAN	P.V.P. (€)
FS2500	Caixa	1/4"	1	450963-4	0088381365093	1,80
		5/16"	1	450967-6	0088381468633	1,20
		3/8"	1	450968-4	0088381365109	1,20
	Ponta	60 mm	1	122867-7	3240890367600	6,10
		75 mm	1	122868-5	-	6,75
FS2300 FS4200 FS6300R	Ponta	60 mm	1	158875-2	3240890322227	6,70
		75 mm	1	158876-0	0088381468558	7,25
FS2700	Pontas 50 mm	-	1	322120-3	0088381162753	8,00
		1/4"	1	322124-5	3240890027573	12,35
	Pontas	5/16"	1	322125-3	-	12,90
		3/8"	1	322119-8	3240890083586	18,55
	Caixa	7/16"	1	322126-1	-	13,90



Limpar e Lixar



Catrabuchas para berbequins



Catrabuchas

Material



Arame de aço ondulado

- Recomendado para remover ferrugem, vernizes, esmaltes... de superfícies metálicas.



Nylon grosso

- Perfeito para limpar ferrugem, verniz, esmalte... de superfícies de metal, madeira e PVC.



Nylon fino

- Para um acabamento mais suave.
- Adequado para madeira, metal e PVC.

Forma



Escovas de acabamento

- Perfeitas para superfícies estreitas ou de difícil acesso.



Copo ondulado

- Ideal para a limpeza de superfícies planas ou rugosas.

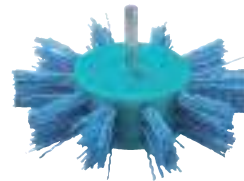

Escovas de cerdas

- Para superfícies planas.
- Recomendadas para madeira.



Escova oblíqua

- Ideal para limpeza de superfícies estreitas, bordas ou ranhuras.



Arame entrançado



Arame



Arame latonado



Nylon grosso G80



Nylon fino G240

	Arame entrançado	Arame	Arame latonado	Nylon grosso G80	Nylon fino G240
Indicado para	Ideal para metal e trabalhos pesados	Ideal para metal e trabalhos leves	Ideal para metal e madeira. Arame resistente à oxidação.	Ideal para a ferrugem ligeira de metal, madeira e PVC.	Ideal para o acabamento de materiais, madeira e PVC.
Eficiência	Eficiência muito alta	Eficiência alta	Eficiência alta	Eficiência baixa	Eficiência muito baixa
Acabamento	Muito grosseiro	Grosseiro	Grosseiro	Limpo	Muito limpo
Madeira	X	X	✓	✓	✓
PVC	X	X	◆	✓	✓
Metal	✓	✓	✓	✓	✓

✓ : Recomendado ◆ : Válido X : Não recomendado

Catrabuchas para berbequins

Escovas de acabamento de nylon



- Ideal para superfícies estreitas ou de difícil acesso. Remoção de ferrugem, esmaltes, vernizes, etc., em metais, plásticos ou madeira.



Ø (mm)	Inserção (mm)	Grão	Espessura (mm)	Tipo	Un.	Código	EAN	P.V.P. (€)
12	6	80	1,4	Nylon	1	D-45668	0088381408875	3,00
17	6	80	1,4	Nylon	1	D-45674	0088381408882	3,80
24	6	80	1,4	Nylon	1	D-45680	0088381408899	4,35
30	6	80	1,4	Nylon	1	D-45696	0088381408905	6,00
12	6	240	0,7	Nylon	1	D-45705	0088381408912	3,00
17	6	240	0,7	Nylon	1	D-45711	0088381408929	3,80
24	6	240	0,7	Nylon	1	D-45727	0088381408936	4,35
30	6	240	0,7	Nylon	1	D-45733	0088381408943	6,00

Escovas de acabamento de arame



- Muito eficazes para superfícies estreitas e de difícil acesso. Arames ondulados para tornar a superfície acabada muito mais lisa.



Ø (mm)	Inserção (mm)	Grão	Espessura (mm)	Tipo	Un.	Código	EAN	P.V.P. (€)
12	6	-	-	Arame	1	D-40004	0088381400121	1,65
19	6	-	-	Arame	1	D-40010	0088381400138	1,90
25	6	-	-	Arame	1	D-40026	0088381400145	2,45
30	6	-	-	Arame	1	D-40032	0088381400152	2,70

Escovas de acabamento de arame latonado



- Ideais para trabalhar em superfícies estreitas e de difícil acesso.
- Mais macias, ideais para madeira.



D-73710

D-73726

D-73732

Ø (mm)	Inserção (mm)	Grão	Espessura (mm)	Tipo	Un.	Código	EAN	P.V.P. (€)
12	6	-	-	Latonado	1	D-73704	0088381586238	1,35
19	6	-	-	Latonado	1	D-73710	0088381586245	1,55
24	6	-	-	Latonado	1	D-73726	0088381586252	1,85
28	6	-	-	Latonado	1	D-73732	0088381586269	2,10

Escovas de arame entrançado



- Ideais para superfícies estreitas e de difícil acesso. Indicadas para metal.
- Arame de aço mais grosso para trabalhos mais exigentes.



D-73835

D-73841

D-73863

Ø (mm)	Inserção (mm)	Grão	Espessura (mm)	Tipo	Un.	Código	EAN	P.V.P. (€)
12	6	-	-	Entrançado	1	D-73835	0088381586467	2,25
19	6	-	-	Entrançado	1	D-73841	0088381586474	2,90
24	6	-	-	Entrançado	1	D-73857	0088381586481	3,40
28	6	-	-	Entrançado	1	D-73863	0088381586498	4,45



Catrabuchas para berbequins

Escovas de copo ondulado de nylon



- Ideais para a limpeza de superfícies planas ou rugosas. Remoção de ferrugem, esmaltes, vernizes, etc., em metais, plásticos e madeira.



Ø (mm)	Inserção (mm)	Grão	Espessura (mm)	Tipo	Un.	Código	EAN	P.V.P. (€)
50	6	80	1,4	Nylon	1	D-45509	0088381408714	4,90
63	6	80	1,4	Nylon	1	D-45515	0088381408721	6,55
75	6	80	1,4	Nylon	1	D-45521	0088381408738	7,60
50	6	240	0,7	Nylon	1	D-45537	0088381408745	4,90
63	6	240	0,7	Nylon	1	D-45543	0088381408752	6,55
75	6	240	0,7	Nylon	1	D-45559	0088381408769	7,60

Escovas de copo ondulado de arame



- Muito eficazes em superfícies planas ou rugosas. Arames ondulados para tornar a superfície acabada muito mais lisa.



Ø (mm)	Inserção (mm)	Grão	Espessura (mm)	Tipo	Un.	Código	EAN	P.V.P. (€)
38	6	-	-	Arame	1	D-39908	0088381400022	1,95
50	6	-	-	Arame	1	D-39914	0088381400039	2,20
63	6	-	-	Arame	1	D-39920	0088381400046	2,45
75	6	-	-	Arame	1	D-39936	0088381400053	2,70
80	6	-	-	Arame	1	D-39942	0088381400060	3,25

Catrabuchas de copo ondulado de arame latonado



- Muito eficazes para superfícies planas. Adequadas para a remoção de ferrugem, vernizes, etc. Especialmente recomendadas para madeira.



D-73601

D-73623

D-73645

Ø (mm)	Inserção (mm)	Grão	Espessura (mm)	Tipo	Un.	Código	EAN	P.V.P. (€)
	6	-	-	Latonado	1	D-73601	0088381586139	1,45
50	6	-	-	Latonado	1	D-73617	0088381586146	1,70
63	6	-	-	Latonado	1	D-73623	0088381586153	1,85
75	6	-	-	Latonado	1	D-73639	0088381586160	2,10
80	6	-	-	Latonado	1	D-73645	0088381586177	2,60

Escovas de copo ondulado de arame entrançado



- Muito eficazes para superfícies planas. Adequadas para a remoção de ferrugem, vernizes, etc. Especialmente recomendadas para superfícies metálicas.



D-73798

D-73807

Ø (mm)	Inserção (mm)	Grão	Espessura (mm)	Tipo	Un.	Código	EAN	P.V.P. (€)
63	6	-	-	Entrançado	1	D-73798	0088381586429	4,65
75	6	-	-	Entrançado	1	D-73807	0088381586436	5,15

Escovas de cerdas de nylon



- Ideais para superfícies planas. Remoção de ferrugem, limpeza de áreas de soldadura, vernizes, etc.

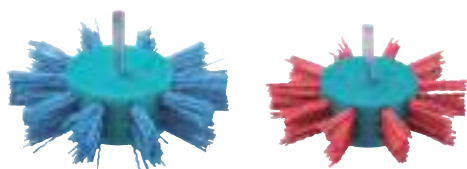

Ø (mm)	Inserção (mm)	Grão	Espessura (mm)	Tipo	Un.	Código	EAN	P.V.P. (€)
100	6	80	1,4	Nylon	1	D-45749	0088381408950	8,20
100	6	240	0,7	Nylon	1	D-45755	0088381408967	8,20

Catrabuchas para berbequins

Escovas oblíquas de nylon



- Ideais para a limpeza de superfícies estreitas, bordas ou ranhuras. Remoção de ferrugem, esmaltes, vernizes, etc., em metais, plásticos e madeira.



Ø (mm)	Inserção (mm)	Grão	Espessura (mm)	Tipo	Un.	Código	EAN	P.V.P. (€)
38	6	80	1,4	Nylon	1	D-45565	0088381408776	3,85
50	6	80	1,4	Nylon	1	D-45571	0088381408783	4,65
63	6	80	1,4	Nylon	1	D-45587	0088381408790	4,90
75	6	80	1,4	Nylon	1	D-45593	0088381408806	6,55
100	6	80	1,4	Nylon	1	D-45602	0088381408813	7,60
38	6	240	0,7	Nylon	1	D-45618	0088381408820	3,85
50	6	240	0,7	Nylon	1	D-45624	0088381408837	4,65
63	6	240	0,7	Nylon	1	D-45630	0088381408844	4,90
75	6	240	0,7	Nylon	1	D-45646	0088381408851	6,55
100	6	240	0,7	Nylon	1	D-45652	0088381408868	7,60

Escovas oblíquas de arame



- Muito eficazes para remover as rebarbas e a ferrugem em trabalhos finos.
- Arames ondulados para tornar a superfície acabada muito mais lisa.



Ø (mm)	Inserção (mm)	Grão	Espessura (mm)	Tipo	Un.	Código	EAN	P.V.P. (€)
38	6	-	5	Arame	1	D-39958	0088381400077	1,90
50	6	-	7	Arame	1	D-39964	0088381400084	2,20
63	6	-	9	Arame	1	D-39970	0088381400091	2,45
75	6	-	10	Arame	1	D-39986	0088381400107	2,75
100	6	-	12	Arame	1	D-39992	0088381400114	3,00

Escovas oblíquas de arame latonado



- Muitos eficazes para lixar ranhuras, especialmente em madeira.



D-73651

D-73673

D-73695

Ø (mm)	Inserção (mm)	Grão	Espessura (mm)	Tipo	Un.	Código	EAN	P.V.P. (€)
38	6	-	5	Latonado	1	D-73651	0088381586184	1,45
50	6	-	7	Latonado	1	D-73667	0088381586191	1,55
63	6	-	9	Latonado	1	D-73673	0088381586207	1,75
75	6	-	10	Latonado	1	D-73689	0088381586214	1,85
100	6	-	12	Latonado	1	D-73695	0088381586221	2,10

Escovas oblíquas de arame lentrançado



- Ideais para superfícies estreitas e ranhuras principalmente de metal.



D-73813

Ø (mm)	Inserção (mm)	Grão	Espessura (mm)	Tipo	Un.	Código	EAN	P.V.P. (€)
75	6	-	-	Entrançado	1	D-73813	0088381586443	4,45
100	6	-	-	Entrançado	1	D-73829	0088381586450	4,65

Jogo de catrabuchas de nylon para berbequins

GROSSA (vermelho) e FINA (azul)



- Inclui copo ondulado de 50 mm, escova oblíqua de 50 mm e escova de acabamento de 24 mm.



Ø (mm)	Inserção (mm)	Grão	Espessura (mm)	Tipo	Un.	Código	EAN	P.V.P. (€)
50	6	80	1,4	Nylon	1	D-70742	0088381556033	10,35
50	6	80	1,4	Nylon	1			
24	6	80	1,4	Nylon	1			

Ø (mm)	Inserção (mm)	Grão	Espessura (mm)	Tipo	Un.	Código	EAN	P.V.P. (€)
50	6	240	0,7	Nylon	1	D-70758	0088381556040	10,35
50	6	240	0,7	Nylon	1			
24	6	240	0,7	Nylon	1			

Catrabuchas para rebarbadoras

- Para a limpeza antes da soldadura, oxidação e limpeza de tinta, salpicos de soldadura. Remoção da corrosão da rebarbagem, limpeza de barcos, tanques de aço, preparação de superfícies metálicas antes de pintar..



Makita

Forma



Copo ondulado

- Recomendado para remover ferrugem, vernizes, esmaltes... de superfícies metálicas.



Copo ondulado entrançado

- Arame de aço mais grosso para trabalhos mais exigentes que o tipo ondulado.
- Para superfícies mais amplas que o tipo reto.



Copo reto ondulado entrançado

- Para um acabamento mais suave
- Adequado para madeira, metal e PVC.



Escova oblíqua frisada

- Recomendada para remover ferrugem, verniz, esmalte... de superfícies metálicas em cantos ou lugares estreitos.



Escova oblíqua trançada

- Arame de aço mais grosso para trabalhos mais exigentes que o tipo oblíquo frisado.

Aplicação					
Madeira	X	X	◆	X	X
PVC	X	X	◆	X	X
Metal	✓	✓	✓	✓	✓

✓ : Recomendado

◆ : Válido

X: Não recomendado

Catrabuchas para rebarbadoras de aço

Copo ondulado de arame



- Para superfícies planas ou rugosas. Arames ondulados para tornar a superfície acabada muito mais lisa.



Ø (mm)	Inserção (mm)	Espessura (mm)	Tipo	Un.	Código	EAN	P.V.P. (€)
60	M14	0,3	Aço	1	D-24072	0088381313674	3,80
75	M14	0,3	Aço	1	D-24094	0088381313698	4,35
100	M14	0,3	Aço	1	D-29284	0088381345835	6,25
60	M14	0,3	Aço latonado	1	D-39746	0088381399869	3,85
75	M14	0,3	Aço latonado	1	D-39768	0088381399883	4,35
90	M14	0,3	Aço latonado	1	D-39780	0088381399906	5,45
100	M14	0,3	Aço latonado	1	D-39805	0088381399920	7,10

Copo ondulado de arame entrançado



- Para superfícies planas ou rugosas. Arame de aço mais grosso que o tipo ondulado para trabalhos mais exigentes.



Ø (mm)	Inserção (mm)	Espessura (mm)	Tipo	Un.	Código	EAN	P.V.P. (€)
60	M14	0,5	Aço	1	D-24119	0088381313711	5,20
75	M14	0,5	Aço	1	D-24131	0088381313735	5,75

Copo reto ondulado entrançado



- Para superfícies planas ou rugosas. Arame de aço mais grosso que o tipo ondulado para trabalhos mais exigentes.



Ø (mm)	Inserção (mm)	Espessura (mm)	Tipo	Un.	Código	EAN	P.V.P. (€)
60	M14	0,5	Aço	1	D-24153	0088381313759	6,55
100	M14	0,5	Aço	1	D-29290	0088381345842	9,55

Escova oblíqua de arame frisado



- Muito útil para limpar cantos ou lugares estreitos onde os utilizadores não conseguem chegar facilmente. Arames oblíquos para tornar a superfície acabada muito mais lisa.



Ø (mm)	Inserção (mm)	Espessura (mm)	Tipo	Un.	Código	EAN	P.V.P. (€)
100	M14	0,3	Aço	1	D-39827	0088381399944	4,60
115	M14	0,3	Aço	1	D-39849	0088381399968	5,45

Escova oblíqua de arame trançado



- Muito útil para limpar cantos ou lugares estreitos onde os utilizadores não conseguem chegar facilmente. Arames oblíquos para tornar a superfície acabada muito mais lisa.



Ø (mm)	Inserção (mm)	Espessura (mm)	Tipo	Un.	Código	EAN	P.V.P. (€)
100	M14	0,5	Aço	1	D-39861	0088381399982	5,20
115	M14	0,5	Aço	1	D-39883	0088381400008	5,45
115	M14	0,5	Aço	1	D-29561	0088381346726	6,00
125	M14	0,5	Aço	1	D-29577	0088381346733	7,90
150	M14	0,5	Aço	1	D-45761	0088381410328	10,35
175	M14	0,5	Aço	1	D-45777	0088381410335	13,10

Rolos para N9741**Rolo de arame de aço latonado**

- Ideal para madeiras com veios, duras e macias. Adequado para a abrasão forte de madeiras macias e duras. Para a remoção de ferrugem e limpeza.

Tipo	Un.	Código	EAN	P.V.P. (€)
Aço latonado	1	P-65648	0088381996167	105,00

Rolo de cerdas de aço

- Para a remoção de ferrugem. Remoção de verniz. Limpeza de peças de cofragem de betão.

Tipo	Un.	Código	EAN	P.V.P. (€)
Aço	1	P-04400	0088381914246	108,00

Rolo de cerdas de fibra

- Para aplicação de nogalina e verniz e posterior polimento, bem como abrihantamento natural de madeira.

Tipo	Un.	Código	EAN	P.V.P. (€)
Fibra	1	P-04416	0088381914253	87,00

Rolo de polimento de algodão

- Para polir superfícies, mesmo com os correspondentes cremes de polimento para aço inoxidável, latão, etc.

Tipo	Un.	Código	EAN	P.V.P. (€)
Algodão	1	794381-9	0088381139885	194,00

Rolo de nylon

- Para a estruturar madeira macia e retocar madeira dura estruturada. Para destacar a estrutura da madeira e remover possíveis fibras de madeira. Para o pré-tratamento ideal da superfície antes da aplicação posterior de verniz e nogalina. Para realizar uma superfície retificada em aço inoxidável e alumínio.

Grão	Tipo	Un.	Código	EAN	P.V.P. (€)
60	Nylon	1	P-04422	0088381914260	103,00
80	Nylon	1	P-04438	0088381914277	104,00
80	Nylon	1	794384-3	0088381139915	164,00
100	Nylon	1	794379-6	0088381140232	153,00
120	Nylon	1	P-04444	0088381914284	104,00
180	Nylon	1	P-04450	0088381914291	104,00
240	Nylon	1	794383-5	0088381139908	156,00
320	Nylon	1	P-04466	0088381914307	103,00



Rolo abrasivo



- Para o polimento de superfícies metálicas planas. Altamente recomendado para aço inoxidável.

Grão	Tipo	Un.	Código	EAN	P.V.P. (€)
80	Abrasivo	1	P-18035	0088381944410	58,00
120	Abrasivo	1	P-18041	0088381944427	58,00
180	Abrasivo	1	P-18029	0088381944403	58,00

Rolo abrasivo com lixas



- Para o polimento de superfícies metálicas planas. Altamente recomendado para aço inoxidável. Lixa e pule ao mesmo tempo.

Grão	Tipo	Un.	Código	EAN	P.V.P. (€)
80	Abrasivo	1	P-18057	0088381944434	64,00
120	Abrasivo	1	P-19233	0088381945844	64,00
180	Abrasivo	1	P-19249	0088381945851	64,00

Rolo de lixas



- Para polir superfícies. Raspar tinta.

Grão	Tipo	Un.	Código	EAN	P.V.P. (€)
40	Abrasivo	1	P-01127	0088381913904	61,00
80	Abrasivo	1	P-01155	0088381921596	61,00



Lâminas HM e HSS ★★

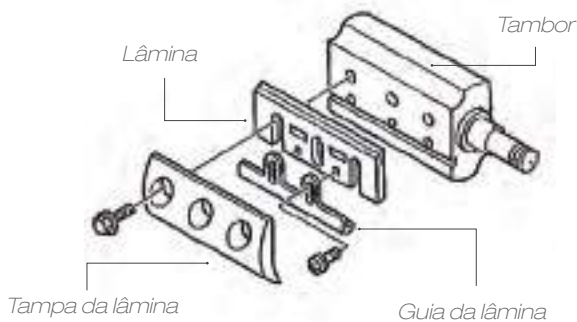

Modelo	Tipo	Comprimento (mm)	Un.	Código	EAN	P.V.P. (€)
1100 DKP180 DKP181 KP0800 KP0810 KP0810C	HSS	82	2	D-16346	0088381187756	6,80
	HM	82	2	D-07967	0088381181624	14,70
1911B	HSS	110	2	D-71211	0088381560160	14,30
	HSS	170	2	D-63666	0088381524070	25,00



Conjunto de mini lâminas + lâminas HM/chapas ★★

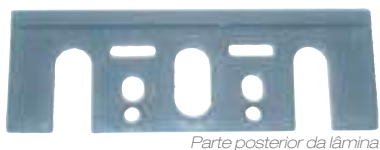

Parte posterior da lâmina

Modelos	Comprimento (mm)	Detalhe	Un.	Código	EAN	P.V.P. (€)
1100 DKP180 DKP181 KP0800 KP0810 KP0810C	82	2+2	1	D-07951	0088381181617	12,45

Chapa para mini lâminas



Modelos	Comprimento (mm)	Un.	Código	EAN	P.V.P. (€)
1100 DKP180 DKP181 KP0800 KP0810 KP0810C	82	1	343433-9	0088381151115	3,60

Mini lâminas

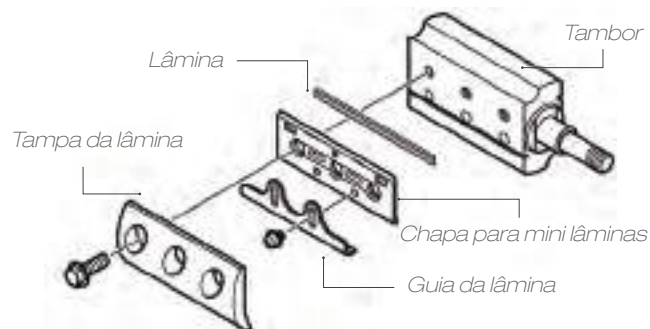

Modelo	Tipo	Comprimento (mm)	Un.	Código	EAN	P.V.P. (€)	
1050D 1051D	HM	50	2	A-85400	0088381148337	10,30	★★★
1100 DKP180 DKP181 KP0800 KP0810 KP0810C	HM	82	2	D-07945	0088381181600	11,10	★★
KP301	HSS	300	12	P-19831	0088381946445	139,00	★★★
2012NB	HSS	304	2	793346-8	0088381101042	39,00	★★★
KP312S	HSS	312	2	B-02870	0088381125840	36,00	★★★

Jogo de mini lâminas de 82 mm ★★

- Embalagem com 5 pacotes de 2 unidades de mini lâminas código D-07945. Os jogos podem ser facilmente separados para a venda individual de cada um deles.
- Adequado para plainas de 82 mm.



Comprimento (mm)	Tipo	Un.	Código	EAN	P.V.P. (€)
82	HM	5	D-35302	0088381367646	41,00

Guias paralelas



Tipo A



Tipo B



Tipo C

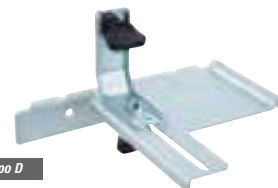

Tipo D

Modelo	Tipo	Un.	Código	EAN	P.V.P. (€)
1100	A	1	161046-2	0088381122962	25,00
1806B	B	1	123053-3	008838115384	12,90
1902 1923B 1923H	C	1	165581-2	0088381361415	5,85
KP0800 DKP180	C	1	195055-9	0088381367110	9,95
KP0810 / C	D	1	122785-9	0088381346023	7,40
DKP181	D	1	191C23-8	0088381557429	29,00



Guia de profundidade



Modelos	Un.	Código	EAN	P.V.P. (€)
KP0810 KP0810C KP0800 1923B 1923H	1	342390-8	0088381346412	2,05

Extensão para guias

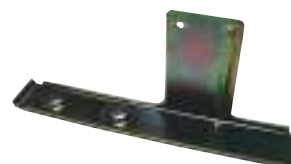

Modelos	Un.	Código	EAN	P.V.P. (€)
1923B 1923H KP0800 DKP180	1	191725-8	0088381126946	13,40

Guia de chanfrar



Podem colocar-se duas guias de chanfrar.

Modelos	Un.	Código	EAN	P.V.P. (€)
KP0810 KP0810C	1	122791-4	0088381343190	27,00
DKP181	2	191C22-0	0088381557405	81,00

Mesa



Modelos	Un.	Código	EAN	P.V.P. (€)
2012NB	1	193902-8	0088381186421	59,00

Suporte para plainas



Modelos	Un.	Código	EAN	P.V.P. (€)
1923H	1	STEX122338	0088381142618	80,00

Adaptador de aspiração

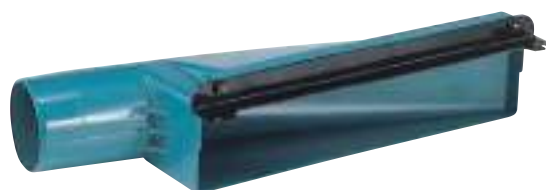

Modelo	Diâmetro de saída	Un.	Código	EAN	P.V.P. (€)
2012NB	76 mm	1	193036-7	0088381154390	27,00

Calibrador de lâminas



Modelos	Un.	Código	EAN	P.V.P. (€)
1100 1923B KP0800 KP0810/C DKP180 DKP181	1	123062-2	0088381111270	2,85

Pedra de afiar



Comprimento total (mm)	Un.	Código	EAN	P.V.P. (€)
150	1	794061-7	0088381110174	10,80
180	1	794060-9	0088381103176	12,90

Chave hexagonal



Forma	mm	Un.	Código	EAN	P.V.P. (€)
L	4,0	1	783202-0	0088381102667	1,05
T	4,0	1	783219-3	0088381369985	2,60
L	2,5	1	783208-8	0088381152624	1,05

Chave de tubo 9



Modelos	Un.	Código	EAN	P.V.P. (€)
1100 KP0800 1923B KP312S KP0810/C	1	782209-3	0088381102568	2,10
2012NB	1	782203-5	0088381161367	2,90

Chave fixa de 8 mm



Modelo	Un.	Código	EAN	P.V.P. (€)
KP301	1	781213-9	0088381102520	2,05

Suporte de afiação



Modelos	Un.	Código	EAN	P.V.P. (€)
1100 1923B KP0800 KP0810/C DKP180 DKP181	1	123004-6	0088381115391	3,10
1806B	1	123006-2	0088381115407	5,55

Saco de pó



Modelos	Un.	Código	EAN	P.V.P. (€)
1806B 1923B	1	122230-4	0088381114981	42,00
2012NB	1	STEX122312	0088381114974	64,00
KP0800 KP0810/C	1	122793-0	0088381346030	17,00
DKP181	1	191C21-2	0088381557450	29,00

Defletor de aparas



Modelos	Un.	Código	EAN	P.V.P. (€)
1923H	1	122354-6	0088381114936	14,40
1100	1	415452-6	0088381142717	3,45
KP301	1	H311225	3240890101976	65,00
KP0800 KP0810/C	1	416368-8	0088381141703	2,05

Esquadro



Modelos	Un.	Código	EAN	P.V.P. (€)
1806B 1923H KP312S	1	762001-3	0088381156912	0,80

Diamante

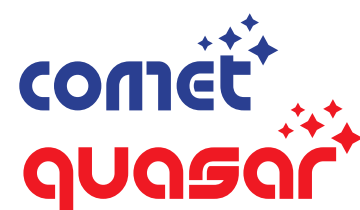

Protetores de disco para rebarbadoras.
Trabalha *sem pó*. Cuida da sua *saúde*.



Discos de diamante



Discos de alta qualidade para todas as aplicações profissionais com tecnologia de posicionamento de diamantes 3DDG.

Tecnologia STEALTH que utiliza 2 discos que fazem de molde sobre um núcleo de aço temperado para reduzir tanto a vibração como o ruído. Cortes mais limpos e mais rápidos.



30 % MAIS DURAÇÃO

50 % MAIS RÁPIDO



A altura dos segmentos é aumentada até 12 mm.



Os dentes em forma de M permitem um bom início do corte.

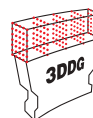

A tecnologia 3D DiamondGrid é um método avançado de fabrico do segmento que ordena os grãos de diamante de forma paralela e uniforme em todo o segmento.

Soldadura a laser que resiste a altas temperaturas.



Discos de diamante Quasar

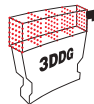

Betão



Mármore Terrazzo



Tijolo médio/duro



Telha cerâmica



Ardozia macia

- Quasar com corpo compacto, mais silencioso, soldado a laser, banda segmentada, baixa vibração, longa duração e tecnologia STEALTH.

D (mm)	B (mm)	Redução (mm)	S (mm)	Especificações	Un.	Código	EAN	P.V.P. (€)
230	22,23	-	12	3DDG Stealth.	1	B-12712	0088381355452	138,00
300	20	-	12		1	B-13459	0088381359160	200,00
350	25,4	20	12		1	B-13465	0088381359177	258,00
400	25,4	20	12		1	B-13471	0088381359184	308,00

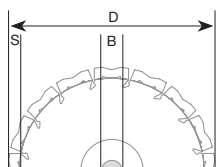

Discos de diamante



30 % MAIS DURAÇÃO

50 % MAIS RÁPIDO

Aberturas de refrigeração para manter a lâmina bem refrigerado durante o corte.

A altura dos segmentos é aumentada até 10 mm.

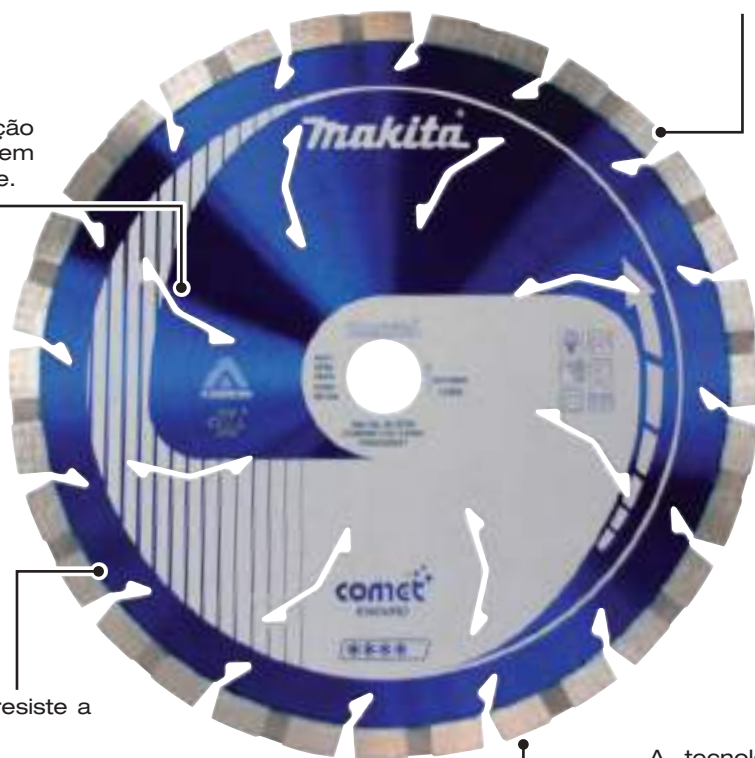

Dentes com um recesso no centro para facilitar a refrigeração

Soldadura a laser que resiste a altas temperaturas.

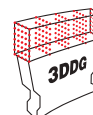

A tecnologia 3D DiamondGrid é um método avançado de fabrico do segmento que ordena os grãos de diamante de forma paralela e uniforme em todo o segmento.



Discos de diamante COMET



- Corpo compacto, mais silencioso.
- Soldado a laser.
- Baixa vibração.

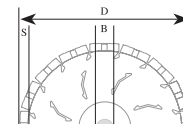
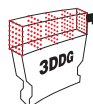

D (mm)	B (mm)	Redução (mm)	S (mm)	Especificações	Un.	Código	EAN	P.V.P. (€)
115	22,23	-	10	Aberturas de refrigeração	1	B-12762	0088381355506	45,00
125	22,23	20	10		1	B-12778	0088381355513	46,00
230	22,23	-	10	3DDG Aberturas de refrigeração Centro reforçado	1	B-12784	0088381355520	104,00
300	20	-	10		1	B-13546	0088381359252	155,00
350	25,4	20	10		1	B-13552	0088381359269	184,00
400	25,4	20	10		1	B-13568	0088381359276	222,00

Discos de diamante COMET banda turbo



- Disco com banda turbo para obter um bom acabamento da peça de trabalho.
- Aberturas de refrigeração que evitam dilatações no disco.
- Soldado a laser para resistir a altas temperaturas.



Mármore
Terrazzo



Tijolo
duro



Granito



Tijolo
macio



Ardósia
macia

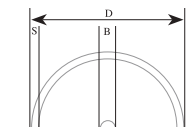

D (mm)	B (mm)	Redução (mm)	S (mm)	Especificações	Un.	Código	EAN	P.V.P. (€)
115	22,23	-	7	Banda turbo Núcleo padrão	1	B-12980	0088381358170	41,00
125	22,23	20	7		1	B-12996	0088381358187	46,00
150	22,23	20	7		1	B-13007	0088381358194	56,00
230	22,23	-	8		1	B-13035	0088381358224	91,00
300	25,4	-	8,5		1	B-13041	0088381358231	168,00
350	25,4	-	8,5		1	B-13057	0088381358248	220,00

Discos de diamante COMET banda contínua



- Acabamento perfeito nos materiais mais duros.
- É recomendado trabalhar com água para uma boa refrigeração.
- Soldado a laser para resistir a altas temperaturas.



Azulejo cerâmico
porcelânico

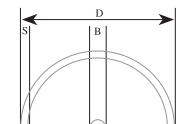

D (mm)	B (mm)	Redução (mm)	S (mm)	Especificações	Un.	Código	EAN	P.V.P. (€)
80	15	-	5	Banda contínua Núcleo padrão	1	B-13063	0088381358255	71,00
115	22,23	-	5		1	B-13085	0088381358279	27,00
125	22,23	-	5		1	B-13091	0088381358286	29,00

Discos de diamante COMET banda contínua eletrodepositada



- Disco de banda contínua com diamante eletrodepositado especial para materiais muito compactos e que requerem um corte muito limpo para evitar ruturas.



GRP



Mármore
Terrazzo



Painel
de fibras



Fibra
de vidro

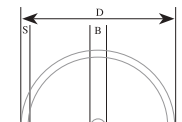

D (mm)	B (mm)	Redução (mm)	S (mm)	Especificações	Un.	Código	EAN	P.V.P. (€)
115	22,23	-	-	Eletrodepositado Núcleo padrão	1	B-13172	0088381358378	54,00
125	22,23	20	-		1	B-13188	0088381358385	55,00
150	22,23	20	-		1	B-13194	0088381358392	74,00
230	22,23	-	-		1	B-13219	0088381358415	144,00
250	22,23	-	-		1	B-13225	0088381358422	263,00

Discos de diamante COMET especial juntas



- Design perfeito para uso em argamassa, bem como em materiais muito abrasivos.
- Para uso em argamassa e tijolo macio.
- Aberturas de refrigeração grandes.

• **Espessura de 6,5 mm**

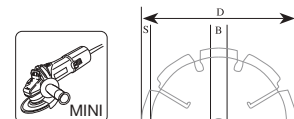

D (mm)	B (mm)	Redução (mm)	S (mm)	Especificações	Un.	Código	EAN	P.V.P. (€)
125	22,23	-	6,5	-	1	B-13253	0088381358453	96,00

Discos de diamante COMET especial asfalto



- Disco especial para trabalhar em asfalto.
- Disco com pastilha de diamante de grande dureza, pois o asfalto é muito abrasivo.
- Banda segmentada para a sua refrigeração, mas é recomendado usar com cortadores de gasolina com refrigeração a água para uma boa duração do disco.

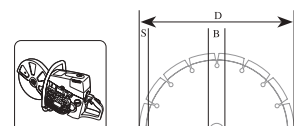

D (mm)	B (mm)	Redução (mm)	S (mm)	Especificações	Un.	Código	EAN	P.V.P. (€)
300	20	-	10	Asfalto Núcleo padrão	1	B-13269	0088381358460	173,00
350	25,4	20	10		1	B-13275	0088381358477	202,00

Discos de diamante NEBULA



- Discos de diamante de qualidade padrão.
- Pro Segment/Laser Welding: reduz o sobreaquecimento e oferece uma vida útil mais longa.
- Para cortar betão, betão armado, tijolo, pedra calcária e arenito.

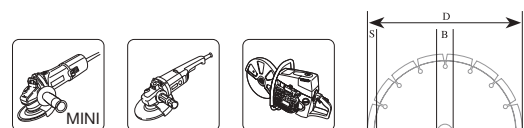

D (mm)	B (mm)	Redução (mm)	S (mm)	Especificações	Un.	Código	EAN	P.V.P. (€)
115	22,23	-	10	Soldadura a laser	1	B-53986	0088381476485	23,00
125	22,23	-	10		1	B-53992	0088381476492	25,00
230	22,23	-	10		1	B-54025	0088381476522	33,00
300	20	-	10		1	B-54031	0088381476539	58,00
350	25,4	20	10		1	B-54053	0088381476553	74,00
400	25,4	20	10		1	B-54069	0088381476560	95,00



- Discos de uso geral para o corte de todos os tipos de material de construção.
- Adequado para materiais de alvenaria.

Discos de diamante DIAMAK banda segmentada



- Gama económica de discos para trabalhos gerais de obra. Pode ser utilizado tanto em cortes secos como molhados. Disponíveis com banda segmentada, turbo e banda contínua.
- Todos os tipos de alvenaria, bloco, tijolo, ardósia e pedra calcária.

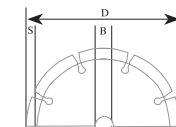

D (mm)	B (mm)	Redução (mm)	S (mm)	Especificações	Un.	Código	EAN	P.V.P. (€)
115	22,23	-	7	Banda segmentada Núcleo padrão	1	D-61123	0088381475778	8,15
125	22,23	-	7		1	D-52766	0088381445177	8,15
150	22,23	-	7		1	B-06432	0088381276122	21,00
230	22,23	-	7		1	D-61145	0088381475792	17,50
300	25,40	-	7,5		1	D-56982	0088381458085	63,00
350	25,40	-	7,5		1	D-56998	0088381458092	78,00
400	25,40	-	7,5		1	D-57009	0088381458108	91,00

Discos de diamante DIAMAK banda turbo



- Para materiais duros, granito, materiais argilosos, ardósia, pedra calcária e betão duro.
- Banda segmentada.
- Núcleo padrão.

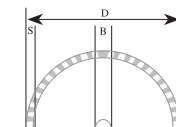

D (mm)	B (mm)	Redução (mm)	S (mm)	Especificações	Un.	Código	EAN	P.V.P. (€)
115	22,23	-	7	Banda segmentada Núcleo padrão	1	D-61151	0088381475808	8,15
125	22,23	20	7		1	D-61167	0088381475815	9,35
230	22,23	-	7		1	D-61173	0088381475822	20,95

Discos de diamante DIAMAK banda contínua



- Para materiais duros, granito, materiais argilosos, ardósia, pedra calcária e betão duro.

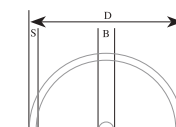

D (mm)	B (mm)	Redução (mm)	S (mm)	Especificações	Un.	Código	EAN	P.V.P. (€)
110	22,23	-	7	Banda contínua Núcleo padrão	1	D-61189	0088381475839	7,00

Disco de diamante especial para ferramentas a bateria



- Novo disco de diamante de 230 mm ideal para cortadores a bateria.
- Com este disco aumentamos a velocidade de corte e a vida útil do mesmo.
- Para conseguir ranhuras mais estreitas, desenhamos o segmento em forma de leque, obtendo um melhor desempenho de trabalho. Os diamantes são distribuídos uniformemente na estrutura do segmento, alcançando assim um desempenho de trabalho estável e reduzindo o consumo de bateria.

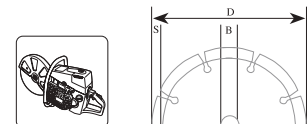

D (mm)	B (mm)	Redução (mm)	S (mm)	Especificações	Un.	Código	EAN	P.V.P. (€)
230	22,23	-	7	especial para DCE090	1	E-02967	0088381475792	139,00



Discos de diamante X-LOCK



- Disco de diamante segmentado X-LOCK 115 x 22,23 mm.
- Os discos de diamante compatíveis com as rebarbadoras X-LOCK permitem uma instalação fácil e segura do disco.

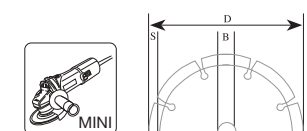

D (mm)	B (mm)	Redução (mm)	S (mm)	Especificações	Un.	Código	EAN	P.V.P. (€)
115	22,23	-	7	Compatível com rebarbadoras X-LOCK	1	E-02060	0088381556217	37,00
125	22,23	-	7		1	E-02076	0088381556224	40,00

Discos de diamante especial vidro e porcelana



- Segmentos contínuos para um corte limpo sem quebrar as arestas de corte de azulejos, cerâmica, mármore, vidro, etc.



D (mm)	B (mm)	Modelo	Un.	Código	EAN	P.V.P. (€)
85	15	CC301D	1	B-21098	0088381399777	35,00



- Segmento contínuo e inclinado com uma largura extrafina de 1,2 mm para o corte rápido e limpo de azulejos, mármore e vidro.



D (mm)	B (mm)	Modelo	Un.	Código	EAN	P.V.P. (€)
110	20	4101RH	1	B-22028	0088381401760	94,00



- Acabamento perfeito nos materiais mais duros. É recomendado trabalhar com água para uma boa refrigeração. Soldado a laser para resistir a altas temperaturas. Indicado para betão e porcelana (não para vidro).



D (mm)	B (mm)	Modelo	Un.	Código	EAN	P.V.P. (€)
125	20	4101RH	1	B-21951	0088381401692	37,00



- Especial para porcelana.
- Disco extrafino, ideal para máquinas a bateria.
- 1,4 mm.



D (mm)	B (mm)	Modelo	Un.	Código	EAN	P.V.P. (€)
115	22,23	Rebarbadoras 115 mm	1	B-46327	0088381452403	36,00



- Especial para porcelana.
- Disco extrafino, ideal para máquinas a bateria.
- 1,4 mm.



D (mm)	B (mm)	Modelo	Un.	Código	EAN	P.V.P. (€)
125	22,23	Rebarbadoras 125 mm	1	B-46333	0088381452410	39,00

Discos de diamante especial resgate



B-55326

- Corta todos os tipos de material.
- Perfeito para operações de resgate.
- Amplamente usado nos quartéis de bombeiros.

D (mm)	B (mm)	Modelo	Un.	Código	EAN	P.V.P. (€)
125	22,23	Rebarbadoras 125 mm	1	B-55310	0088381482035	52,00
230	22,23	Rebarbadoras 230 mm	1	B-55326	0088381482042	97,00
305	22,23	Rebarbadoras 305 mm	1	B-55332	0088381482059	175,00



Discos de diamante para polir betão



B-12289

- Disco para limpar e polir superfícies de betão e pedra natural com um acabamento fino.



B-12295

- Disco para limpar rapidamente camadas grossas de betão.



D-41464

- Gama económica.
- Disco para limpar e polir superfícies de betão e pedra natural com um acabamento fino.



D-41458

- Gama económica.
- Disco para limpar rapidamente camadas grossas de betão.

D (mm)	B (mm)	Modelo	Un.	Código	EAN	P.V.P. (€)
125	22,23	PC5010C	1	B-12289	0088381354042	210,00
125	22,23	PC5010C	1	B-12295	0088381354059	103,00
125	22,23	PC5010C	1	D-41464	0088381404280	62,00
125	22,23	PC5010C	1	D-41458	0088381404273	54,00

Brocas de diamante



Corte a seco - DBM130

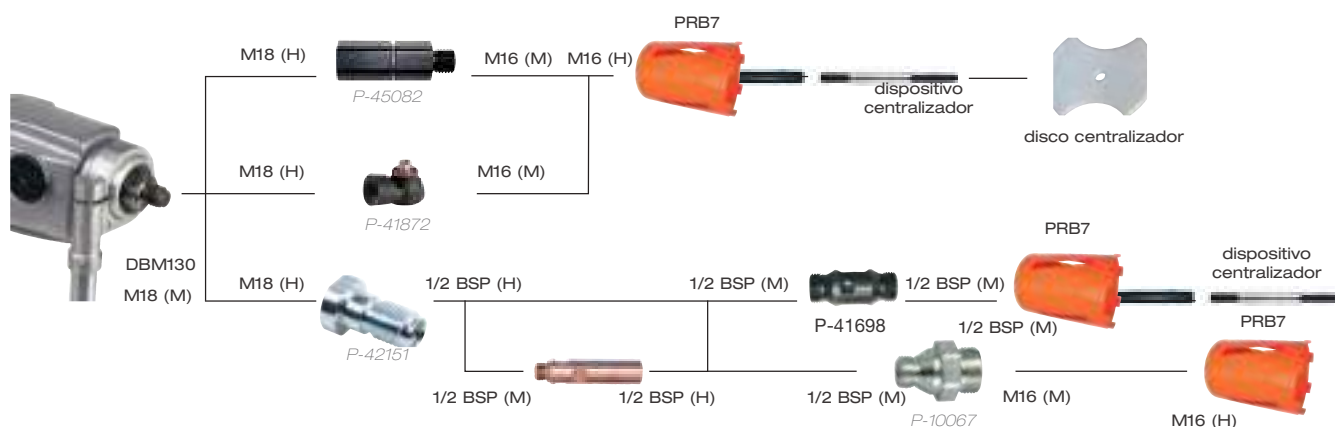

Brocas de coroa de diamante para seco PRB7

- Brocas de diamante para todo o tipo de alvenaria.

Brocas de coroa de diamante para seco DB4

- Brocas de diamante para granito, mármore, tijolo duro e outros materiais abrasivos.

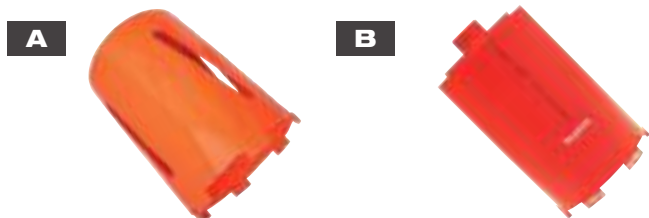

Tipo	Ø (mm)	Comprimento (mm)	Inserção	Un.	Código	EAN	P.V.P. (€)
A	22	300	1/2BSP (H)	1	P-57102	0088381987622	67,00
	28	300		1	P-57118	0088381987639	69,00
	32	150		1	P-57124	0088381987646	69,00
	38	150		1	P-57146	0088381987660	69,00
	48	150		1	P-57152	0088381987677	70,00
	65	150		1	P-57174	0088381987691	72,00
B	68	150	M16 (H)	1	P-63806	0088381994323	97,00
	76	150		1	P-63828	0088381994347	124,00
	132	150		1	P-63921	0088381994446	165,00



Ø (mm)	Comprimento (mm)	Inserção	Un.	Código	EAN	P.V.P. (€)
22	300	1/2BSP (H)	1	P-64060	0088381994583	39,00
28	300		1	P-64076	0088381994590	41,00
32	150		1	P-64082	0088381994606	43,00
38	150		1	P-64098	0088381994613	43,00
48	150		1	P-64107	0088381994620	47,00
52	150		1	P-64113	0088381994637	48,00
65	150		1	P-64129	0088381994644	49,00

Prolongadores para brocas de coroa



Comprimento (mm)	Inserção	Un.	Código	EAN	P.V.P. (€)
100	5/4 UNC	1	P-41604	0088381968614	34,00
200		1	P-41610	0088381968621	39,00
300		1	P-41626	0088381968638	49,00
400		1	P-41632	0088381968645	63,00
500		1	P-41648	0088381968652	79,00
100	1/2 BSP	1	P-41551	0088381968560	24,00
300		1	P-34718	0088381963879	24,00



Dispositivos centradoras



Tipo	Medida	Un.	Código	EAN	P.V.P. (€)
A	60 (ponta)	1	P-41888	0088381968294	25,00
B	340 (para ponta)	1	P-41903	0088381968317	74,00
C	170	1	P-34724	0088381963886	17,50

Adaptadores para berbequins de diamante



Máquina	Broca	Un.	Código	EAN	P.V.P. (€)
5/4 UNC (F)	1/2 BSP (F)	1	P-41676	0088381968683	49,00
1/2 BSP (M)	5/4 UNC (M)	1	P-41682	0088381968690	48,00
1/2 BSP (M)	1/2 BSP (M)	1	P-41698	0088381968706	39,00
1/2 BSP (M)	M16 (M)	1	P-10067	0088381931083	15,70
1/2 BSP (M)	M30 (M)	1	P-10073	0088381931090	16,50
HI	1/2 BSP (F)	1	P-41707	0088381968713	45,00
M18 (F) - 5/4 UNC (M)	1/2 BSP (F)	1	P-42151	0088381970020	33,00
M18 (F)	M30 (M)	1	P-41866	0088381968270	18,45
M18 (F)	M16 (M)	1	P-45082	0088381975193	35,00
SDS-PLUS	1/2 BSP (M)	1	P-30031	0088381958196	20,10
SDS-PLUS	M16 (M)	1	P-67745	0088381998277	21,00

Disco centralizador (para uso com dispositivo centralizador)



Medida	Un.	Código	EAN	P.V.P. (€)
68	1	P-41919	0088381968324	3,35
82	1	P-41931	0088381968348	4,90
132	1	P-41981	0088381968393	10,80

Adaptador de aspiração



* Para funcionamento a seco com o DBM130 ou DBM131.

Rosca (máquina)	Rosca (broca)	Un.	Código	EAN	P.V.P. (€)
De M18 x 2,5	M16 x 2,0	1	P-41872	0088381968287	134,00

Brocas de coroa para rebarbadora (especial mármore)



- Perfuração mais rápida.
- Obtenção fácil do ponto de perfuração através da inclinação da máquina.
- Indicadas para trabalhar em mármore e granito.
- Utilizar apenas a seco.

Ø (mm)	Medida	Un.	Código	EAN	P.V.P. (€)
25	M14	1	D-35025	-	21,25
30	M14	1	D-35019	-	25,00
35	M14	1	D-35003	0088381360272	26,00

Brocas especiais para rebarbadora (especial porcelana)



D-44507



D-61070

Ø (mm)	Medida	Un.	Código	EAN	P.V.P. (€)
6	M14	1	D-61070	0088381475532	17,40
8	M14	1	D-61086	0088381475549	17,95
10	M14	1	D-61092	0088381475556	18,50
12	M14	1	D-61101	0088381475563	26,00
14	M14	1	D-44432	0088381406758	36,00
20	M14	1	D-44454	0088381406772	28,00
25	M14	1	D-44476	0088381406796	35,00
32	M14	1	D-44507	0088381406826	44,00
38	M14	1	D-44529	0088381406840	55,00

Kit de recuperação de água e de vácuo



P-54178

P-54221

Descrição	Un.	Código	EAN	P.V.P. (€)
[1] Membrana	1	P-54184	0088381984690	28,00
Kit de recuperação de água	1	P-54178	0088381984683	196,00
Kit de fixação de vácuo	1	P-54221	0088381984737	97,00

Suporte para DBM131 e DBM130



Descrição	Un.	Código	EAN	P.V.P. (€)
Suporte	1	P-40082	0088381967952	721,00

Suporte para DBM230



*O mesmo kit de ancoragem do que o DBM131.

Descrição	Un.	Código	EAN	P.V.P. (€)
Suporte	1	P-54190	0088381984706	1324,00

Kit de ancoragem para DBM131, DBM130 e DBM230

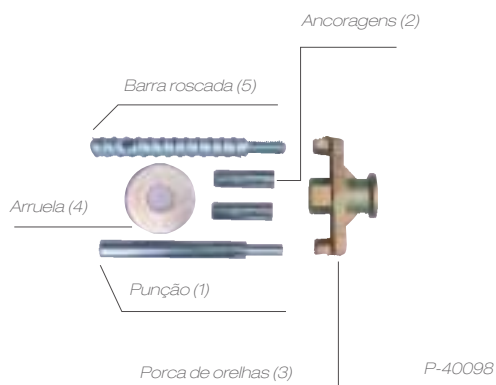

Descrição	Un.	Código	EAN	P.V.P. (€)
Kit de fixação	1	P-40098	0088381967969	35,00
Punção (1)	1	P-40288	0088381968157	12,35
Ancoragens (2)	1	P-40107	0088381967976	1,80
Porca de orelhas (3)	1	P-40113	0088381967983	9,55
Arruela (4)	1	P-40129	0088381967990	4,40
Barra roscada (5)	1	P-41735	0088381968744	12,35

Acessórios para PW5000CH



Discos de polir de diamante



- Discos de polimento de 100 mm para um polimento perfeito da pedra.
- Fixação à base através de velcro.

Grão	Ø (mm)	Tipo	Cor	Un.	Código	EAN	P.V.P. (€)
50	100	Velcro	Azul	1	D-15584	0088381186759	14,85
200			Laranja	1	D-15609	0088381186773	14,85
800			Verde-escuro	1	D-15621	0088381186797	14,85
3000			Castanho	1	D-15643	0088381186810	14,85
CASCA			Verde	1	D-15659	0088381186827	24,00

Prato de velcro



Ø (mm)	Tipo	Un.	Código	EAN	P.V.P. (€)
100	Velcro	1	743080-0	0088381201223	25,00

Abrasivos rebarbadora



Alto Rendimento Comparável a um modelo elétrico



Equipadas com controlo automático de velocidade.

ADT

Altera automaticamente a velocidade de corte para corresponder à carga de trabalho para um funcionamento ótimo.

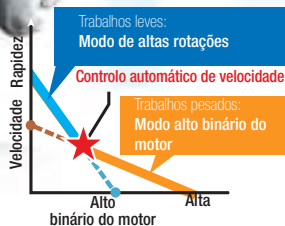

Função inteligente para minimizar o recuo.

AFT

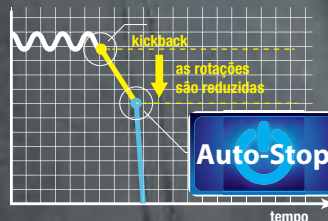

Desliga a ferramenta para proteger o utilizador se a velocidade de rotação descer repentinamente (por exemplo, kick-back).

XLOCK

Novos discos para mini rebarbadoras 18V 115/125 mm com sistema XLOCK. Permite trocar o disco rapidamente, sem ferramentas e sem esforço.

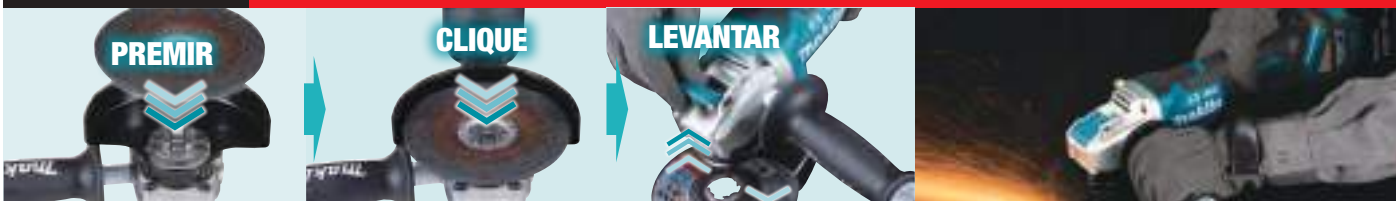

115 mm	125 mm	Bateria	Velocidade (rpm)	Interruptor deslizante	Interruptor alavanca	SAR Sistema Anti-Recuo	Travão (BRAKE)	ADT	AFT
-	GA005G	XGT 40V Li-Ion max	8500	✓	-	✓	✓	-	✓
-	GA013G		8500	-	✓	✓	✓	-	✓
GA022G	-		3000 - 8500	✓	-	✓	✓	-	✓
-	GA023G		3000 - 8500	✓	-	✓	✓	-	✓
GA028G	-		3000 - 8500	-	✓	✓	✓	-	✓
-	GA029G		3000 - 8500	-	✓	✓	✓	-	✓
DGA452	-	18V LITH-ION	8500	✓	-	✓	-	-	-
DGA454	DGA504		8500	✓	-	✓	-	✓	-
DGA458	DGA508		8500	-	✓	✓	✓	✓	✓
DGA461	DGA511		8500	✓	-	✓	-	✓	✓
DGA463	DGA513		3000 - 8500	✓	-	✓	✓	✓	✓
DGA467	DGA517		3000 - 8500	-	✓	✓	✓	✓	✓
-	DGA518		8500	-	✓	✓	✓	✓	✓
DGA469	DGA519		3000 - 8500	-	✓	✓	✓	✓	✓
150 mm	GA035G		XGT 40V Li-Ion max	8500	✓	-	✓	✓	-
230 mm	DGA900 DGA901	20V + 20V 36V	3000 - 8500	-	✓	✓	-	✓	✓
	GA036G	XGT 40V Li-Ion max	8500	-	✓	✓	✓	-	✓
	GA038G	XGT 40V Li-Ion max	6600	-	✓	✓	✓	-	✓

Discos abrasivos de rebarbar



Material	Ø ext. (mm)	Ø int. (mm)	Espessura (mm)	Un.	Código	EAN	P.V.P. (€)
Metal	115	22,23	6,4	1	P-52978	0088381983488	1,55
Metal	125	22,23	6,4	1	P-52984	0088381983495	1,80
Metal	150	22,23	6,4	1	P-52990	0088381983501	2,60
Metal	180	22,23	7	1	P-52227	0088381982733	3,10
Metal	230	22,23	7	1	P-52819	0088381983327	4,40

Discos abrasivos de rebarbar para metal especial da indústria pesada



Material	Ø ext. (mm)	Ø int. (mm)	Espessura (mm)	Un.	Código	EAN	P.V.P. (€)
Inox	115	22,23	7,2	1	B-56378	0088381490061	3,60
Inox	125	22,23	7,2	1	B-56390	0088381490085	4,10

Discos abrasivos de corte



Material	Ø ext. (mm)	Ø int. (mm)	Espessura (mm)	Un.	Código	EAN	P.V.P. (€)
Metal A	115	22,23	3,2	1	P-52174	0088381982689	1,10
	125	22,23	3,2	1	P-52180	0088381982696	1,30
	150	22,23	3,2	1	P-52928	0088381983433	1,80
	180	22,23	3,2	1	P-52934	0088381983440	1,80
	230	22,23	3,2	1	P-52196	0088381982702	2,40
Pedra B	115	22,23	3,2	1	P-52205	0088381982719	1,30
	125	22,23	3,2	1	P-52940	0088381983457	1,55
	180	22,23	3,2	1	P-52962	0088381983471	2,05
	230	22,23	3,2	1	P-52211	0088381982726	2,85
Metal C	300	25,4	3	1	P-53148	0088381983655	3,85
	350	25,4	3	1	P-53154	0088381983662	5,15
Pedra D	300	20	3,2	1	721710-3	-	15,45
	350	25,4	4	1	721715A3	-	23,00
	400	20	4,7	1	724406-5	-	43,00

Discos abrasivos de rebarbar



Material	Ø ext. (mm)	Ø int. (mm)	Espessura (mm)	Un.	Código	EAN	P.V.P. (€)
Metal	115	22,23	6	1	E-00365	0088381555395	1,75
Metal	125	22,23	6	1	E-00393	0088381555425	2,05
Inox	115	22,23	6	1	E-00371	0088381555401	2,25
Inox	125	22,23	6	1	E-00402	0088381555432	2,80

Discos abrasivos de corte extrafinos



Material	Ø ext. (mm)	Ø int. (mm)	Espessura (mm)	Un.	Código	EAN	P.V.P. (€)
Metal	115	22,23	1,2	1	E-00387	0088381555418	1,85
Metal	125	22,23	1,2	1	E-00418	0088381555449	2,05

Discos abrasivos de corte extrafinos

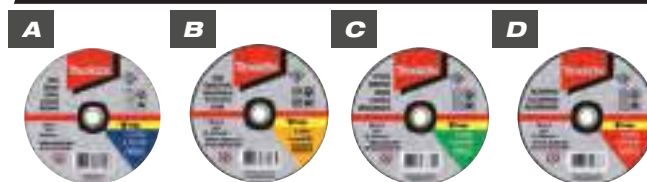

Material	Ø ext. (mm)	Ø int. (mm)	Espessura (mm)	Un.	Código	EAN	P.V.P. (€)
Metal A	115	22,23	1	1	P-53001	0088381983518	1,30
	115	22,23	1,6	1	P-53017	0088381983525	1,30
	125	22,23	1	1	P-53023	0088381983532	1,35
	125	22,23	1,6	1	P-53039	0088381983549	1,35
	230	22,23	2	1	P-52233	0088381982740	3,10
	Inox B	115	22,23	1	1	P-52249	0088381982757
115		22,23	1,6	1	P-52255	0088381982764	1,30
125		22,23	1	1	P-53045	0088381983556	1,30
125		22,23	1,6	1	P-53051	0088381983563	1,35
230		22,23	2	1	P-53067	0088381983570	3,10
Pedra C	115	22,23	1	1	P-53073	0088381983587	1,30
	115	22,23	1,6	1	P-53089	0088381983594	1,80
	125	22,23	1	1	P-53095	0088381983600	1,35
Alumínio D	115	22,23	1,6	1	P-53126	0088381983631	1,30

Pacotes de discos de corte fino



Material	Ø ext. (mm)	Ø int. (mm)	Espessura (mm)	Un.	Código	EAN	P.V.P. (€)
Inox	115	22,23	1	10	D-65953-10	0088381561815	6,90
Inox	125	22,23	1	10	D-65969-10	0088381561822	7,95
Inox	115	22,23	0,8	12	E-10861-12	-	19,55
Inox	125	22,23	0,8	12	E-10877-12	-	22,00

Novos discos abrasivos multimaterial



Disco abrasivo para DCE090

- Para corte rápido.
- Produz menos pó e rebarbas a partir de materiais.



Material	Ø ext. (mm)	Ø int. (mm)	Espessura (mm)	Un.	Código	EAN	P.V.P. (€)
Inox	230	22,23	2	25	E-03006-25	0088381567442	57,00

Discos abrasivos multimaterial

- A roda de corte fino é adequada para uma vasta gama de materiais.
- São adequados para utilização na construção, canalização, etc.

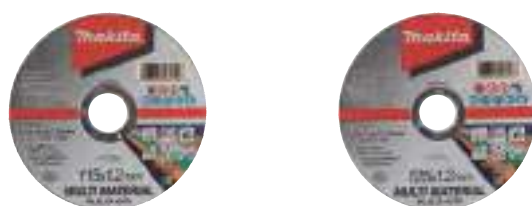

Material	Ø ext. (mm)	Ø int. (mm)	Espessura (mm)	Un.	Código	EAN	P.V.P. (€)
Multi material	115	22,23	1,2	1	E-10718	0088381580526	1,55
Multi material	125	22,23	1,2	1	E-10724	0088381580533	1,80

Discos abrasivos para cortadores



Material	Ø ext. (mm)	Ø int. (mm)	Espessura (mm)	Un.	Código	EAN	P.V.P. (€)
Metal	355	25,4	3	5	B-10665-5	0088381348058	21,00
Alumínio	355	25,4	2,8	5	E-04977-5	-	39,00

Pedras de afiar



Grão	Ø ext. (mm)	Ø int. (mm)	Espessura (mm)	Un.	Código	EAN	P.V.P. (€)
Para GS5000							
24	125	20	20	1	B-28662	0088381414890	57,00
36	125	20	20	1	B-28678	0088381414906	57,00
Para GS6000							
24	150	20	20	1	B-28684	0088381414913	72,00
36	150	20	20	1	B-28690	0088381414920	72,00

Novas							
Para GB801							
120	205	15,88	19	1	B-51976		28,00
60	205	15,88	19	1	B-51960		22,00
Para GB602							
120	150	12,7	16	1	B-51932		15,40
60	150	1,7	16	1	B-51926		13,80

Discos de lâminas

- Para rebarbar, desoxidar, limpar ou rebaixar os cordões de soldadura em metais, alumínio e outras ligas.
- Também podem ser utilizados em trabalhos de carpintaria, decapagem de móveis, lixamento de betumes, trabalhos em vigas velhas, etc.
- Corpo em fibra de vidro: o mais comum no mercado. Mais económico que o de nylon, oferece: Leveza e flexibilidade.
- Corpo de nylon: para os trabalhos de lixamento mais exigentes. São indicados para lixamentos que requerem uma grande pressão sobre o material. Melhor desempenho e maior qualidade.
- Forma de disco curvo: permite trabalhar em superfícies moldadas. Ideal para lixar tubos e cordões de soldadura.
- Forma de disco plano: perfeito para trabalhar em superfícies planas, conseguindo assim um acabamento mais uniforme neste tipo de superfícies.

Tabela de aplicação

Madeira		★★★★★			
Plástico		★★★★★			
Metais		★★★★★	★★★★★	★★★★★	
Metais não ferrosos		★★★★★	★★★★★	★★★★★	
Aço inoxidável			★★★★★	★★★★★	
Tijolo, pedra, betão					★★★★★

Discos de lâminas - Óxido de alumínio



- Discos com abrasivo de óxido de alumínio, adequados para uma ampla gama de materiais: metais ferrosos e não ferrosos, plásticos e madeira.



Tipo curvo



Corpo em fibra de vidro

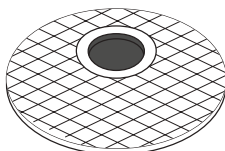

Materiais



Metal



Plástico



Madeira



Metais não ferrosos

Ø ext. (mm)	Ø int. (mm)	Grão	R.p.m	Un.	Código	EAN	P.V.P. (€)
115		40	13290	1	D-27034	0088381343633	3,15
		60	13290		D-27040	0088381343640	3,15
		80	13290		D-27056	0088381343657	3,15
		120	13290		D-27062	0088381343664	3,15
125	22,23	40	13290	1	D-27084	0088381343688	3,60
		60	13290		D-27090	0088381343695	3,60
		80	13290		D-27109	0088381343701	3,60
		120	13290		D-27115	0088381343718	3,60
180		40	8600	1	D-27137	0088381343732	7,20
		60	8600		D-27143	0088381343749	7,20
		80	8600		D-27159	0088381343756	7,20
		120	8600		D-27165	0088381343763	7,20

Discos de lâminas - Óxido de alumínio cerâmico



- Ideal para metais inoxidáveis, titânio, níquel e outros metais de alta densidade.
- A gama alta dos discos de lâminas.



Tipo curvo



Corpo em fibra de vidro

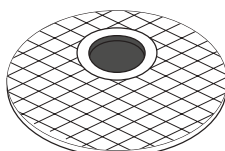

Materiais



Metal



Aço inoxidável



Metais não ferrosos

Ø ext. (mm)	Ø int. (mm)	Grão	R.p.m	Un.	Código	EAN	P.V.P. (€)
115		40	13290	1	D-28298	0088381344890	6,45
		60	13290		D-28307	0088381344906	6,45
		80	13290		D-28313	0088381344913	6,45
		120	13290		D-28329	0088381344920	6,45
125	22,23	40	13290	1	D-28335	0088381344937	7,45
		60	13290		D-28341	0088381344944	7,45
		80	13290		D-28357	0088381344951	7,45
		120	13290		D-28363	0088381344968	7,45
180		40	8600	1	D-28379	0088381344975	13,40
		60	8600		D-28385	0088381344982	13,40
		80	8600		D-28391	0088381344999	13,40
		120	8600		D-28400	0088381345002	13,40

Discos de lâminas - Zircónio



- Discos com abrasivo de Zircónio perfeitos para trabalhos em metal e aço inoxidável.
- "O disco mais popular do mercado".



Tipo curvo



Corpo em fibra de vidro

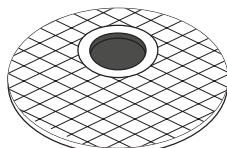

Materiais

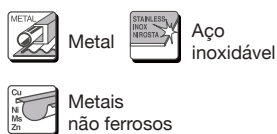

Ø ext. (mm)	Ø int. (mm)	Grão	R.p.m	Un.	Código	EAN	P.V.P. (€)
115		40	13290	1	D-53724	0088381445320	2,90
		60	13290		D-53730	0088381445337	2,90
		80	13290		D-53746	0088381445344	2,90
125	22,23	120	13290		D-53752	0088381445351	2,90
		40	13290		D-53774	0088381445375	3,35
		60	13290		D-53780	0088381445382	3,35
		80	13290		D-53796	0088381445399	3,35
180		120	13290		D-53805	0088381445405	3,35
		40	8600		D-53827	0088381445429	7,45
		60	8600		D-53833	0088381445436	7,45
		80	8600		D-53849	0088381445443	7,45
		120	8600		D-53855	0088381445450	7,45



Ø ext. (mm)	Ø int. (mm)	Grão	R.p.m	Un.	Código	EAN	P.V.P. (€)
115		40	13290	1	D-63747	0088381525350	1,85
		60	13290		D-63753	0088381525367	1,85
		80	13290		D-63769	0088381525374	1,85
		120	13290		D-63775	0088381525381	1,85
125	22,23	40	13290		D-63781	0088381525398	2,15
		60	13290		D-63797	0088381525404	2,15
		80	13290		D-63806	0088381525411	2,10
		120	13290		D-63812	0088381525428	2,10
180		40	8600		D-63828	0088381525435	4,25
		60	8600		D-63834	0088381525442	4,25
		80	8600		D-63840	0088381525459	4,25
		120	8600		D-63856	0088381525466	4,25

- Os discos de nylon são ideais para os trabalhos de lixamento mais exigentes. São indicados para lixamentos que requerem uma grande pressão sobre o material, conseguindo assim um poder de lixamento maior do que com qualquer outro disco.
- Oferecem maior desempenho e maior qualidade. Mantêm as lâminas até ao fim do abrasivo.



Tipo plano



Corpo de nylon

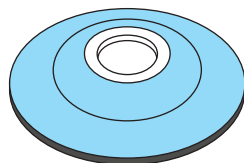

Materiais

Ø ext. (mm)	Ø int. (mm)	Grão	R.p.m	Un.	Código	EAN	P.V.P. (€)
115		40	13290	1	D-27838	0088381344432	5,15
		60	13290		D-27844	0088381344449	5,15
		80	13290		D-27850	0088381344456	5,15
		120	13290		D-27866	0088381344463	5,15
125	22,23	40	13290		D-27888	0088381344487	6,20
		60	13290		D-27894	0088381344494	6,20
		80	13290		D-27903	0088381344500	6,20
		120	13290		D-27919	0088381344517	6,20
180		40	8600		D-27931	0088381344531	10,30
		60	8600		D-27947	0088381344548	10,30
		80	8600		D-27953	0088381344555	10,30
		120	8600		D-27969	0088381344562	10,30

Discos de lâminas - Carboneto de silício



- Discos com abrasivo de carboneto de silício muito eficazes em materiais como tijolo, pedra e betão.
- Não é necessário trabalhá-lo com água.



Tipo plano



Corpo em fibra de vidro

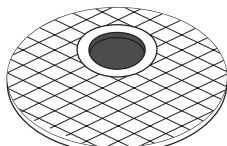

Materiais

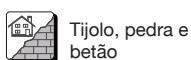

Ø ext. (mm)	Ø int. (mm)	Grão	R.p.m	Un.	Código	EAN	P.V.P. (€)
115	22,23	40	13290	1	D-28036	0088381344630	3,70
		60	13290		D-28042	0088381344647	3,70
		80	13290		D-28058	0088381344654	3,70
		120	13290		D-28064	0088381344661	3,70
125	22,23	40	13290		D-28086	0088381344685	4,20
		60	13290		D-28092	0088381344692	4,20
		80	13290		D-28101	0088381344708	4,20
		120	13290		D-28117	0088381344715	4,20
180	22,23	40	8600		D-28139	0088381344739	7,20
		60	8600		D-28145	0088381344746	7,20
		80	8600		D-28151	0088381344753	7,20
		120	8600		D-28167	0088381344760	7,20

- Discos de nylon para os trabalhos mais exigentes. Indicados para lixamentos que requerem uma grande pressão sobre o material, conseguindo assim um poder de lixamento maior. Melhor desempenho e maior qualidade.



Tipo plano



Corpo de nylon

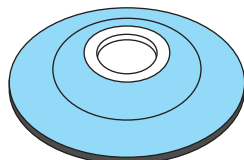

Materiais

Ø ext. (mm)	Ø int. (mm)	Grão	R.p.m	Un.	Código	EAN	P.V.P. (€)
115	22,23	40	13290	1	D-28173	0088381344777	5,15
		60	13290		D-28189	0088381344784	5,15
		80	13290		D-28195	0088381344791	5,15
		120	13290		D-28204	0088381344807	5,15
180	22,23	40	8600		D-28210	0088381344814	10,30
		60	8600		D-28226	0088381344821	10,30
		80	8600		D-28232	0088381344838	10,30
		120	8600		D-28248	0088381344845	10,30

Discos abrasivos - Scotch

- Discos abrasivos de Scotch para a limpeza de superfícies metálicas, de aço inoxidável ou de metais não ferrosos. Também podem ser utilizados em superfícies polidas de pedra.
- O acabamento obtido com estes discos é melhor do que o obtido com discos de lâminas e discos de retificação.
- Com este tipo de discos não é necessário aplicar demasiada pressão, conseguimos um bom lixamento com pouca força, por isso obtemos um acabamento muito bom e uma maior vida útil do disco.
- São ideais para superfícies irregulares, como chapa palito, graças à ligeira flexibilidade dos discos.



Ø ext. (mm)	Ø int. (mm)	Un.	Código	EAN	P.V.P. (€)
115	22,23	1	B-28977	0088381415200	9,55
125	22,23	1	B-28983	0088381415217	10,55

Discos de lâminas - Velo

- Indicado para o polimento de metais. Perfeito para aços fortes e ligas resistentes à corrosão.
- Contém pouco Fe, S e Cl, portanto, é resistente à ferrugem.
- Dependendo da espessura da fibra, podemos remover rebarbas ou polir.
- Revestido com uma resina de alumina que permite uma operação mais rápida e menos potente.
- As fibras de velo impedem a abrasão do material.



As fibras de velo finas e flexíveis proporcionam um bom acabamento superficial. Até o dobro da duração dos outros discos de velo. Ideal para usar depois de um disco abrasivo



Ø ext. (mm)	Ø int. (mm)	Grão	Un.	Código	EAN	P.V.P. (€)
115	22,23	Grosso	1	B-40917	0088381439237	9,55
125		Grosso		B-40951	0088381439275	11,05
115		Médio		B-40923	0088381439244	9,55
125		Médio		B-40967	0088381439282	11,05
115		Fino		B-40939	0088381439251	9,55
125		Fino		B-40973	0088381439299	11,05
115		Superfino		B-40945	0088381439268	9,55
125		Superfino		B-40989	0088381439305	11,05

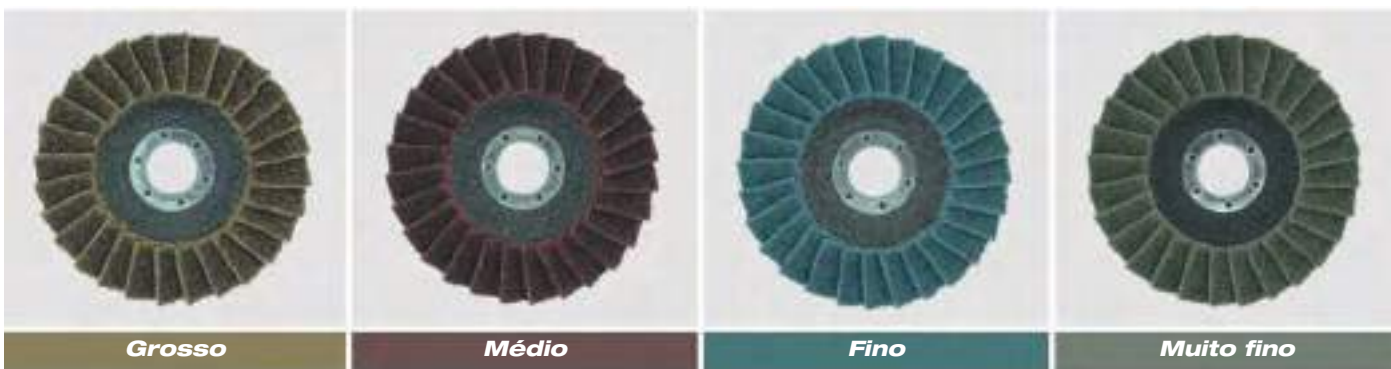

Aplicação



Limpeza em cordões de soldadura

Polimento em óxido

Polimento



Mós



Modelo	Tipo de abrasivo	Inserção	Ø da mó (mm)	Un.	Código	EAN	P.V.P. (€)
GD0600 GD0601 GD0602 GD0603	A para aço médio	3	5	1	794050-2	0088381110211	1,30
GD0800C GD0801C GD0810C GD0811C		3	6	1	794051-0	0088381110228	1,30
		3	10	1	794053-6	0088381110242	1,30
		3	10	1	794059-4	0088381110303	2,85

Punhos

Modelo	Descrição	Un.		Código	EAN	P.V.P. (€)	
Para rebarbadoras de: 115 mm 125 mm 150 mm	Rígido	1		153489-2	0088381193054	1,10	
	Antivibrações	1		162258-0	0088381343381	12,85	
Para rebarbadoras: 9015B 9016B Lixadora 9218SB	Rígido	1		152492-0	0088381131599	2,85	
Para rebarbadoras: 180 mm 230 mm	Rígido	1		151776-3	0088381156073	10,80	
Para rebarbadoras: 180 mm 230 mm	Antivibrações	1		162264-5	0088381345828	15,00	
	De corte	1		194684-5	0088381349895	13,80	

Coletores de pó

O pó pode causar doenças respiratórias graves. Para tentar evitá-lo, a Makita recomenda o uso de um coletor de pó com uma taxa de aspiração de até 90% das partículas. Caixa de alumínio para maior vida útil. Possibilidade de bloquear o disco na profundidade desejada. Visor com protetor transparente.

Coletor de pó rebarbadoras 230 mm

Coletor de pó rebarbadoras 125 mm



Diâmetro (mm)	Descrição	Un.	Código	EAN	P.V.P. (€)
230	Alumínio. Possibilidade de bloquear o disco. Visor transparente.	1	198440-5	0088381487368	136,00



Diâmetro (mm)	Descrição	Un.	Código	EAN	P.V.P. (€)
125	Alumínio. Possibilidade de bloquear o disco. Visor transparente.	1	196845-3	0088381442527	76,00
125	Com engate rápido sem ferramentas*	1	191G06-2	0088381566001	81,00

* Para rebarbadoras com engate rápido do disco.

Coletores de pó adequados para rebarbadoras de 115 mm, 125 mm e 180 mm. Especialmente concebido para usos em lixamentos com discos de diamante em betão. Modelos de rebarbadoras compatíveis: 1100 W de potência ou superior. Alta capacidade de aspiração. Adequado para esquinas graças ao seu sistema de duas peças.

Modelos	Diâmetro (mm)	Descrição	Un.	Código	EAN	P.V.P. (€)
Rebarbadoras de 115/125 mm X-LOCK.	115/125	Especialmente concebido para usos em lixamentos com discos.	1	191F81-2	0088381565479	49,00
Rebarbadoras de 115/125 mm.	115/125		1	195239-9	0088381361804	49,00
Rebarbadoras de 180 mm.	180		1	195385-8	0088381369381	66,00



Protetores de disco

Tipo padrão



Parafuso



Rápido

Modelos	Ø (mm)	Fecho	Un.	Código	EAN	P.V.P. (€)	
9557NBR	115	Parafuso	1	123098-1	0088381451383	7,20	
9557NBRK1			1	123098-1	0088381451383	7,20	
9557NBRX2			1	123098-1	0088381451383	7,20	
9558NBR	125	Parafuso	1	123099-9	0088381451390	7,75	
9558NBRK1			1	123099-9	0088381451390	7,75	
9558PBY			1	123099-9	0088381451390	7,75	
9565CR	125	Rápido	1	123145-8	0088381420181	9,10	
9565CVR			1	123145-8	0088381420181	9,10	
9565PCV			1	123145-8	0088381420181	9,10	
9566PCV01	150		1	123146-6	0088381420198	11,35	
GA4530R	115	Parafuso	1	123098-1	0088381451383	7,20	
GA4534			1	123098-1	0088381451383	7,20	
GA4540C		Rápido	1	123144-0	0088381420167	9,75	
GA4540RZ		Parafuso	1	123098-1	0088381451383	7,20	
GA5021C	125	Rápido	1	123145-8	0088381420181	9,10	
GA5030R		Parafuso	1	123099-9	0088381451390	7,75	
GA5034			1	123099-9	0088381451390	7,75	
GA5040C		Rápido	1	123145-8	0088381420181	9,10	
GA5040C01			Rápido	1	123145-8	0088381420181	9,10
GA5040RZ			Parafuso	1	123099-9	0088381451390	7,75
GA6021C	150	Rápido	1	123146-6	0088381420198	11,35	
GA6040C			1	123146-6	0088381420198	11,35	
GA7012C	180		1	122846-5	3240890337726	13,05	
GA7020R		Parafuso	1	122889-7	0088381364447	8,95	
GA7030R			1	122889-7	0088381364447	8,95	
GA7040R			1	122889-7	0088381364447	8,95	
GA7050			1	122889-7	0088381364447	8,95	
GA7050R			1	122889-7	0088381364447	8,95	
GA7060R			1	122889-7	0088381364447	8,95	
GA7061R		1	122889-7	0088381364447	8,95		
GA9012C		Rápido	1	163411-1	0088381201155	30,00	
GA9020R	230	Parafuso	1	122891-0	3240890337696	10,30	
GA9020RKD			1	122891-0	3240890337696	10,30	
GA9020SFYK			1	122891-0	3240890337696	10,30	
GA9030R			1	122891-0	3240890337696	10,30	
GA9040R			1	122891-0	3240890337696	10,30	
GA9050			1	122891-0	3240890337696	10,30	
GA9050R			1	122891-0	3240890337696	10,30	
GA9060R			1	122891-0	3240890337696	10,30	
GA9061R			1	122891-0	3240890337696	10,30	

Tipo especial para corte com disco abrasivo



122913-6



199709-0



Ø (mm)	Fecho	Un.	Código	EAN	P.V.P. (€)
125 mm	Parafuso	1	122911-0	0088381367134	8,30
230 mm		1	122913-6	0088381367141	16,30
115 mm	Para colocar sobre o protetor	1	199709-0	0088381544665	9,40
125 mm		1	199710-5	0088381544672	9,90

Anilha centradora e porca



224415-9



224543-0

Descrição	Tipo	Modelos	Un.	Código	EAN	P.V.P. (€)
Arruela	M14	"Ø 115, Ø 125, Ø 150, Ø 180, Ø 230 mm."	1	224415-9	0088381348256	1,50
Porca	M14		1	224543-0	0088381116176	1,95

Tipo especial para limpeza com catrabuchas



Ø (mm)	Fecho	Un.	Código	EAN	P.V.P. (€)
60 - 75 mm	Parafuso	1	192454-6	0088381200912	39,00

Protetor para rebarbadoras retas



Modelos	Ø (mm)	Fecho	Un.	Código	EAN	P.V.P. (€)
GS5000	125	Parafuso	1	123199-5	3240890390677	22,00
GS6000	150			123200-6	-	23,00

Porca de fecho rápido Ezy nut



Descrição	Tipo	Modelos	Un.	Código	EAN	P.V.P. (€)
Porca rápida	M14	Rebarbadoras de 180 mm e 230 mm	1	195354-9	0088381367189	41,00

Super - Flange (aperto automático)



Descrição	Tipo	Modelos	Un.	Código	EAN	P.V.P. (€)
Arruela	M14	Todos os modelos	1	192227-7	0088381117371	14,40
Porca	M14		1	125052-1	0088381155960	11,35

Jogo de filtros

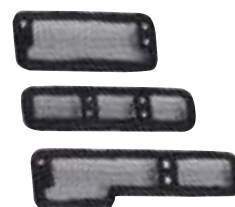
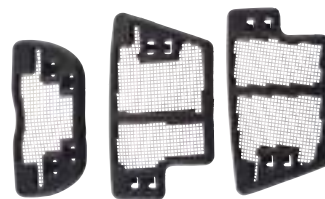

Modelos	Un.	Código	EAN	P.V.P. (€)
GA4550R GA5050R	1	199514-5	0088381586559	26,00
GA4540R GA4540C GA5040R GA5040C GA6040C SA5040C	1	198719-4	0088381534857	16,05
9565CR 9565CVR	1	193903-6	0088381187619	14,95
9565PCV	1	195446-4	0088381486057	11,35
GA7012C GA9012C GA5021C GA6021C	1	193956-5	0088381191982	8,50
GA7020R GA7030R GA7040R GA9020R GA9030R GA9040R	1	194289-1	0088381341950	2,05



Rebarbadoras angulares

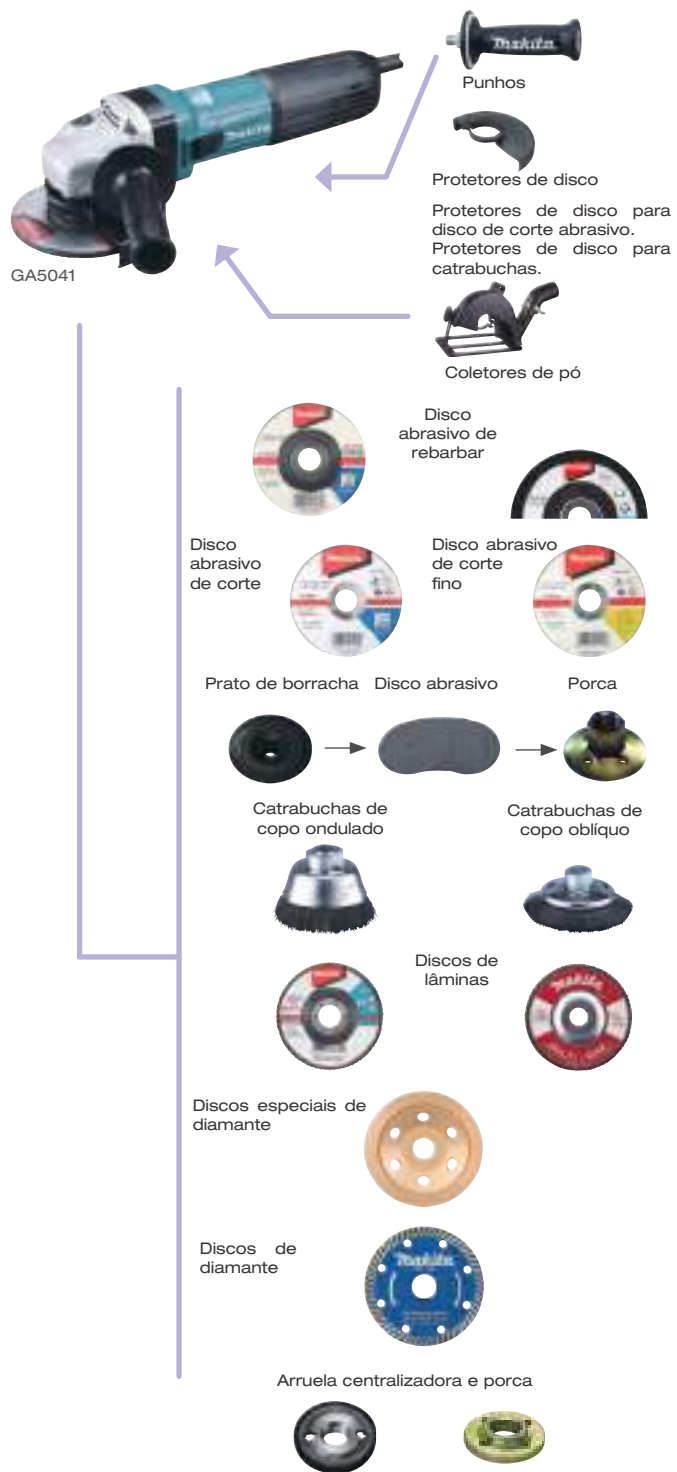

Rebarbadoras retas



Rebarbadoras retas com discos



Casquilhos cónicos para rebarbadoras retas



Porca

Casquilho



Modelo	Ø (mm)	Descrição	Un.	Código	EAN	P.V.P. (€)
GD0600 GD0601	3	Casquilho	1	763627-4	0088381114769	12,35
	6		1	763620-8	0088381114776	10,10
	6,35 (1/4")		1	763625-8	0088381102339	11,85
	-	Porca	1	763664-8	3240890340672	1,30
GD0602 DGD800	3	Casquilho	1	763669-8	0088381435925	17,00
	6		1	763670-3	0088381435932	8,50
	8		1	763671-1	0088381435949	17,00
	-	Porca	1	763668-0	0088381495714	1,55
GD0603	6	Casquilho	1	763620-8	0088381114776	10,10
	-	Porca	1	763236-9	0088381495684	2,95
GD0800C GD0801C GD0810C GD0811C	3	Casquilho + Porca	1	193011-3	0088381156394	23,00
	6		1	193012-1	0088381156400	19,05
	6,35 (1/4")		1	193143-6	0088381156363	23,00
	8		1	192988-9	0088381156387	24,00
	6	Casquilho	1	763646-0	0088381170345	14,40
	-	Porca	1	763645-2	0088381170338	2,45



Suporte



Modelos	Un.	Código	EAN	P.V.P. (€)
GD0800C GD0810C	1	193141-0	0088381156745	64,00

Punho lateral



Modelos	Un.	Código	EAN	P.V.P. (€)
GD0600C GD0601C GD0800C GD0810C	1	192985-5	0088381156417	14,00

Chaves para rebarbadoras retas



Modelo	Medida (mm)	Un.	Código	EAN	P.V.P. (€)
GD0602 GD0601 GD0600	13	1	781039-9	0088381290630	1,15
GD0800C GD0810C	19	1	781206-6	0088381124072	3,85
GD0800C GD0810C	13	1	781203-2	0088381102476	2,60

Chaves de pivôs



Modelos	Un.	Código	EAN	P.V.P. (€)
115, 125 e 150 mm	1	782423-1	0088381572323	1,60
180 - 230 mm	1	197610-3	0088381519007	2,15

Acessórios para cortadores

Válvula completa



Modelos	Un.	Código	EAN	P.V.P. (€)
4101RH	1	153409-6	0088381201148	17,00

Tubo de vinil



Modelos	Un.	Código	EAN	P.V.P. (€)
4100NB 4101RH	1	412088-2	0088381538459	3,30

Guia lateral



Modelos	Un.	Código	EAN	P.V.P. (€)
5604R 5704R 4100KB 4101RH N4105KB 4131	1	164095-8	0088381101080	1,80

Interruptor de segurança



Modelos	Un.	Código	EAN	P.V.P. (€)
4101RH	1	P-21571	3240890106254	52,00

Adaptador de Guia de carril 4100KB



Modelos	Un.	Código	EAN	P.V.P. (€)
4100KB	1	198673-2	0088381497374	25,00

Acessórios para PW5000CH

Transformador de isolamento



Descrição	Un.	Código	EAN	P.V.P. (€)
Transformador que evita derivações para o utilizador	1	P-67016	0088381997546	545,00

Punho



Un.	Código	EAN	P.V.P. (€)
1	153489-2	0088381193054	1,10

Protetor de cabeça



Un.	Código	EAN	P.V.P. (€)
1	417322-5	0088381156981	7,60



Acessórios para PC5001C

Saco de pó



Un.	Código	EAN	P.V.P. (€)
1	122853-8	0088381358637	4,90

Conjunto de escovas



Un.	Código	EAN	P.V.P. (€)
1	194921-7	0088381358675	7,70

Chave 5,6



Un.	Código	EAN	P.V.P. (€)
1	410047-0	0088381123686	0,75



Casquilho redutor



Ø exterior (mm)	Ø interior (mm)	Un.	Código	EAN	P.V.P. (€)
22,23	20	10	A-85248	0088381538596	8,75
25,4	20	1	197318-9	0088381234733	10,50



Jogo de filtros de ar

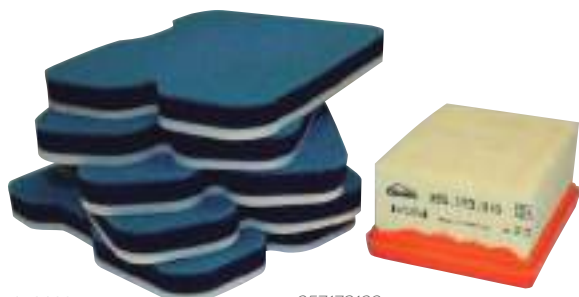

957173190

957173190

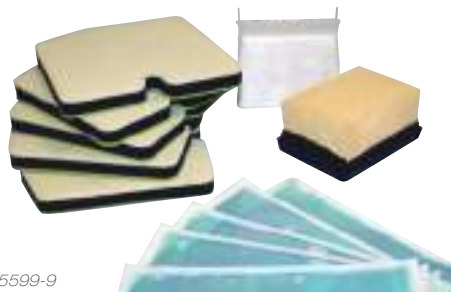

195599-9

Descrição	Modelo	Un.	Código	EAN	P.V.P. (€)
5 Pré-filtros + filtro	EK7301WS EK8100WS DPC7331 DPC8132	1	957173190	-	19,00
5 Pré-filtros, filtro e caixa de pó	EK7651H	1	195599-9	0088381376884	65,00

Óleos



Descrição	Un.	Código	EAN	P.V.P. (€)
Óleo de motor 4T (220 ml) EK7651H	1	195532-1	0088381401937	7,45

Bomba de pressão



Modelos	Un.	Código	EAN	P.V.P. (€)
DPC7331 DPC8132 EK6100 EK7651H 4101RH	1	957802600	4002829128633	406,00

Kit de água para EK7651

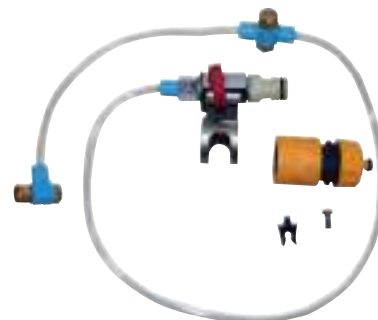

Modelo	Un.	Código	EAN	P.V.P. (€)
EK7651	1	195534-7	3240890392091	26,00



Pé com rodas



Modelos	Un.	Código	EAN	P.V.P. (€)
EK8100WS EK7301WS	1	394114272	-	60,00

Carrinhos de transporte



Tipo	Modelo	Un.	Código	EAN	P.V.P. (€)
DT4000	EK7651H	1	196354-2	0088381430517	922,00
DT2010	DPC6430 DPC7331 DPC8132 EK7301WS EK8100WS	1	197980-0	-	922,00



Acessórios para DCC501



191M48-2

140Y22-9

140Y23-7

127750-3

126738-0



Capaz de cortar a seco como molhado, trocando o protetor. Cortes em pedra, alvenaria, ladrilhos, betão e muito mais.



Descrição	Un.	Código	EAN	P.V.P. (€)
Kit de água completo	1	191M48-2	0088381575003	51,00
Tubo de água completo	1	140Y23-7	-	6,95
Adaptador de reservatório de água	1	140Y22-9	-	7,95
Depósito de água	1	140Y25-3	-	3,65
Caixa de pó	1	127750-3	-	13,15
Saco de pó	1	126738-0	0088381589802	6,00

Abrasivo lixas



Lixadoras orbitais

Lixas para BO4556



- Excelente desempenho de lixamento em aplicações profissionais.
- Aplicações: lixamento de madeira, ferro e madeira pintada. Óxido de alumínio.
- Com grão semiaberto e revestimento de resina sobre cola.

Medida (mm)	Grão	Un.	Código	EAN	P.V.P. (€)
114 x 140	40	10	P-36398	0088381972109	3,85
	60		P-32904	0088381961066	3,35
	80		P-36407	0088381972116	3,35
	100		P-32910	0088381961073	3,10
	120		P-32926	0088381961080	3,10
	150		P-32932	0088381961097	2,85
	180		P-36413	0088381972123	3,10
	240		P-36429	0088381972130	3,10

Lixas para BO4566

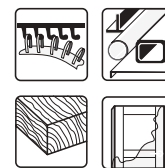
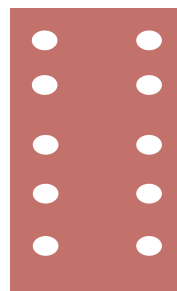

- Lixa de grão aberto de corindo com revestimento duplo de resina.
- Aplicações: lixamento de madeira seca, pintada ou envernizada.
- Também para metal. Perfeito para trabalhos de marcenaria e carroçaria. Orifícios de aspiração 5 + 5.

Medida (mm)	Grão	Un.	Código	EAN	P.V.P. (€)
100 x 240	40	10	P-42868	0088381970730	6,20
	60		P-42874	0088381970747	6,20
	80		P-42880	0088381970754	5,90
	100		P-42896	0088381970761	5,90
	120		P-42905	0088381970778	5,90
	150		P-42911	0088381970785	5,65
	180		P-42927	0088381970792	5,65
	240		P-42933	0088381970808	5,65

- Especialmente concebidas para pintura.
- Excelente desempenho em aplicações profissionais.
- Aplicações: lixamento de tinta, verniz, madeira pintada...



Medida (mm)	Grão	Un.	Código	EAN	P.V.P. (€)
114 x 140	40	10	P-36516	0088381972222	4,65
	60		P-36522	0088381972239	4,10
	80		P-36538	0088381972246	4,10
	100		P-36544	0088381972253	4,10
	120		P-36550	0088381972260	4,10
	150		P-36566	0088381972277	4,10
	180		P-36572	0088381972284	4,10
	240		P-36588	0088381972291	4,10



Makita

Lixadoras orbitais

Lixas para BO4565

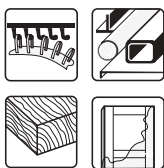

- Excelente desempenho de lixamento em aplicações profissionais.
- Aplicações: lixamento de madeira, ferro e madeira pintada.
- Óxido de alumínio extrarresistente e aderência por velcro. Orifícios de aspiração 3+3.

Medida (mm)	Grão	Un.	Código	EAN	P.V.P. (€)
114 x 102	40	10	P-33087	0088381961240	4,65
	60		P-33093	0088381961257	4,65
	80		P-33102	0088381961264	4,65
	100		P-33118	0088381961271	4,65
	120		P-33124	0088381961288	4,10
	150		P-33130	0088381961295	4,10
	180		P-33146	0088381961301	4,10
	240		P-33152	0088381961318	4,10
	320		P-33168	0088381961325	4,10

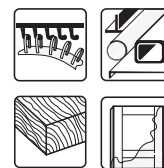

- Para uso com a maioria das lixadoras tipo delta com base triangular.
- Aplicações: lixamento de madeira, metal. Ideal para esquinas e lixamento de acabamento.
- Lixa triangular com aderência por velcro e 6 orifícios de aspiração.

Medida (mm)	Grão	Un.	Código	EAN	P.V.P. (€)
93 x 93 x 93	40	10	P-33255	0088381961417	3,85
	60		P-33261	0088381961424	3,85
	80		P-33277	0088381961431	3,85
	100		P-33283	0088381961448	3,60
	120		P-33299	0088381961455	3,60
	150		P-33308	0088381961462	3,60
	180		P-33314	0088381961479	3,60
	240		P-33320	0088381961486	3,60
	320		P-33336	0088381961493	3,60



- Especialmente concebidas para pintura. Excelente desempenho em aplicações profissionais. 6 orifícios de aspiração.
- Aplicações: lixamento de tinta, verniz, madeira pintada.

Medida (mm)	Grão	Un.	Código	EAN	P.V.P. (€)
114 x 102	40	10	P-35807	0088381964968	5,40
	60		P-35813	0088381964975	5,15
	80		P-35829	0088381964982	4,90
	100		P-35835	0088381964999	4,90
	120		P-35841	0088381965002	4,90
	150		P-35857	0088381966016	4,90
	180		P-35863	0088381966023	4,90
	240		P-35879	0088381966030	4,90
	320		P-35885	0088381966047	4,90



- Especialmente concebidas para pintura. Para uso com a maioria das lixadoras tipo delta com base triangular. 6 orifícios de aspiração.
- Excelente desempenho em aplicações profissionais.
- Aplicações: lixamento de tinta, verniz, madeira pintada.

Medida (mm)	Grão	Un.	Código	EAN	P.V.P. (€)
93 x 93 x 93	40	10	P-42684	0088381970556	4,10
	60		P-42690	0088381970563	3,85
	80		P-42709	0088381970570	3,85
	100		P-42715	0088381970587	3,85
	120		P-42721	0088381970594	3,85
	150		P-42737	0088381970600	3,85
	180		P-42743	0088381970617	3,85
	240		P-42759	0088381970624	3,85
	320		P-42765	0088381970631	3,85

Lixadoras orbitais

Lixas para BO3700/9036/BO3711 - DBO380/DBO381

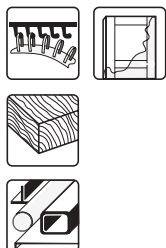

- Excelente desempenho de lixamento em aplicações profissionais.
- Aplicações: Lixamento de madeira, ferro e madeira pintada. Perfurações 4 + 4.

Medida (mm)	Grão	Un.	Código	EAN	P.V.P. (€)
93 x 185	40	10	P-31871	0088381960038	5,15
	60		P-31887	0088381960045	4,65
	80		P-31893	0088381960052	4,65
	100		P-31902	0088381960069	4,65
	120		P-35891	0088381966054	4,65
	150		P-35900	0088381966061	4,65
	180		P-35916	0088381966078	4,65
	240		P-35922	0088381966085	4,65



- Excelente desempenho de lixamento em aplicações profissionais.
- Lixa de grão aberto de corindo com revestimento duplo de resina.
- Ideal para lixar madeira seca, pintada ou envernizada.
- Também adequada para metal. Perfeita para trabalhos de marcenaria e carroçaria.

Medida (mm)	Grão	Un.	Código	EAN	P.V.P. (€)
93 x 228	40	10	P-36136	0088381966290	3,10
	60		P-32948	0088381961103	2,85
	80		P-36142	0088381966306	2,85
	100		P-32954	0088381961110	2,85
	120		P-36158	0088381966313	2,85
	150		P-32960	0088381961127	2,30



- Excelente desempenho de lixamento em aplicações profissionais.
- Lixa de grão aberto de corindo com revestimento duplo de resina.
- Ideal para lixar madeira seca, pintada ou envernizada. Também adequada para metal.
- Perfeita para trabalhos de marcenaria e carroçaria.
- Perfurações 4 + 4.

Medida (mm)	Grão	Un.	Código	EAN	P.V.P. (€)
93 x 228	40	10	P-31837	0088381959995	3,60
	60		P-31843	0088381960007	3,35
	80		P-31859	0088381960014	3,35
	100		P-31865	0088381960021	3,35
	120		P-36011	0088381966177	3,35
	150		P-36027	0088381966184	3,35
	180		P-36033	0088381966191	3,35
	240		P-36049	0088381966207	3,35



Makita

Lixadoras orbitais

Lixas para BO4900V/9046/BO4901

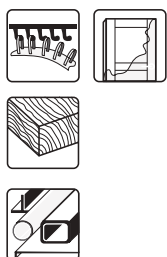

- Excelente desempenho de lixamento em aplicações profissionais.
- Lixa de grão aberto de corindo com revestimento duplo de resina.
- Ideal para lixar madeira seca, pintada ou envernizada.
- Também adequada para metal.
- Perfeita para trabalhos de marcenaria e carroçaria.
- Perfurações 5 + 5.

Medida (mm)	Grão	Un.	Código	EAN	P.V.P. (€)
115 x 229	40	10	P-33174	0088381961332	6,45
	60		P-33180	0088381961349	6,20
	80		P-33196	0088381961356	6,20
	100		P-33205	0088381961363	6,20
	120		P-33211	0088381961370	6,20
	180		P-33233	0088381961394	5,90
	240		P-33249	0088381961400	5,90

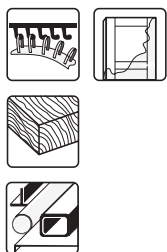

- Lixa de alta resistência. Excelente desempenho de lixamento em aplicações profissionais.
- Lixa de grão aberto de corindo com revestimento duplo de resina.
- Ideal para lixar madeira seca, pintada ou envernizada. Também adequada para metal.
- Perfeita para trabalhos de marcenaria e carroçaria.
- Perfurações 5 + 5 + 2 + 2.

Medida (mm)	Grão	Un.	Código	EAN	P.V.P. (€)
115 x 229	40	10	P-43022	0088381970891	7,20
	60		P-43038	0088381970907	6,70
	80		P-43044	0088381970914	6,45
	100		P-43050	0088381970921	6,20
	120		P-43066	0088381970938	6,20
	150		P-43072	0088381970945	5,65
	180		P-43088	0088381970952	6,20
	240		P-43094	0088381970969	6,20



- Excelente desempenho de lixamento em aplicações profissionais.
- Lixa de grão aberto de corindo com revestimento duplo de resina.
- Ideal para lixar madeira seca, pintada ou envernizada.
- Também adequada para metal.
- Perfeita para trabalhos de marcenaria e carroçaria.
- Perfurações 5 + 5 + 2 + 2.

Medida (mm)	Grão	Un.	Código	EAN	P.V.P. (€)
115 x 280	40	10	P-33009	0088381961165	4,40
	60		P-33015	0088381961172	4,10
	80		P-33021	0088381961189	4,10
	100		P-33037	0088381961196	4,10
	120		P-33043	0088381961202	4,10
	150		P-33059	0088381961219	4,10
	180		P-33065	0088381961226	4,10
	240		P-33071	0088381961233	3,85



- Excelente desempenho de lixamento em aplicações profissionais.
- Lixa de grão aberto de corindo com revestimento duplo de resina.
- Ideal para lixar madeira seca, pintada ou envernizada.
- Também adequada para metal.
- Perfeita para trabalhos de marcenaria e carroçaria.

Medida (mm)	Grão	Un.	Código	EAN	P.V.P. (€)
115 x 280	40	10	P-36267	0088381966429	4,10
	60		P-32976	0088381961134	3,85
	80		P-36273	0088381966436	3,85
	100		P-32982	0088381961141	3,85
	120		P-36289	0088381966443	3,85
	150		P-32998	0088381961158	3,10

Lixadoras orbitais

Rolos de lixa



- Para uso geral. Adequada para madeira, metal, tinta e verniz.
- Rolo de 5 m.
- Ideal para lixadoras orbitais.
- Adequado como lixa manual.

Largura (mm)	Grão	Comprimento (m)	Un.	Código	EAN	P.V.P. (€)
120	40	5	1	P-38102	0088381973816	8,00
	60			P-38118	0088381973823	6,20
	80			P-38124	0088381973830	5,40
	100			P-38130	0088381973847	5,15
	120			P-38146	0088381973854	5,15
	180			P-38152	0088381973861	5,15
	240			P-38168	0088381973878	5,15
	320			P-38174	0088381973885	5,15
	400			P-38180	0088381973892	4,10



- Para uso geral. Adequada para madeira, metal, tinta e verniz.
- Rolo de 50 m.
- Ideal para lixadoras orbitais.
- Adequado como lixa manual.

Largura (mm)	Grão	Comprimento (m)	Un.	Código	EAN	P.V.P. (€)
120	40	50	1	P-38196	0088381973908	55,00
	60			P-38205	0088381973915	45,00
	80			P-38211	0088381973922	39,00
	100			P-38227	0088381973939	36,00
	120			P-38233	0088381973946	36,00
	180			P-38249	0088381973953	36,00
	240			P-38255	0088381973960	36,00
	320			P-38261	0088381973977	36,00
	400			P-38277	0088381973984	36,00

Bases para lixadoras orbitais



158324-9



158326-5



158325-7



Base de borracha do modelo BO3711

Modelo	Tipo	Medida	Un.	Código	EAN	P.V.P. (€)
BO4556 BO4565 BO4566	Quadrada Borracha*	112 x 102	1	158324-9	0088381413596	3,00
	Triangular Velcro	112 x 190	1	158325-7	3240890999597	8,00
	Retangular Velcro	100 x 164	1	158326-5	3240890999580	7,00
BO3700 BO3711	Borracha	93 x 185	1	140441-9	-	4,20
	Velcro	93 x 185	1	194930-6	0088381355759	14,40 **
BO4900V BO4901	Borracha	115 x 229	1	193523-6	0088381164719	15,00
	Velcro	115 x 229	1	193521-0	0088381164702	28,00
9046	Velcro	115 x 229	1	162172-0	3240890063304	37,00

* Para trocar a base de borracha de BO4556 à base de velcro triangular ou retangular, é necessário utilizar a base 450068-0.
** Esta base é considerada um acessório.

Lixadeiras rotorbitais

Lixas para BO5040/BO5041/DBO180

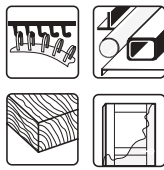

- Lixa de grão semiaberto de óxido de alumínio com revestimento de resina fenólica.
- Ideal para trabalhos em madeira, plástico, chapa metálica, madeira envernizada e metal pintado.
- 8 perfurações.

Ø (mm)	Grão	Un.	Código	EAN	P.V.P. (€)
125	40	10	P-43533	0088381971409	5,15
	60		P-43549	0088381971416	4,90
	80		P-43555	0088381971423	4,65
	100		P-43561	0088381971430	4,65
	120		P-43577	0088381971447	4,65
	180		P-43583	0088381971454	4,65
	240		P-43599	0088381971461	4,65
	320		P-43608	0088381971478	4,40
	400		P-43614	0088381971485	4,40

Lixas para BO6030/BO6050

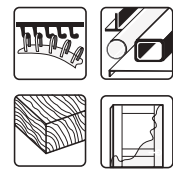

- Lixa de grão semiaberto de óxido de alumínio com revestimento de resina fenólica.
- Ideal para trabalhos em madeira, plástico, chapa metálica, madeira envernizada e metal pintado.
- 8 perfurações.

Ø (mm)	Grão	Un.	Código	EAN	P.V.P. (€)
150	40	10	P-31918	0088381960076	7,20
	60		P-31924	0088381960083	6,95
	80		P-31930	0088381960090	6,70
	100		P-31946	0088381960106	6,45
	120		P-31952	0088381960113	6,45
	150		P-31968	0088381960120	6,45
	180		P-31974	0088381960137	6,45
	220		P-31980	0088381960144	6,45
	240		P-31996	0088381960151	6,45
	320		P-32007	0088381960168	6,45
	400		P-32013	0088381960175	6,45

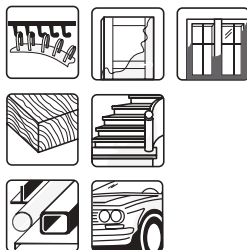

- Especialmente concebidas para pintura.
- Excelente desempenho em trabalhos em automóveis.
- Revestimento antiestático que evita obstruções na lixa para um acabamento mais fino.
- 8 perfurações.

Ø (mm)	Grão	Un.	Código	EAN	P.V.P. (€)
125	40	10	P-33342	0088381961509	4,65
	60		P-33358	0088381961516	4,40
	80		P-33364	0088381961523	4,10
	100		P-33370	0088381961530	4,10
	120		P-33386	0088381961547	4,10
	180		P-33392	0088381961554	4,10
	240		P-33401	0088381961561	4,10
	320		P-33417	0088381961578	4,10
	400		P-33423	0088381961585	4,10

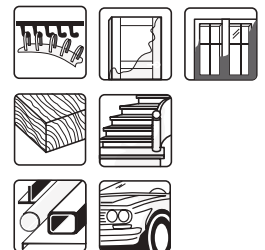

- Especialmente concebidas para pintura.
- Excelente desempenho em trabalhos em automóveis.
- Revestimento antiestático que evita obstruções na lixa para um acabamento mais fino.
- 8 perfurações.

Ø (mm)	Grão	Un.	Código	EAN	P.V.P. (€)
150	40	10	P-37839	0088381973540	6,95
	60		P-37845	0088381973557	6,45
	80		P-37851	0088381973564	6,20
	100		P-37867	0088381973571	5,90
	120		P-37873	0088381973588	5,90
	150		P-37889	0088381973595	5,90
	180		P-37895	0088381973601	5,90
	220		P-37904	0088381973618	5,90
	240		P-37910	0088381973625	5,90
	320		P-37926	0088381973632	5,90
	400		P-37932	0088381973649	5,90

Lixadoras rotorbitais e de disco

Caixas de discos de velcro perfurados de 150 mm

- Gama de lixas de óxido de alumínio para lixadoras rotorbitais de 150 mm.
- Embalagens de 50 e 100 unidades.
- Ideais para utilizadores com elevado consumo de lixas.
- Perfeitas para o acabamento em fibra de vidro, madeira, metal e chapa de automóveis.
- Perfurações 8 + 6.

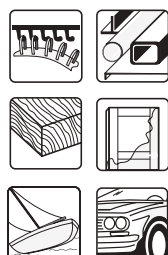

Ø (mm)	Grão	Un.	Código	EAN	P.V.P. (€)
150	40	50	B-39300	0088381434041	29,00
	60		B-39316	0088381434058	27,00
	80	100	B-39322	0088381434065	48,00
	100		B-39338	0088381434072	45,00
	120		B-39344	0088381434089	43,00
	240		B-39350	0088381434096	42,00
	320		B-39366	0088381434102	42,00
	360		B-39372	0088381434119	42,00
	400		B-39388	0088381434126	42,00
	500		B-39394	0088381434133	42,00
	600	B-39403	0088381434140	42,00	
	800	B-39419	0088381434157	42,00	
	1000	B-39425	0088381434164	42,00	

Discos de lixa para lixadora DSL800 de 225 mm

- Discos especiais para trabalhos em paredes divisórias secas.
- Grão cerâmico com resina.
- Revestimento especial, evita a obstrução e o desgaste.
- Mais durável que um disco abrasivo.



Ø (mm)	Grão	Un.	Código	EAN	P.V.P. (€)
225	40	25	q	0088381545891	32,00
	80		B-68395	0088381545907	31,00
	120		B-68404	0088381545914	27,00
	180		B-68410	0088381545921	27,00
	320		B-68426	0088381545938	27,00

Discos de lixa 115 mm/125 mm/180 mm

- Discos de fibra excelentes para remover vernizes e tintas em madeira e metal, bem como correções em soldaduras.



Ø (mm)	Grão	Un.	Código	EAN	P.V.P. (€)
115	24	5	P-00860	0088381918787	4,20
	40		P-00882	0088381918800	5,50
	60		P-00907	0088381918824	5,50
	80		P-00913	0088381918831	5,50
	120		P-00935	0088381918848	5,80
125	24		P-00957	0088381922203	5,00
	40		P-00979	0088381922227	6,30
	60		P-00985	0088381922234	6,30
	80		P-00991	0088381922241	6,55
	100		P-01002	0088381922258	6,85
180	120		P-01018	0088381922265	6,85
	24		P-01030	0088381918879	7,90
	40		P-01052	0088381918893	8,15
	60		P-01074	0088381918916	8,15
	80		P-01080	0088381918923	8,15
	100	P-01096	0088381918930	7,60	
	120	P-01105	0088381918947	7,60	

Lixas para lixadoras de disco de 180 mm

- Lixa de óxido de alumínio de grão aberto com revestimento de resina e cola à base de látex.
- Excelente desempenho em trabalhos em automóveis.
- Perfeita para trabalhos em madeira não tratada, madeira envernizada, carroçaria.
- Especialmente concebida para lixar tinta.

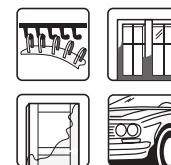

Ø (mm)	Grão	Un.	Código	EAN	P.V.P. (€)
180	40	10	P-33439	0088381961592	10,30
	60		P-38037	0088381973748	8,50
	80		P-33445	0088381961608	8,00
	100		P-38043	0088381973755	7,70
	120		P-33451	0088381961615	7,70
	240		P-38059	0088381973762	7,70
	320	P-38065	0088381973779	7,70	

Pratos de velcro para lixadoras/polidoras de disco



197925-8

PO6000C



Pratos de borracha para lixadoras/polidoras de disco



Descrição	Ø (mm)	Un.	Código	EAN	P.V.P. (€)
Requer porca	115	1	743015-1	0088381102094	8,85
	120		743025-8	0088381101295	4,65
	125		743016-9	0088381109017	9,55
	170		743008-8	0088381109055	23,00
5/8"	170		743012-7	0088381101233	15,45

Porca para pratos de borracha



Descrição	Un.	Código	EAN	P.V.P. (€)
M14	1	224515-5	0088381116190	5,15

M14

743060-6



DSL800

199939-3



Descrição	Ø (mm)	Un.	Código	EAN	P.V.P. (€)
PO6000C	100	1	197925-8	00883811468367	58,00
	125		197922-4	00883811468343	57,00
	150		197928-2	00883811468381	57,00
M14	115	1	743060-6	0088381156967	15,45
	117		P-21777	0088381948876	12,35
	165		743053-3	0088381146104	19,55
DSL800	Macio	210	199939-3	0088381546157	54,00
	Médio		199940-8	0088381546164	61,00
	Duro		199938-5	0088381546140	59,00



Lixas para lixadoras de cinta

- Lixa de óxido de alumínio com grão fechado e revestimento duplo de resina sobre base de tecido.
- Produto de grande resistência concebido especialmente para lixadoras de cinta.
- Adequadas para todos os tipos de madeira e metal.



Modelos	Medida (mm)	Grão	Un.	Código	EAN	P.V.P. (€)
9910 9911	76 x 457	40	5	P-37091	0088381972802	9,25
		60		P-37100	0088381972819	9,00
		80		P-37116	0088381972826	9,00
		100		P-37122	0088381972833	9,00
		120		P-37138	0088381972840	9,00
		150		P-37144	0088381972857	9,00
		240		P-37150	0088381972864	9,00



Modelo	Medida (mm)	Grão	Un.	Código	EAN	P.V.P. (€)
9903	76 x 533	40	5	P-37172	0088381972888	9,80
		60		P-37188	0088381972895	9,25
		80		P-37194	0088381972901	8,75
		100		P-37203	0088381972918	8,50
		120		P-37219	0088381972925	8,50
		150		P-37225	0088381972932	8,50
		240		P-37231	0088381972949	8,50



Modelos	Medida (mm)	Grão	Un.	Código	EAN	P.V.P. (€)
9920 9924DB	76 x 610	40	5	P-37312	0088381973021	10,80
		60		P-37328	0088381973038	10,30
		80		P-37334	0088381973045	9,80
		100		P-37340	0088381973052	9,00
		120		P-37356	0088381973069	9,00
		150		P-37362	0088381973076	9,00
		240		P-37378	0088381973083	9,00



Modelos	Medida (mm)	Grão	Un.	Código	EAN	P.V.P. (€)
9402 9403 9404	100 x 610	40	5	P-36887	0088381972598	12,90
		60		P-36893	0088381972604	11,85
		80		P-36902	0088381972611	11,85
		100		P-36918	0088381972628	11,85
		120		P-36924	0088381972635	11,85
		150		P-36930	0088381972642	11,85
		240		P-36946	0088381972659	11,85

Placas de grafite



Modelo	Un.	Código	EAN	P.V.P. (€)
9924DB	1	423036-6	0088381116398	2,20
9402		423029-3	0088381116367	2,80
9403		421648-9	0088381148191	3,50
9404		193201-8	0088381157056	7,30
9903		423315-2	0088381154291	2,35
9920		423316-0	0088381154307	2,85

Placas de cortiça

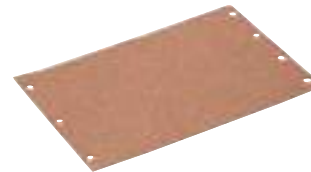

Modelo	Un.	Código	EAN	P.V.P. (€)
9404	1	193202-6	0088381157063	4,90
9903		423312-8	0088381154321	2,05
9402		421093-8	0088381123839	4,10
9924DB		423035-8	0088381152532	3,85
9403		421646-3	0088381148177	2,60
9901		423149-3	0088381126397	2,60
9920		423313-6	0088381154338	2,60

Placas de metal



Modelo	Un.	Código	EAN	P.V.P. (€)
9402	1	342328-3	0088381116244	2,85
9924DB		341705-6	0088381116268	3,35
9404		151751-9	0088381154284	8,00
9902 9903		151749-6	0088381154246	5,15
9920		151750-1	0088381154277	5,15
9403 (metal + cortiça)		150980-1	0088381148153	5,15
9903		344620-3	0088381148160	2,15
9910 9911		344586-7	0088381146791	2,60

Cintas de lixa de alta qualidade para 9032

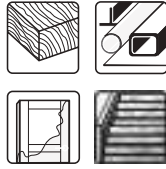
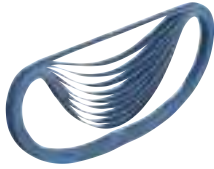

10 un.

Modelo	Medida (mm)	Grão	Un.	Código	EAN	P.V.P. (€)
9032	6 x 533	80	10	A-34534	0088381164450	20,10
		100		A-34540	0088381164467	19,05
		120		A-34556	0088381164474	18,00
	9 x 533	40		A-34447	0088381164382	21,00
		60		A-34453	0088381164399	21,00
		80		A-34469	0088381164405	19,05
		100		A-34475	0088381164412	16,50
		120		A-34481	0088381164429	16,50
	13 x 533	40		A-34562	0088381164481	23,00
		60		A-34578	0088381164498	23,00
		80		A-34584	0088381164504	22,00
		100		A-34590	0088381164511	22,00
		120	A-34609	0088381164528	19,05	

25 un.

Modelo	Medida (mm)	Grão	Un.	Código	EAN	P.V.P. (€)
9032	6 x 533	60	25	P-39394	0088381967266	30,00
	6 x 533	100		P-39419	0088381967280	30,00
	6 x 533	120		P-39425	0088381967297	30,00

Cintas de lixa de alta qualidade para 9031

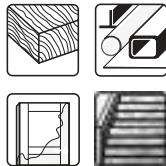

Modelo	Medida (mm)	Grão	Un.	Código	EAN	P.V.P. (€)
9031	30 x 533	40	5	P-36675	0088381972383	4,90
	30 x 533	60		P-36681	0088381972390	4,40
	30 x 533	80		P-36697	0088381972406	4,40
	30 x 533	100		P-36706	0088381972413	4,40
	30 x 533	120		P-36712	0088381972420	4,40
	30 x 533	150		P-36728	0088381972437	4,40
	30 x 533	240		P-36734	0088381972444	4,40

Cintas de lixa para LB1200F



Grão	Dimensões (mm)	Un.	Código	EAN	P.V.P. (€)
80	20 x 2240	1	B-42581	0088381440738	13,40
120	20 x 2240		B-42597	0088381440745	13,40

Cintas de lixa padrão para 9032

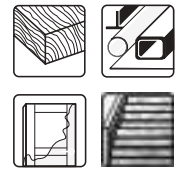
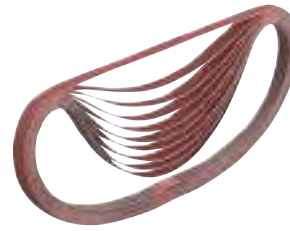

5 un.

Modelo	Medida (mm)	Grão	Un.	Código	EAN	P.V.P. (€)	
9032	6 x 533	40	5	P-43181	0088381971058	5,40	
		60		P-43197	0088381971065	5,40	
		80		P-43206	0088381971072	5,15	
		100		P-43212	0088381971089	5,15	
		120		P-43228	0088381971096	5,15	
		150		P-43234	0088381971102	5,15	
		240		P-43240	0088381971119	5,15	
		9 x 533		40	P-43256	0088381971126	6,20
				60	P-43262	0088381971133	6,20
				80	P-43278	0088381971140	5,90
	100			P-43284	0088381971157	5,90	
	120			P-43290	0088381971164	5,90	
	150			P-43309	0088381971171	5,90	
	240			P-43315	0088381971188	5,90	
	13 x 533			40	P-43321	0088381971195	8,00
				60	P-43337	0088381971201	7,70
				80	P-43343	0088381971218	7,45
		100		P-43359	0088381971225	7,20	
		120		P-43365	0088381971232	7,20	
		150		P-43371	0088381971249	7,45	
		240		P-43387	0088381971256	7,45	

Cinta de lixa especial vidro para 9031



Modelo	Medida (mm)	Grão	Un.	Código	EAN	P.V.P. (€)
9031	30 x 533	40	5	P-01395	0088381922302	11,35
	30 x 533	60		P-01404	0088381922319	11,35
	30 x 533	80		P-01199	0088381913928	10,30
	30 x 533	100		P-01208	0088381913935	10,30
	30 x 533	120		P-01214	0088381913942	10,30
	30 x 533	150		P-01220	0088381913959	10,30
	30 x 533	180		P-01236	0088381913966	10,30

Acessórios de polimento para PV301 e DPV300



743126-2

743124-6

Descrição	Grão	Un.	Código	EAN	P.V.P. (€)
Discos de lixa	A60	25	E-07412	0088381574044	44,00
	A80		E-07428	0088381574051	44,00
	A120		E-07434	0088381574068	44,00
	Z60		E-07440	0088381574075	44,00
	Z80		E-07456	0088381574082	44,00
Discos abrasivos para superfície	Grosso	25	E-07462	0088381574099	81,00
	Médio		E-07478	0088381574105	81,00
	Fino		E-07484	0088381574112	81,00
	Médio		E-07490	0088381574129	71,00
	Fino		E-07509	0088381574136	71,00
	Muito fino		E-07515	0088381574143	71,00
Adaptador	-	1	743126-2	-	5,25
Prato	-	1	743124-6	0088381587853	13,40



Adaptador de boina duplo



Descrição	Un.	Código	EAN	P.V.P. (€)
Adaptador de boina duplo	1	D-56960	0088381457620	2,15

Prato de velcro



191N90-9

191N91-7

191N92-5

743125-4

Descrição	Grão	Un.	Código	EAN	P.V.P. (€)
Esponja de velcro (grosseira)	80	25	191N90-9	0088381577045	9,55
Esponja de velcro (média)	80		191N91-7	0088381577052	11,85
Boina de lã com velcro	80		191N92-5	0088381577069	11,85
Prato de velcro	80		743125-4	0088381587860	35,00

Modelo	Descrição	Ø (mm)	Un.	Código	EAN	P.V.P. (€)
BO5030 BO5031 BO5040 BO5041	Macio (lixamento geral)	123	1	743081-8	0088381350044	30,00
	Duro (lixamento grosseiro)	150		196685-9	0088381438957	24,00
BO6040 BO6030	Macio (lixamento geral)	150		196684-1	0088381438940	28,00
	Super macio (lixamento fino)	150		196686-7	0088381438964	27,00
BO6050J	Duro (lixamento grosseiro)	150		197315-5	0088381461955	49,00
	Macio (lixamento geral)	150		197314-7	0088381461948	45,00
	Super macio (lixamento fino)	150	197316-3	0088381461962	49,00	
	Polimento	130	197317-1	0088381461979	45,00	

Boinas de lã dupla



Ø (mm)	Modelos	Un.	Código	EAN	P.V.P. (€)
230	9237CB	1	D-70873	0088381557771	17,45

Boinas de lã com velcro. Polimento de alto brilho



Ø (mm)	Un.	Código	EAN	P.V.P. (€)
100	1	197896-9	0088381468305	17,00
125		197897-7	0088381468329	14,95
150		199424-6	0088381534567	26,00
150		794560-9	0088381149365	22,00
180		192629-7	0088381140690	19,55

Boinas de lã



794176-0

Ø (mm)	Tipo	Un.	Código	EAN	P.V.P. (€)
100	Lã	1	794173-6	0088381103848	12,35
180	Cordeiro		794176-0	0088381117159	22,00

Feltro (com velcro)



Ø (mm)	Tipo	Un.	Código	EAN	P.V.P. (€)
100	Velcro	1	197895-1	0088381468282	27,00
125	Velcro		196152-4	0088381413572	24,00
150	Velcro		794618-4	0088381157841	18,50



Esponjas de velcro



D-70786



D-70792



P-21733

Ø (mm)	Tipo		Un.	Código	EAN	P.V.P. (€)
100	-	Lisa	1	197893-5	0088381468244	17,50
125	-	Lisa		794558-6	0088381149358	24,00
150	-	Lisa		197894-3	0088381468268	21,00
190	Grosseira	Lisa		D-70786	0088381556071	17,45
190	Médio	Lisa		D-70792	0088381556088	17,45
150	Grosseira	Lisa		P-21727	0088381948821	14,40
150	Fino	Lisa	P-21733	0088381948838	10,05	



100	Grosseira	Lisa	1	D-62505	0088381498142	4,60
125	Grosseira	Lisa		D-62511	0088381498159	6,50
150	Grosseira	Lisa		D-62527	0088381498166	7,65



100	Médio	Lisa	1	D-62533	0088381498173	4,60
125	Médio	Lisa		D-62549	0088381498180	6,50
150	Médio	Lisa		D-62555	0088381498197	7,65



100	Fino	Lisa	1	D-62561	0088381498203	4,60
125	Fino	Lisa		D-62577	0088381498210	6,50
150	Fino	Lisa		D-62583	0088381498227	7,65



100	Grosseira	Ondulada	1	D-62599	0088381498234	4,60
125	Grosseira	Ondulada		D-62608	0088381498241	6,50
150	Grosseira	Ondulada		D-62614	0088381498258	7,65



100	Médio	Ondulada	1	D-62620	0088381498265	4,60
125	Médio	Ondulada		D-62636	0088381498272	6,50
150	Médio	Ondulada		D-62642	0088381498289	7,65



100	Fino	Ondulada	1	D-62658	0088381498296	4,60
125	Fino	Ondulada		D-62664	0088381498302	6,50
150	Fino	Ondulada		D-62670	0088381498319	7,65

Placas perfuradoras

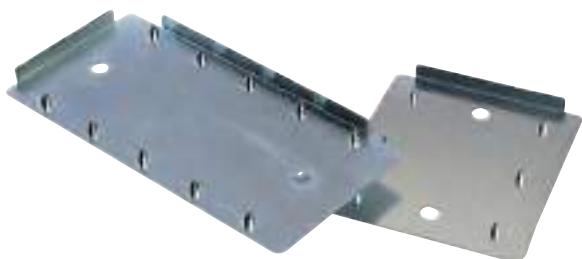

Modelo	Tipo	Un.	Código	EAN	P.V.P. (€)
BO4553	Metálica	1	413094-0	0088381201025	1,30
BO4556	Plástico	1	450066-4	0088381346085	0,90
BO3711	Metálica	1	192989-7	0088381151160	7,20
9046 BO4900V BO4901	Metálica	1	192523-3	0088381132282	21,00



Suporte + Saco de papel



Descrição	Modelo	Un.	Código	EAN	P.V.P. (€)
Suporte + Saco	BO4900V BO5020 BO5021 BO6030 BO9046	1	193294-5	0088381160247	12,35

Sacos de tecido



Descrição	Modelo	Un.	Código	EAN	P.V.P. (€)
Tecido vermelho (com adaptador)	9046	1	152456-4	0088381133548	20,10
Tecido vermelho (com adaptador)	BO3700 BO3711	1	151780-2	0088381156929	2,45
Tecido vermelho (sem adaptador) para 151518-5	BO4901 BO4900V BO6030	1	151517-7*	0088381150859	8,25
Tecido (com adaptador)	BO4556 BO4565 BO4566	1	135222-4	0088381435918	4,60

* Indicados para caixa de pó.

Sacos de papel e nylon



Descrição	Modelo	Un.	Código	EAN	P.V.P. (€)
Papel (11 cm)	BO3711 BO4556 BO4565 BO4566 BO5030 BO5031 BO5040 BO5041	5	194746-9*	0088381352017	5,15
Papel (15 cm)	BO4553	5	193712-3	0088381181730	6,25
Papel (longo)	BO4900V BO6030 9046	5	193293-7	0088381160254	7,60
Nylon (11 cm)	BO4556 BO4565 BO4566	1	168557-8*	3240890313324	2,50

Caixa de pó



Descrição	Modelo	Un.	Código	EAN	P.V.P. (€)
Com adaptador e saco de papel pequeno	BO5030 BO5031 BO5040 BO5041	1	135246-0	0088381403528	4,65
Com adaptador e saco de nylon	BO3711 DBO180	1	135327-0	0088381365611	6,20
Sem adaptador e saco	DBO380 DBO381	1	450770-5	-	2,40



Extensão para DSL800



Descrição	Un.	Código	EAN	P.V.P. (€)
Conjunto de cabo extensor	1	199937-7	0088381549370	175,00

Punhos

1

2



Modelo	Tipo	Descrição	Un.	Código	EAN	P.V.P. (€)
GV7000C PV7000C	1	Punho	1	152491-2	0088381131605	2,35
9227CB	2	Pega	1	416348-4	0088381201193	10,40
PO6000C	1	Punho	1	198043-5	0088381473033	8,75
DPO600	1	Punho	1	144163-3	0088381523769	3,25

Suporte de lixa para 9032



Descrição	Modelo	Un.	Código	EAN	P.V.P. (€)
Suporte de lixa de 6 mm	9032	1	125157-7	0088381164009	59,00
Suporte de lixa de 9 mm		1	125158-5	0088381164016	33,00
Suporte de lixa de 13 mm		1	125159-3	0088381164023	80,00

Protetores de plástico



Modelo	Descrição	Un.	Código	EAN	P.V.P. (€)
9565CLR	Protetor de plástico	1	417322-5	0088381156981	7,60
9227CB		1	417671-0	0088381169424	16,85
9237C		1	455291-2	3240890404916	8,80
SA5040C		1	453378-4	0088381538480	9,75
SA7000C		1	418529-6	0088381191975	3,00

Protetor de pó 9237C



Modelo	Descrição	Un.	Código	EAN	P.V.P. (€)
9237C	Evita a entrada de partículas grosseiras no motor	1	455288-1	3240890404909	2,85

Acessórios para polidoras



Modelo	Tipo	Descrição	Un.	Código	EAN	P.V.P. (€)
9227CB PV7000C SA7000C	A	Dispositivo centralizador para acessórios de velcro	1	262542-4	0088381142915	2,20

Suporte vertical



Modelos	Un.	Código	EAN	P.V.P. (€)
9032	1	193618-5	0088381173988	33,00

Grampos de aperto



Modelos	Un.	Código	EAN	P.V.P. (€)
9910 9911	2	192694-6	0088381145626	40,00

Nivelador



Modelos	Un.	Código	EAN	P.V.P. (€)
9902 9903	1	193070-7	0088381154369	94,00
9404	1	193072-3	0088381154383	95,00

Suporte



Modelos	Un.	Código	EAN	P.V.P. (€)
9402 9401	1	342332-2	0088381116350	3,85

Saco coletor de pó para lixadoras de cinta



Modelos	Un.	Código	EAN	P.V.P. (€)
9402	1	122297-2	0088381116299	10,85
9403	1	122562-9	0088381148184	13,20
9404 9920	1	122591-2	0088381154239	11,85
9911	1	122548-3	0088381146784	5,45
9924DB	1	122296-4	0088381116282	13,15

Suporte com guia lateral



Modelos	Un.	Código	EAN	P.V.P. (€)
9903 - 9920 - 9404	1	193055-3	0088381151955	81,00
9924DB	1	STEX122299	0088381116336	105,00

Defletor de ar para 9402



Modelos	Un.	Código	EAN	P.V.P. (€)
9402	1	503174	-	13,90

Multifunções



Acessórios para multifunções - Gama Starlock

STARLOCK

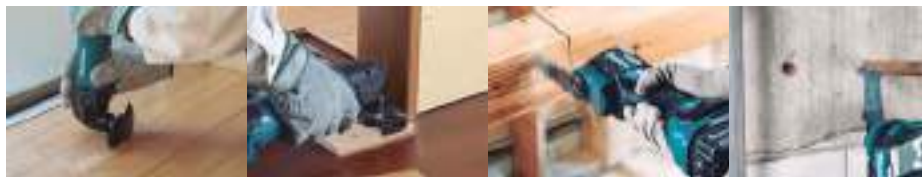

	Nome	Medida (mm)	Dentes por polegada	Material	Madeira					Metal				
					Dente curvo	Madeira	Contraplacado	Aglomerado	Laminado	Placa de gesso	Metal não ferroso	Chapa metálica	Inoxidável	Metal macio
	TMA064	85	18	BiM		✓	✓	✓	✓	✓	✓	✓		✓
	TMA046	100	15	BiM		✓	✓	✓	✓	✓	✓			✓
	TMA049	85	18	HCS		✓	✓	✓	✓					
	TMA045	85	18	BiM		✓	✓	✓	✓	✓	✓	✓		✓
	TMA048	65 x 40	20	BiM	✓	✓	✓	✓	✓	✓	✓	✓		✓
	TMA052	65 x 40	20	HCS	✓	✓	✓	✓	✓					
	TMA047	32 x 50	20	BiM	✓	✓	✓	✓	✓	✓	✓	✓		✓
	TMA051	32 x 50	18	HCS	✓	✓	✓	✓	✓					
	TMA055	65 x 40	14	BiM	✓	✓	✓	✓	✓	✓				
	TMA056	65 x 40	14	HCS	✓	✓	✓							
	TMA053	32 x 50	14	BiM	✓	✓	✓	✓	✓	✓				
	TMA050	24 x 50	18	HCS		✓	✓	✓	✓					
	TMA058	20 x 30	20	BiM		✓	✓	✓	✓	✓	✓	✓		✓
	TMA061	32 x 40	23	TC / HM		✓	✓	✓	✓	✓	✓	✓	✓	✓
	TMA059	32 x 50	20	BiM		✓	✓	✓	✓	✓	✓	✓		✓
	TMA057	10 x 30	20	HCS		✓	✓	✓	✓	✓	✓	✓		✓
	TMA060	20 x 40	23	TC / HM		✓	✓	✓	✓	✓	✓	✓	✓	✓
	TMA054	32 x 50	14	HCS	✓	✓	✓							
	TMA065	52 x 26	-	HCS										
	TMA066	52 x 40	-	HCS										
	TMA063	100	-	BiM										
	TMA067	28 x 40	-	HCS										
	TMA068	11 x 24	-	HCS										
	TMA075	32 x 30	-	TC # 50		✓				✓				
	TMA076	32 x 50	-	TC # 40		✓	✓							
	TMA077	32 x 50	-	TC # 100		✓	✓							
	TMA074	70	-	TC # 40						✓				
	TMA069	85	-	TC # 40						✓				
	TMA070	85	-	TC # 40						✓				
	TMA071	70	-	TC # 50						✓				
	TMA072	85	-	TC # 40						✓				
	TMA073	78	-	TC # 20		✓								



Multimaterial						Abrasivo		
Epóxi	Fibra de vidro	Linóleo	Adesivos	Material isolante	Material de vedação macio	Tijolo macio	Azulejos	Adesivos e argamassas
✓	✓							
✓	✓							
✓								
✓	✓							
✓	✓							
✓	✓							
✓	✓							
✓								
✓	✓							
✓	✓							
✓	✓							
✓	✓							
✓	✓							
✓	✓							
			✓					
			✓					
		✓	✓	✓				
					✓			
		✓	✓	✓				
✓	✓					✓	✓	✓
✓	✓					✓		✓
✓	✓					✓	✓	✓
✓	✓					✓	✓	✓
✓	✓					✓	✓	✓
✓	✓					✓	✓	✓
✓								✓



Acessórios para multifunções - Gama Starlock Máx

STARLOCK MAX



	Nome	Medida (mm)	Dentes por polegada	Material lâmina	Dente Curvo	Madeira					Metal			
						Madeira	Contraplacado	Aglomerado	Laminado	Placa de gesso	Metal não ferroso	Chapa metálica	Inoxidável	Metal macio
	MAM003	100	15	BiM		✓	✓	✓	✓		✓			✓
	MAM011	68	-	Diamante						✓				
	MAM009	68	-	TC # 50						✓				
	MAM010	68	-	TC # 30						✓				
	MAM014	100	-	TC # 40		✓	✓			✓	✓			✓
	MAM005	32	23	TC		✓	✓	✓	✓	✓	✓	✓	✓	✓
	MAM006	32	20	TC	✓	✓	✓	✓	✓	✓	✓	✓	✓	✓
	MAM004	32	18	HCS	✓	✓	✓	✓						
	MAM001	32	20	BiM	✓	✓	✓	✓	✓	✓	✓	✓		✓
	MAM002	52	18	BiM	✓	✓	✓	✓	✓	✓	✓	✓		✓
	MAM008	32	-	HCS										
	MAM007	32	-	HCS										
	MAM015	116	-	TC # 20		✓	✓	✓						
	MAM017	116	-	TC # 60		✓	✓	✓						



Multimaterial						Abrasivo		
Epóxi	Fibra de vidro	Linóleo	Adesivos	Material isolante	Material de vedação macio	Tijolo macio	Azulejos	Adesivos e argamassas
✓								
✓	✓					✓	✓	✓
✓	✓					✓	✓	✓
✓	✓					✓	✓	✓
✓	✓					✓		✓
✓	✓					✓		
✓	✓					✓		
✓	✓							
✓	✓							
				✓	✓			
					✓			
	✓							✓



Acessórios de corte

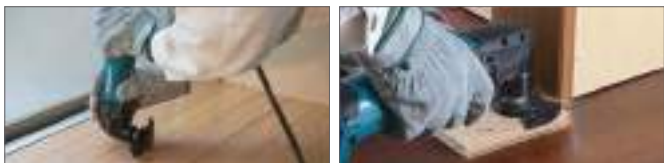

Lâmina de corte segmentada 85 STARLOCK

TMA064



- Metais não ferrosos, RFP, PVC.
- Adequado para esquinas.
- Corte por imersão em placas de gesso cartonado ou de fibrocimento.
- Realizar recortes em fibra de vidro (PRFV)/epóxi

Ø (mm)	Material/Indicado para	Un.	Código	EAN	P.V.P. (€)
85	BiM - TiN, Multimaterial	1	B-64973	0088381536479	23,00

Lâmina de corte segmentada 100 STARLOCK

TMA046



- Madeira e metal.
- Adequado para cortes rentes profundos.
- Armações da porta.
- Parquet/pavimento laminado.

Ø (mm)	Material/Indicado para	Un.	Código	EAN	P.V.P. (€)
100	BiM, Madeira e Metal	1	B-64808	0088381536301	24,00

Lâmina de corte segmentada 85 STARLOCK

TMA049



- Cortes por imersão em madeira maciça.
- Adequado para cortes rentes profundos.
- Tubo de PVC.

Ø (mm)	Material/Indicado para	Un.	Código	EAN	P.V.P. (€)
85	HCS/Madeira	1	B-64836	0088381536332	14,40

Lâmina de corte segmentada 85 STARLOCK

TMA045



- Madeira e metal.
- Adequado para cortes rentes profundos.
- Armações da porta.
- Parquet/pavimento laminado.

Ø (mm)	Material/Indicado para	Un.	Código	EAN	P.V.P. (€)
85	BiM, Madeira e Metal	1	B-64799	0088381536295	17,00

Acessórios de corte por imersão

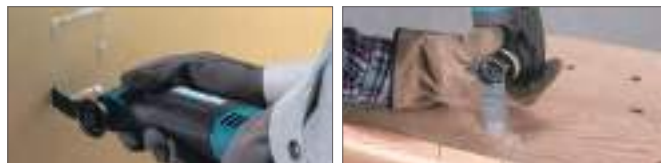

Lâmina de imersão 65 STARLOCK

TMA048



- Madeira e pregos.
- Armações da porta.
- Cortes por imersão em painéis laminados.

Tamanho (mm)	Material/Indicado para	Un.	Código	EAN	P.V.P. (€)
65 x 40	BiM, Madeira e Metal	1	B-64820	0088381536325	18,00

Lâmina de imersão 65 STARLOCK

TMA052



- Madeira e metal.
- Adequado para cortes rentes profundos.
- Parquet/pavimento laminado.
- Cortes por imersão em madeira.

Tamanho (mm)	Material/Indicado para	Un.	Código	EAN	P.V.P. (€)
65 x 40	HCS, Madeira	1	B-64864	0088381536363	13,40

Lâmina de imersão 32 STARLOCK

TMA047



- Madeira e metal.
- Adequado para corte por imersão preciso.
- Corte por imersão em madeira dura.

Tamanho (mm)	Material/Indicado para	Un.	Código	EAN	P.V.P. (€)
32 x 50	BiM, Madeira e Metal	1	B-64814	0088381536318	12,90
32 x 50	BiM, Madeira e Metal (20 un.)	20	B-64814-20	0088381541213	211,00

Lâmina de imersão 32 STARLOCK

TMA051



- Recortes em mobiliário.
- Cortes profundos em madeira macia.
- Cortes por imersão em madeira macia.

Tamanho (mm)	Material/Indicado para	Un.	Código	EAN	P.V.P. (€)
32 x 50	HCS, Madeira	1	B-64858	0088381536356	11,35
32 x 50	HCS, Madeira (20 un.)	20	B-64858-20	0088381541220	130,00

Acessórios de corte por imersão

Lâmina de imersão 65



TMA055



- Recortes em mobiliário.
- Cortes rentes.
- Corte por imersão em painéis laminados ou de madeira dura.



Tamanho (mm)	Material/Indicado para	Un.	Código	EAN	P.V.P. (€)
65 x 40	BiM, Madeira	1	B-64892	0088381536394	17,50

Lâmina de imersão 65



TMA056



- Recortes em mobiliário.
- Cortes rentes.
- Corte por imersão em painéis laminados ou madeira.



Tamanho (mm)	Material/Indicado para	Un.	Código	EAN	P.V.P. (€)
65 x 40	HCS, Madeira	1	B-64901	0088381536400	14,40

Lâmina de imersão 32



TMA053



- Madeira dura.
- Recortes em mobiliário.
- Cortes por imersão em madeira dura e painéis laminados.



Tamanho (mm)	Material/Indicado para	Un.	Código	EAN	P.V.P. (€)
32 x 50	BiM, Madeira	1	B-64870	0088381536370	11,60
32 X 50	BiM, Madeira	5	B-64870-5	-	58,00
32 x 50	BIM, Madeira	20	B-64870-20	0088381541237	211,00

Lâmina de imersão 24



TMA050



- Recortes em mobiliário.
- Cortes rentes em madeira. Cortes profundos em madeira macia.
- Cortes por imersão em madeira macia.



Tamanho (mm)	Material/Indicado para	Un.	Código	EAN	P.V.P. (€)
24 x 50	HCS, Madeira	1	B-64842	0088381536349	8,00
24 x 50	HCS, Madeira	1	B-64842-5	0088381536349	41,00



Lâmina de imersão 20



TMA058



- Metal. Adequado para corte rente em pregos ou tubos de cobre.
- Cortes em rodapés.



Tamanho (mm)	Material/Indicado para	Un.	Código	EAN	P.V.P. (€)
20 x 30	BiM, Metal	1	B-64923	0088381536424	8,75

Lâmina de imersão 32



TMA061



- Corte de aço inoxidável.
- Adequado para corte rente em parafusos e pregos temperados.
- Corte de fibra de vidro.



Tamanho (mm)	Material/Indicado para	Un.	Código	EAN	P.V.P. (€)
32 x 40	TC/HM, Metal	1	B-64951	0088381536455	23,00

Lâmina de imersão 32



TMA059



- Cortes em rodapés.
- Metal. Adequado para corte rente em pregos ou tubos de cobre.



Tamanho (mm)	Material/Indicado para	Un.	Código	EAN	P.V.P. (€)
32 x 50	BiM, Metal	1	B-64939	0088381536431	11,35

Lâmina de imersão 10



TMA057



- Metal. Adequado para corte rente em pregos.
- Cortes por imersão em placas de gesso cartonado.
- Cortes em rodapés.



Tamanho (mm)	Material/Indicado para	Un.	Código	EAN	P.V.P. (€)
10 x 30	HCS, Madeira	1	B-64917	0088381536417	7,70

Lâmina de imersão 20



TMA060



- Corte de aço inoxidável.
- Adequado para corte rente em parafusos e pregos temperados.
- Corte de fibra de vidro.

Tamanho (mm)	Material/Indicado para	Un.	Código	EAN	P.V.P. (€)
20 x 40	TC/HM, Metal	1	B-64945	0088381536448	19,55

Lâmina de imersão 32



TMA054



- Recortes em mobiliário.
- Cortes por imersão em madeira.

Tamanho (mm)	Material/Indicado para	Un.	Código	EAN	P.V.P. (€)
32 x 50	HCS, Madeira	1	B-64886	0088381536387	11,35

Raspadores



Raspador rígido 52



TMA065



- Remover restos de alcatifa, betume...
- Eliminação de resíduos: Adesivo, argamassa e betão.

Tamanho (mm)	Material/Indicado para	Un.	Código	EAN	P.V.P. (€)
52 x 26	HCS	1	B-64989	0088381536486	9,00

Raspador flexível 52



TMA066



- Remoção de resíduos de tinta.
- Retirar juntas de silicone.
- Remoção de resíduos de adesivos de carpetes.

Tamanho (mm)	Material/Indicado para	Un.	Código	EAN	P.V.P. (€)
52 x 40	HCS	1	B-64995	0088381536493	9,25

Lâminas de corte



Lâmina segmentada de serra 100



TMA063



- Ideal para materiais de isolamento.
- Corte rente de poliestireno.
- Corte de materiais macios (alcatifa, couro...)

Ø (mm)	Material/Indicado para	Un.	Código	EAN	P.V.P. (€)
100	BiM	1	B-64967	0088381536462	23,00

Lâmina de corte 28



TMA067



- Cortar juntas de expansão macias.
- Retirar silicone de janelas.
- Recortar material isolante.

Tamanho (mm)	Material/Indicado para	Un.	Código	EAN	P.V.P. (€)
28 x 40	HCS	1	B-65006	0088381536509	15,95

Lâmina universal multicorte 11



TMA068



- Cortar juntas de expansão macias.
- Retirar silicone de janelas.
- Recortar material isolante.

Tamanho (mm)	Material/Indicado para	Un.	Código	EAN	P.V.P. (€)
11 x 24	HCS	1	B-65012	0088381536516	17,00



Limpeza e corte



Lâmina de limpeza HM 32



TMA075



Corte por imersão e raspagem em fibra de vidro.

- Remover o betume em cantos apertados ou juntas de cimento.

Tamanho (mm)	Material/Indicado para	Un.	Código	EAN	P.V.P. (€)
32 x 30	TC/HM Grão 50	1	B-65084	0088381536585	23,00

Lâmina de limpeza HM 32



TMA076



- Lixamento de verniz ou tinta em zonas de difícil acesso.
- Lixamento de madeira, compósito de madeira-plástico e epóxi.

Tamanho (mm)	Material/Indicado para	Un.	Código	EAN	P.V.P. (€)
32 x 50	TC/HM Grão 40	1	B-65090	0088381536592	21,00

Lâmina de limpeza HM 32



TMA077



- Lixamento de verniz ou tinta em zonas de difícil acesso.
- Lixamento de madeira, compósito de madeira-plástico e epóxi.

Tamanho (mm)	Material/Indicado para	Un.	Código	EAN	P.V.P. (€)
32 x 50	TC/HM Grão 100	1	B-65109	0088381536608	21,00

Lâmina de limpeza HM



TMA074



- Para levantar argamassa.
- Limpar as juntas dos azulejos do chão.
- Limpeza de juntas de esquinas com a ponta de carboneto de tungstênio.

Tamanho (mm)	Material/Indicado para	Un.	Código	EAN	P.V.P. (€)
70	TC/HM Grão 40	1	B-65078	0088381536578	36,00

Lâmina de limpeza HM 85



TMA069



- Limpeza de juntas em paredes e pisos.
- Pequenos cortes em azulejo macio.
- Realizar roços em betão poroso para cabos e tubagens.

Ø (mm)	Material/Indicado para	Un.	Código	EAN	P.V.P. (€)
85	TC/HM Grão 40	1	B-65028	0088381536523	26,00

Lâmina de corte e limpeza de diamante segmentada HM 85



TMA070



- Pequenos cortes em azulejo macio.
- Fazer roços em epóxi, fibra de vidro, pvc, porcelana.

Ø (mm)	Material/Indicado para	Un.	Código	EAN	P.V.P. (€)
85	TC/HM Grão 40	1	B-65034	0088381536530	42,00

Lâmina de corte e limpeza segmentada HM 70



TMA071



- Limpeza de juntas em paredes e pisos.
- Pequenos cortes em azulejo macio.
- Realizar roços em betão poroso para cabos e tubagens.

Ø (mm)	Material/Indicado para	Un.	Código	EAN	P.V.P. (€)
70	TC/HM Grão 50	1	B-65040	0088381536547	23,00

Lâmina de corte e limpeza segmentada HM 85



TMA072



- Limpeza de juntas em paredes e pisos.
- Pequenos cortes em azulejo macio.
- Realizar roços em betão poroso.

Ø (mm)	Material/Indicado para	Un.	Código	EAN	P.V.P. (€)
85	TC/HM Grão 40	1	B-65056	0088381536554	22,00

Lâmina de limpeza

Lâmina de limpeza TC HM 78 STARLOCK

TMA073



- Remover argamassa ou cola de azulejos.
- Limpar adesivos das carpetes.

Tamanho (mm)	Material/Indicado para	Un.	Código	EAN	P.V.P. (€)
78	TC/HM Grão 20	1	B-65062	0088381536561	22,00

Prato de lixa 93

STARLOCK

TMA078



Tamanho (mm)	Material/Indicado para	Un.	Código	EAN	P.V.P. (€)
93	Velcro	1	B-65115	0088381536615	11,35

Jogo de lâminas

Jogo de lâminas de imersão

TMA045 Lâmina de corte segmentada 85

TMA047 Lâmina de imersão 32

TMA053 Lâmina de imersão 32

TMA058 Lâmina de imersão 20



Tamanho (mm)	Material/Indicado para	Un.	Código	EAN	P.V.P. (€)
-	Cortes por imersão	4	B-67480	0088381541145	45,00

Jogo de lâminas para azulejos

TMA058 Lâmina de imersão 20

TMA065 Raspador rígido 52

TMA069 Lâmina de limpeza HM 85

TMA073 Lâmina de limpeza TC HM 78



Tamanho (mm)	Material/Indicado para	Un.	Código	EAN	P.V.P. (€)
-	Azulejo	4	B-67496	0088381541152	54,00



Tabela de aplicação - Lixas para multifunções

		Grão	Tinta	Verniz	Lacas	Gesso	Madeira	Madeira macia	Madeira dura	Contraplacado de madeira	Aglomerado/MDF	Fibra de vidro/Plásticos	Metal	Aço	Pedra	Mármore	Granito	Vidro	Metacrilato		
Madeira/long life	Grosso	60																			
		80																			
	Médio	100	-	-	-	-	✓✓	✓✓	✓✓	✓✓	✓	✓✓	✓	-	-	-	-	-	-	-	
		120																			
		180																			
Fino	240																				
Madeira	Grosso	60																			
		80																			
	Médio	100	-	-	-	-	✓✓	✓	✓✓	✓✓	✓	-	-	-	-	-	-	-	-	-	
		120																			
		150																			
Fino	180																				
	240																				
Tinta	Grosso	60																			
		80																			
	Médio	100	✓✓	✓✓	✓✓	✓✓	-	-	✓	-	-	✓	✓	-	-	-	-	-	-	-	
		120																			
		240																			
Fino	320																				
Pedra	Médio	120																			
	Fino	240	✓	✓✓	-	-	-	-	-	-	✓	-	-	✓	✓	✓	✓	✓	✓		
		400																			
		600																			
	Muito fino	1200																			



Lixas

Lixas para madeira

- Adequado para lixar madeira, madeira dura, aglomerado, painéis de construção e metal.



Medida (mm)	Tipo	Grão	Un.	Código	EAN	P.V.P. (€)
93 x 93 x 93	Madeira	60	10	B-21624	0088381401081	3,60
		80	10	B-21630	0088381401098	3,35
		100	10	B-22947	0088381403344	3,35
		120	10	B-21646	0088381401104	3,35
		150	10	B-22953	0088381403351	3,35
		180	10	B-21652	0088381401111	3,35
		240	10	B-21668	0088381401128	3,35
		60, 80, 120, 180, 240	10 (2 de cada)	B-21618	0088381401074	3,90

Lixas para tinta e verniz

- Adequadas para lixar tinta, verniz ou retificar.



Medida (mm)	Tipo	Grão	Un.	Código	EAN	P.V.P. (€)
93 x 93 x 93	Tinta	60	10	B-21680	0088381401142	3,85
		80	10	B-21696	0088381401159	3,85
		100	10	B-21705	0088381401166	3,85
		120	10	B-22969	0088381403368	3,85
		240	10	B-21711	0088381401173	3,85
		320	10	B-21727	0088381401180	3,85
		60, 80, 100, 240, 320	10 (2 de cada)	B-21674	0088381401135	4,10

Abrasivo de lã para remover ferrugem do metal e sujidade da madeira

- Adequado para remover ferrugem do metal e sujidade da madeira.



Medida (mm)	Tipo	Grão	Un.	Código	EAN	P.V.P. (€)
93 x 93 x 93	Lã	100	1	B-21808	0088381401265	3,10
		280	1	B-21799	0088381401258	3,10
		Sem grão	1	B-21814	0088381401272	3,10

Kit de aspiração



Modelo	Un.	Código	EAN	P.V.P. (€)
TM3000C	1	196022-7	0088381411493	5,15
TM3010C	1	199624-8	0088381545297	8,25
DTM51	1	199627-2	0088381545327	10,75
DTM52	1	191R02-6	0088381580564	11,20

Lixas para madeira dura, painéis e metal

- Adequado para trabalhos em madeira, plástico, metal em chapas, madeira envernizada e metal pintado.



Medida (mm)	Tipo	Grão	Un.	Código	EAN	P.V.P. (€)
93 x 93 x 93	Madeira dura	40	10	P-33255	0088381961417	3,85
		60	10	P-33261	0088381961424	3,85
		80	10	P-33277	0088381961431	3,85
		100	10	P-33283	0088381961448	3,60
		120	10	P-33299	0088381961455	3,60
		180	10	P-33314	0088381961479	3,60
		240	10	P-33320	0088381961486	3,60
		60, 80, 100, 120, 180	10 (2 de cada)	B-21559	0088381401012	4,10

Lixas para materiais duros como pedra, mármore ou vidro

- Adequado para lixamento grosseiro ou brilhante de materiais duros como pedra, mármore ou vidro.



Medida (mm)	Tipo	Grão	Un.	Código	EAN	P.V.P. (€)
93 x 93 x 93	Pedra	120	10	B-21749	0088381401203	3,85
		240	10	B-21755	0088381401210	3,85
		400	10	B-21761	0088381401227	3,85
		600	10	B-21777	0088381401234	3,60
		1200	10	B-21783	0088381401241	3,60
		120, 240, 400, 600, 1200	10 (2 de cada)	B-21733	0088381401197	4,10

Feltro para pré-polimento de superfícies sujas ou arranhadas

- Feltro para pré-polimento de superfícies sujas ou arranhadas.



Medida (mm)	Tipo	Grão	Un.	Código	EAN	P.V.P. (€)
93 x 93 x 93	Feltro	Duro	1	B-21820	0088381401289	3,10

Adaptador universal



Un.	Código	EAN	P.V.P. (€)
1	313248-8	0088381416528	2,60

STARLOCK MAX



Acessórios de corte

Lâm. de corte segmentada 100 STARLOCK MAX

MAM003



- Adequada para cortes retos longos, cortes profundos e largos em madeira e metal.
- Também pode cortar epóxi e fibra de vidro.

Tamanho (mm)	Material/Indicado para	Un.	Código	EAN	P.V.P. (€)
100 x 50	BiM, madeira e metal	1	B-66422	0088381539326	23,00

Acessórios de corte por imersão



Lâmina de imersão curva 32 STARLOCK MAX

MAM006



- Adequada para corte por imersão de precisão, corte profundo e rápido em vários materiais.
- Também pode cortar madeira, epóxi, fibra de vidro e betão poroso.

Tamanho (mm)	Material/Indicado para	Un.	Código	EAN	P.V.P. (€)
32 x 70	TC/HM, Multimaterial	1	B-66450	0088381539357	24,00

Lâmina de imersão 32 STARLOCK MAX

MAM005



- Adequada para corte por imersão, corte profundo e rápido em metal.
- Também pode cortar epóxi, fibra de vidro, betão poroso e madeira.

Tamanho (mm)	Material/Indicado para	Un.	Código	EAN	P.V.P. (€)
32 x 70	TC/HM, Metal	1	B-66444	0088381539340	23,00

Lâmina de imersão curva 32 STARLOCK MAX

MAM004



- Adequada para corte por imersão preciso, corte profundo e rápido em madeira.
- Não pode ser usada para cortar outros materiais.

Tamanho (mm)	Material/Indicado para	Un.	Código	EAN	P.V.P. (€)
32 x 80	HCS, Madeira	1	B-66438	0088381539333	10,05

Lâmina de imersão curva 52 STARLOCK MAX

MAM002



- Adequada para o corte por imersão de precisão, corte profundo e largo especialmente em madeira e metal.
- Também pode cortar epóxi e fibra de vidro.

Tamanho (mm)	Material/Indicado para	Un.	Código	EAN	P.V.P. (€)
52 x 70	BiM, madeira e metal	1	B-66416	0088381539319	13,90

Lâmina de imersão curva 32 STARLOCK MAX

MAM001



- Adequada para o corte por imersão de precisão, corte profundo e rápido especialmente em madeira e metal.
- Também pode cortar epóxi e fibra de vidro.

Tamanho (mm)	Material/Indicado para	Un.	Código	EAN	P.V.P. (€)
32 x 80	BiM, madeira e metal	1	B-66400	0088381539302	12,90

Lâminas de corte de juntas



Lâminas de diamante



Lâmina de corte de juntas 32 STARLOCK MAX

MAM008



- Adequada para corte de juntas macias, corte profundo e largo.
- Não é possível cortar noutro material.

Tamanho (mm)	Material/Indicado para	Un.	Código	EAN	P.V.P. (€)
32 x 55	HCS, juntas macias	1	B-66472	0088381539371	6,70

Lâm. de corte segmentada 68 STARLOCK MAX

MAM011



- Adequada para o recorte de ladrilhos de parede macios.
- Também pode cortar gesso, epóxi e fibra de vidro.

Tamanho (mm)	Material/Indicado para	Un.	Código	EAN	P.V.P. (€)
68 x 30	Diamante Grão 40, corte de ladrilhos e azulejos de parede	1	B-66519	0088381539418	38,00



Lâmina de corte de juntas 32 STARLOCK MAX

MAM007



- Adequada para corte de juntas macias, corte profundo e rápido.
- Não é possível cortar outros materiais.

Tamanho (mm)	Material/Indicado para	Un.	Código	EAN	P.V.P. (€)
32 x 70	HCS, juntas macias	1	B-66466	0088381539364	13,40

Lâminas de corte para azulejos



Lâm. de corte segmentada 68 STARLOCK MAX

MAM009



- Adequada para cortar juntas em azulejos de parede.
- Também pode cortar em gesso cartonado, epóxi e fibra de vidro.



Tamanho (mm)	Material/Indicado para	Un.	Código	EAN	P.V.P. (€)
68 x 10	TC/HM Grão 50, juntas de azulejos de parede	1	B-66494	0088381539395	28,00

Lâm. de corte segmentada 68 STARLOCK MAX

MAM010



- Adequada para cortar juntas em azulejos de parede.
- Capaz de cortar outros materiais como gesso cartonado, epóxi, fibra de vidro.



Tamanho (mm)	Material/Indicado para	Un.	Código	EAN	P.V.P. (€)
68 x 30	TC/HM Grão 30, juntas de azulejos de parede	1	B-66503	0088381539401	28,00

Lâm. de corte segmentada 100 STARLOCK MAX

MAM014



- Adequada para cortar juntas em azulejos de parede.
- Também pode ser cortado em madeira, epóxi e fibra de vidro.



Tamanho (mm)	Material/Indicado para	Un.	Código	EAN	P.V.P. (€)
100 x 50	TC/HM Grão 40, juntas de azulejos de parede	1	B-66547	0088381539449	27,00



Limpeza e corte



Lâmina de limpeza 116

STARLOCK MAX

MAM015



- Adequada para limpar azulejos de parede.
- Também pode limpar madeira e fibra de vidro.



Ø (mm)	Material/Indicado para	Un.	Código	EAN	P.V.P. (€)
116	TC/HM Grão 20, limpeza de azulejos	1	B-66553	-	21,00



Lâmina de limpeza 116

STARLOCK MAX

MAM017



- Adequada para limpar madeira.
- Também pode limpar derivados de madeira.



Ø (mm)	Material/Indicado para	Un.	Código	EAN	P.V.P. (€)
116	TC/HM Grão 60, limpeza de madeira	1	B-66575	0088381539470	21,00

Serras

- Circulares
- Esquadria
- Incisão

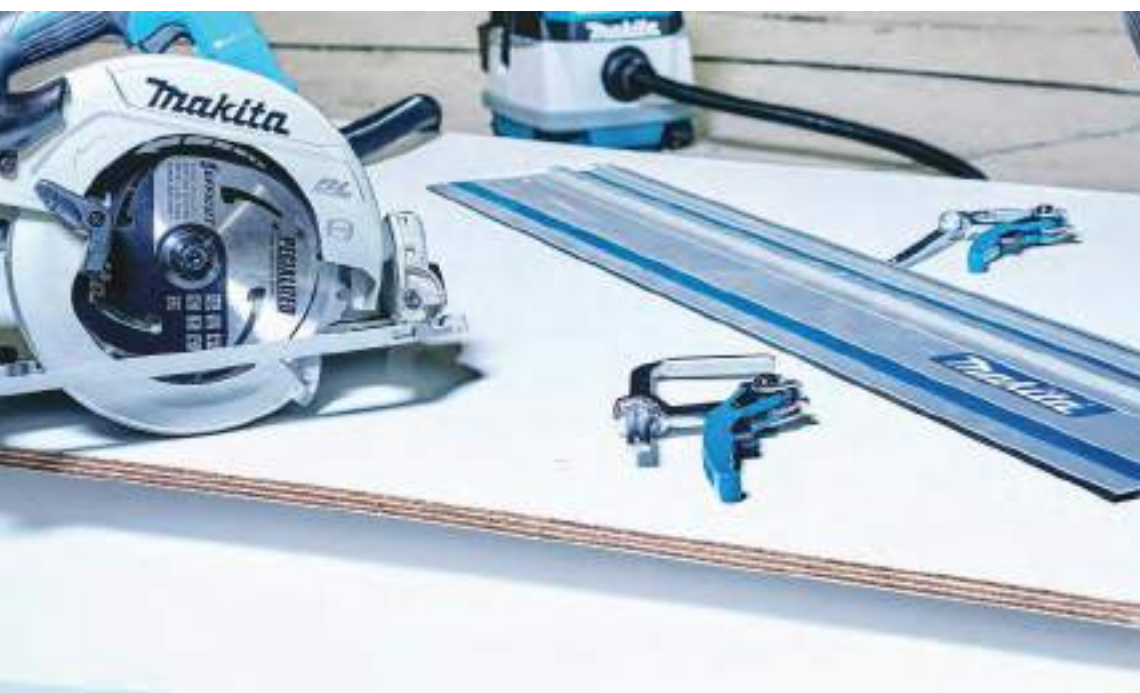

MFORCE™

SPECIALIZED

EFFICUT



Tipos de dentado

ATB

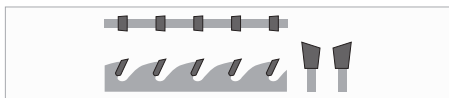

ATAF

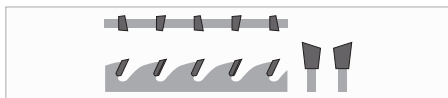

M-FORCE

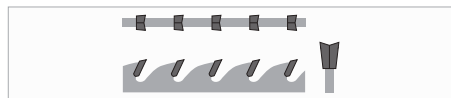

FTG

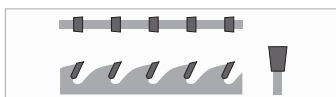

TCG

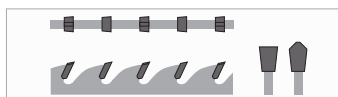

SMTCG

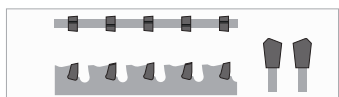

HI - ATB

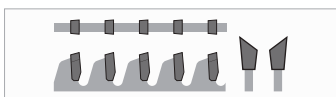

Tecnologia

Fenda a laser

Laser slit

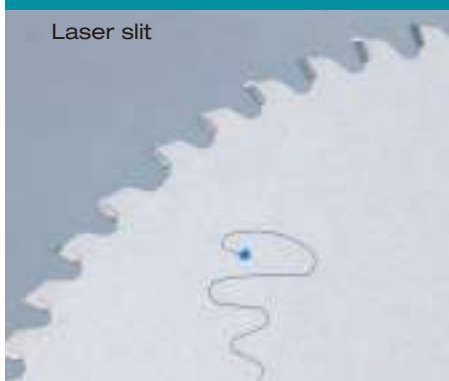

Reduz o ruído e as vibrações.

Revestido























O revestimento de PTFE (politetrafluoroetileno) reduz a acumulação de sujeira e diminui a resistência sobre o material.













Reforçado



O desenho de dente embutido aumenta a superfície de aderência para suportar trabalhos mais duros.

Tipos de discos para serras circulares, serras de esquadria e serras de incisão

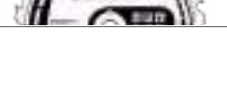
			85 mm	136 mm	165 mm	185 mm	190 mm	210 mm	235 mm	270 mm	355 mm
MAKFORCE			-	-	160 mm	170 mm	180 mm	230 mm	✓	✓	✓
SPECIALIZED REFORZADO			-	-	✓	✓	✓	✓	✓	✓	✓
MFORCE			-	-	✓	✓	-	-	✓	-	-
SPECIALIZED STANDARD			-	-	✓	✓	-	✓	✓	-	-
SPECIALIZED STANDARD economy			-	-	✓	✓	✓	-	✓	-	-
SPECIALIZED ALUMINIO			-	-	160 mm	-	✓	✓	✓	-	360 mm
SPECIALIZED CONSTRUCCION			-	-	-	-	✓	✓	✓	-	-
SPECIALIZED PANEL SANDWICH			-	-	✓	-	-	-	✓	✓	✓
SPECIALIZED MAQUINAS DE BATERIA			✓	✓	✓	-	✓	-	✓	-	-
SPECIALIZED INCISION			-	-	160 mm	-	-	-	-	-	-

			136 mm	165 mm	190 mm	216 mm	250 mm	260 mm	300 mm	305 mm	315 mm
MAKBLADE PLUS			-	-	✓	-	✓	-	-	-	-
MAKBLADE			-	-	✓	✓	✓	255 mm	260 mm	✓	-
SPECIALIZED ALUMINIO			-	-	✓	✓	-	✓	-	✓	350 mm
SPECIALIZED S. MESA			-	-	-	210 mm	-	✓	-	-	✓
SPECIALIZED S. MESA			-	-	-	-	-	✓	-	-	350 mm
SPECIALIZED LAMINADOS			✓	✓	✓	✓	-	✓	-	✓	-

EFFICUT

Características do tipo de dente EFFICUT



Canto superior agudo



Possibilita um corte fino sem esforço.



Corpo curvo



Permite uma evacuação muito eficiente da aparã.



Base retificada

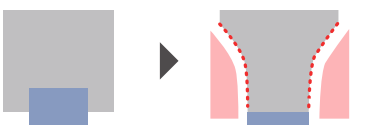

Prolonga a vida útil da bateria, uma vez que é necessário menos esforço para cada corte.

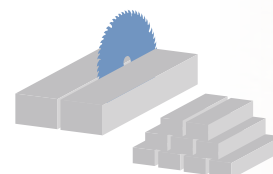

Mais cortes de carga



Cortes rápidos



Duração mais longa da bateria

Lâmina: 1,6 mm

Número de cortes com uma carga



165 mm x 48 T

Lâmina: 1,0 mm



EFFICUT 165 mm x 50 T

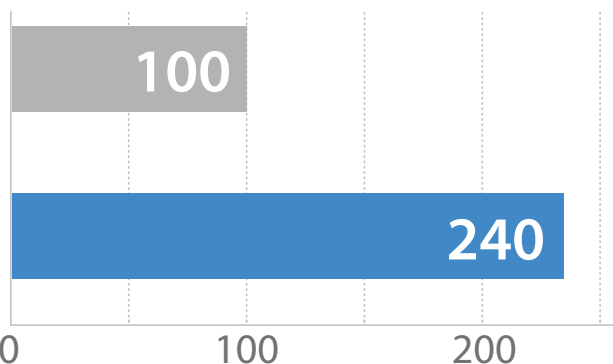

**x 2,4
VEZES MAIS**

- Os resultados dos testes dependem em grande parte da dureza da madeira, etc.
- Os gráficos de barras do número de cortes são valores relativos quando a capacidade (espessura) da lâmina atual: 1,6 mm) é 100.

**CORDLESS
CIRCULAR SAWS**



Discos de serra para serras circulares

Discos Makforce



Uma extensa seleção de lâminas para todas as marcas e modelos de serras circulares portáteis.

Ampla gama de medidas, de 160 mm a 355 mm, e número de dentes de 12 a 60. A gama abrange um grande número de aplicações, desde o corte grosseiro e transversal até ao corte fino e longitudinal.

- A estrutura do disco é feita de aço tensionado de precisão, que absorve impactos sem deformação.
- Carboneto de tungstênio de alta qualidade e baixo desgaste para uma longa vida útil da serra.
- Perfeita nitidez para cortes mais precisos.
- Corte fino, com menos aparas e menos esforço no motor.

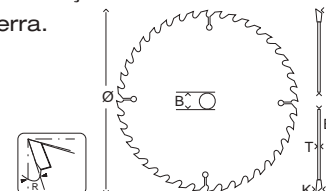

Ø 165 mm DHS660 - DHS661 - DHS680 - DSS610 - HS6100 - HS6601

Ø ext. (mm)	Ø int. (mm)	K (mm)	T (mm)	N.º de dentes	R	Tipo de dente	Redução	Código	EAN	P.V.P (€)
160	20	2,4	1,5	16	20°	ATB	15,88	B-32091	0088381420907	18,45
160	20	2,4	1,5	24	20°	ATB	15,88	B-32203	0088381421010	22,00
160	20	2,4	1,5	40	20°	ATB	15,88	B-32297	0088381421102	27,00
165	20	2,4	1,5	10	20°	FTG	-	B-32100	0088381420914	22,00
170	30	2,4	1,5	16	20°	ATB	15,88	B-32122	0088381420938	21,00
170	30	2,4	1,5	24	20°	ATB	15,88	B-32225	0088381421034	23,00
170	30	2,4	1,5	40	20°	ATB	15,88	B-32312	0088381421126	25,00

Ø 190 mm DHS710 - DHS782 - DHS783 - HS7601 - HS7100 - HS7101 - M5802B - HS004G

180	20	2,4	1,5	16	20°	ATB	-	B-08187	0088381336178	18,55
180	20	2,4	1,5	24	20°	ATB	-	B-08327	0088381336314	23,00
190	30	2	1,4	12	20°	FTG	20/15,88	B-32144	0088381420952	23,00
190	30	2,2	1,4	24	20°	ATB	20/15,88	B-32247	0088381421058	24,00
190	30	2,2	1,4	40	20°	ATB	20/15,88	B-32340	0088381421157	32,00
190	30	2,2	1,4	60	15°	ATAF	20/15,88	B-32390	0088381421201	35,00

Ø 210 mm 5008MG

210	30	2,4	1,6	16	20°	ATB	-	B-32150	0088381420969	23,00
210	30	2,4	1,6	24	20°	ATB	-	B-32253	0088381421065	29,00
210	30	2,4	1,6	40	20°	ATB	-	B-32356	0088381421164	34,00

Ø 235 mm 5903R - 5903RK - DHS900 - HS009G

235	30	2,3	1,6	20	20°	ATB	-	B-32269	0088381421072	24,00
235	30	2,6	1,6	40	20°	ATB	-	B-32362	0088381421171	30,00
235	30	2,8	1,8	60	15°	ATAF	-	B-32415	0088381421225	32,00

Ø 270 mm 5103R - HS0600

270	30	2,6	1,8	24	20°	ATB	-	B-32172	0088381420983	37,00
270	30	2,6	1,6	40	20°	ATB	-	B-32378	0088381421188	43,00
270	30	2,8	1,8	60	15°	ATAF	-	B-32409	0088381421218	47,00

Ø 355 mm 5143R

355	30	3,0	2,2	24	20°	ATB	-	B-32188	0088381420990	52,00
355	30	3,0	2,2	40	20°	ATB	-	B-32281	0088381421096	59,00
355	30	3,0	2,2	60	20°	ATB	-	B-32384	0088381421195	63,00



WOOD

Discos de serra para serras circulares

Discos Specialized Reforçado



Concebidos para serras circulares da Makita e de outros fabricantes de serras, os dentes reforçados ou "dentes embutidos" são especialmente resistentes e de baixo desgaste.

Para cortes fáceis em madeira nodosa. Concebido para evitar que os dentes saltem quando os pregos são acidentalmente cortados na madeira.

Especialmente adequado para trabalhos de recuperação e demolição de madeira.

- Corte em madeira com pregos e nós acidentais.
- Extremamente resistente e de baixo desgaste.
- Aumentam a vida útil da serra e a produtividade.
- Corte fino, com menos aparas e menos esforço no motor.

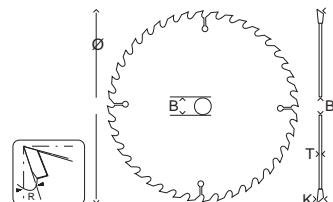

Ø 165 mm DHS660 - DHS661 - DHS680 - DSS610 - HS6100 - HS6601

Ø ext. (mm)	Ø int. (mm)	K (mm)	T (mm)	N.º de dentes	R	Tipo de dente	Redução	Código	EAN	P.V.P (€)
165	20	2	1,25	16	23°	ATB Reforçado	-	B-33037	0088381421904	26,00
165	20	2	1,25	24	23°	ATB Reforçado	-	B-33093	0088381421966	30,00
165	20	2	1,25	40	18°	ATB Reforçado	-	B-33168	0088381422031	34,00

Ø 190 mm DHS710 - DHS782 - DHS783 - HS7601 - HS7100 - HS7101 - M5802B - HS004G

185	30	2	1,25	16	25°	ATB Reforçado	-	B-33043	0088381421911	21,00
185	30	2	1,25	40	25°	ATB Reforçado	-	B-33174	0088381422048	27,00
190	30	2	1,25	16	23°	ATB Reforçado	-	B-33059	0088381421928	21,00
190	30	2	1,25	24	23°	ATB Reforçado	-	B-33118	0088381421980	29,00
190	30	2	1,25	40	23°	ATB Reforçado	-	B-33180	0088381422055	38,00

Ø 210 mm 5008MG

210	30	1,9	1,4	18	23°	ATB Reforçado	-	B-09363	0088381337403	25,00
-----	----	-----	-----	----	-----	---------------	---	---------	---------------	-------

Ø 235 mm 5903R - 5903RK - DHS900 - HS009G

235	30	2,3	1,6	24	23°	ATB Reforçado	-	B-33130	0088381422000	31,00
235	30	2,3	1,6	48	18°	ATB Reforçado	-	B-33196	0088381422062	48,00

Ø 270 mm 5103R - HS0600

270	30	2,6	1,8	24	23°	ATB Reforçado	-	B-33146	0088381422017	60,00
270	30	2,6	1,8	40	18°	ATB Reforçado	-	B-33205	0088381422079	74,00
270	30	2,6	1,8	60	18°	ATB Reforçado	-	B-33211	0088381422086	75,00

Ø 355 mm 5143R

355	30	3	2,2	24	23°	ATB Reforçado	-	B-33087	0088381421959	81,00
355	30	3	2,2	60	18°	ATB Reforçado	-	B-33227	0088381422093	107,00



Discos de serra para serras circulares

Discos MForce



Design avançado e revolucionário para serras circulares.

A face dupla biselada tem um corte fino e o desenho em "M" faz o efeito de dente duplo.

Uma superfície de corte de dentes maior significa uma vida mais longa do que os discos tradicionais. Um corte estreito e um dente estreito reduz o atrito e, assim, reduz o aumento da corrente, protegendo o motor da sua serra. Corte em madeira com pregos e nós acidentais.

- Acabamento perfeito, já que o número de dentes em M é multiplicado por 2.
- Corte agressivo.
- Maior área de trabalho.
- Mais duradouro.

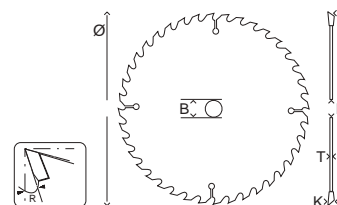

Ø 165 mm DHS660 - DHS661 - DHS680 - DSS610 - HS6100 - HS6601

Ø ext. (mm)	Ø int. (mm)	K (mm)	T (mm)	N.º de dentes	R	Tipo de dente	Redução	Código	EAN	P.V.P (€)
165	20	2	1,2	16	15°	M-Force	-	B-31930	0088381420747	14,70
165	20	2	1,2	24	15°	M-Force	-	B-32007	0088381420815	17,90

Ø 190 mm DHS710 - DHS782 - DHS783 - HS7601 - HS7100 - HS7101 - M5802B - HS004G

185	30	2	1,2	24	15°	M-Force	20/15,88	B-32035	0088381420846	21,00
-----	----	---	-----	----	-----	---------	----------	---------	---------------	-------

Ø 235 mm 5903R - 5903RK - DHS900 - HS009G

235	30	2,3	1,6	40	15°	M-Force	25/15,88	B-32085	0088381420891	32,00
-----	----	-----	-----	----	-----	---------	----------	---------	---------------	-------



Discos Specialized Standard



Concebido para serras circulares Makita e outros fabricantes de serras.

Ø 165 mm DHS660 - DHS661 - DHS680 - DSS610 - HS6100 - HS6601

Ø ext. (mm)	Ø int. (mm)	K (mm)	T (mm)	N.º de dentes	R	Tipo de dente	Redução	Código	EAN	P.V.P (€)
165	20	2,4	1,5	10	20°	ATB	-	D-03327	0088381173667	11,45
165	20	2,0	1,5	16	20°	ATB	-	D-09628	0088381184816	12,60
165	20	2,4	1,5	24	20°	ATB	-	D-03333	0088381173674	13,75
165	20	2,4	1,5	40	18°	ATB	-	D-03349	0088381173681	16,60

Ø 190 mm DHS710 - DHS782 - DHS783 - HS7601 - HS7100 - HS7101 - M5802B - HS004G

185	30	1,8	1,2	16	20°	ATB	20	D-03903	0088381174336	12,60
185	30	2,0	1,2	20	20°	ATB	30/20	D-09634	0088381184823	13,70
185	30	1,8	1,2	40	18°	ATB	20	D-03919	0088381174343	15,45

Ø 210 mm 5008MG

210	30	2,0		24	20°	ATB	-	D-29050	0088381343466	23,00
-----	----	-----	--	----	-----	-----	---	---------	---------------	-------

Ø 235 mm 5903R - 5903RK - DHS900 - HS009G

235	30	2,3	1,6	20	20°	ATB	25	D-03925	0088381174350	19,20
235	30	2,3	1,6	48	18°	ATB	25	D-03931	0088381174367	23,00
235	30	2,3	1,6	60	15°	ATB	25	D-09640	0088381184830	29,00



Discos de serra para serras circulares

Discos Specialized Standard Economy



- Concebido para serras circulares Makita e outros fabricantes de serras.
- Cortes em madeira macia.
- Excelente relação custo-benefício.

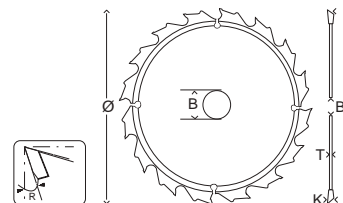

Ø 165 mm DHS660 - DHS661 - DHS680 - DSS610 - HS6100 - HS6601

Ø ext. (mm)	Ø int. (mm)	K (mm)	T (mm)	N.º de dentes	R	Tipo de dente	Redução	Código	EAN	P.V.P (€)
165	20	2,0	1,2	16	12°	ATB	-	D-52554	0088381444422	7,20
165	20	2,0	1,2	24	12°	ATB	-	D-52560	0088381444439	8,45
165	20	2,0	1,2	40	12°	ATB	-	D-52576	0088381444446	10,25

Ø 190 mm DHS710 - DHS782 - DHS783 - HS7601 - HS7100 - HS7101 - M5802B - HS004G

185	30	2,2	1,4	16	18°	ATB	-	D-52582	0088381444453	9,05
185	30	2,2	1,4	24	15°	ATB	-	D-52598	0088381444460	10,25
185	30	2,2	1,4	40	14°	ATB	-	D-52607	0088381444477	11,45

Ø 190 mm DHS710 - DHS782 - DHS783 - HS7601 - HS7100 - HS7101 - M5802B - HS004G

190	30	2,2	1,4	24	15°	ATB	-	D-64951	0088381533096	10,55
190	30	2,2	1,4	40	15°	ATB	-	D-64967	0088381533102	12,05
190	30	2,0	1,4	40	18°	ATB	-	D-64973	0088381533119	14,35

Ø 210 mm - 5008MG

210	30	-	-	24	-	-	-	D-72291	0088381569026	13,05
210	30	-	-	40	-	-	-	D-72300	0088381569033	14,25

Ø 235 mm 5903R - 5903RK - DHS900 - HS009G

235	30	2,5	1,6	20	14°	ATB	-	D-52613	0088381444484	15,65
235	30	2,5	1,6	40	12°	ATB	-	D-52629	0088381444491	18,10
235	30	2,5	1,6	60	12°	ATB	-	D-52635	0088381444507	20,50



Discos de serra para serras circulares

Discos Specialized Alumínio



Ampla gama de lâminas de serra circular com excelente desempenho de corte em alumínio, latão, bronze e outros metais não ferrosos. Os discos também são adequados para trabalhar com plásticos e madeira laminada. Aplique cera de disco na área do dente frequentemente para evitar a acumulação de aparas nos dentes ao cortar metais não ferrosos.

- A estrutura do disco é de aço tensionado de precisão para maior rigidez e cortes mais retos.
- Excelente qualidade de corte em materiais não ferrosos.
- Perfeito desempenho de corte em pisos laminados.

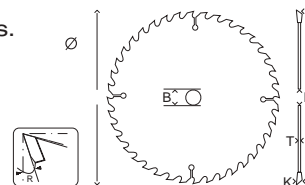

Ø 165 mm DHS680 - DHS660 - DHS661 - DSS610 - HS6601 - HS6100											
Ø ext. (mm)	Ø int. (mm)	K (mm)	T (mm)	N.º de dentes	R	Tipo de dente	Redução	Código	EAN	P.V.P (€)	
160	20	2,4	1,8	60	0°	TCG	-	B-33233	0088381422109	39,00	
Ø 190 mm DHS710 - DHS782 - DHS783 - HS7601 - HS7100 - HS7101 - M5802B - HS004G											
190	30	2,4	1,8	60	0°	TCG	20/15,88	B-33261	0088381422130	55,00	
Ø 210 mm 5008MG											
210	30	2,8	2	54	-5°	TCG	25	B-33548	0088381422437	55,00	
Ø 235 mm 5903R - 5903RK - DHS900 - HS009G											
235	30	2,4	1,8	80	0°	TCG	-	B-33277	0088381422147	63,00	

Discos Specialized Construção



Estes discos são adequados para madeiras de construção, madeiras de cofragem, madeiras com pregos, madeiras prensadas, madeiras com resíduos de betão.

- O dente está embutido no corpo do disco para obter uma grande resistência.
- Os dentes podem ser novamente afiados para um maior aproveitamento do disco.
- Graças à sua estrutura reforçada conseguimos cortes retos sem desvios, sem necessidade de qualquer guia.

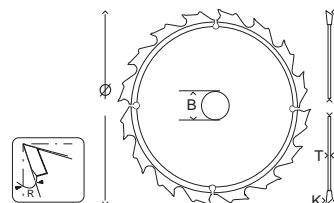

Ø 190 mm DHS710 - DHS782 - DHS783 - HS7601 - HS7100 - HS7101 - M5802B - HS004G											
Ø ext. (mm)	Ø int. (mm)	K (mm)	T (mm)	N.º de dentes	R	Tipo de dente	Redução	Código	EAN	P.V.P (€)	
190	30	2,6	1,6	12	20°	FTG Reforçado	-	B-33554	0088381422444	26,00	
Ø 210 mm 5008MG											
210	30	2,8	1,8	14	20°	FTG Reforçado	-	B-27246	0088381411172	28,00	
Ø 235 mm 5903R - 5903RK - DHS900 - HS009G											
235	30	2,8	1,8	16	20°	FTG Reforçado	-	B-13699	0088381359801	32,00	

Discos de serra para serras circulares

Discos Specialized Painel Sandwich



Lâminas dentadas HM para corte de painel sanduíche específico.

Dente em forma triangular em oposição:

- Reduz a rebarba na peça de trabalho.
- Evita a rutura do disco.
- Ranhuras para evitar vibrações e ruídos.

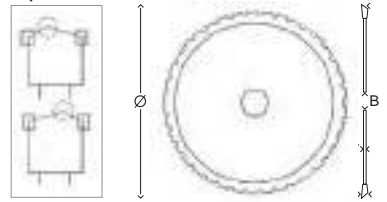

- Ideal para utilizar com os nossos modelos 5903R, 5104S, 5103R e 5143R.
- Longa duração. Muito bom acabamento, graças ao tipo de dente.

Ø 165 mm DHS660 - DHS661 - DSS610 - DHS680 - HS6601 - HS6100

Ø ext. (mm)	Ø int. (mm)	K (mm)	T (mm)	N.º de dentes	R	Tipo de dente	Redução	Código	EAN	P.V.P (€)
165	20	1,75	1,4	42	0°	SMTCG LaserSlit	-	B-63149	-	59,00

Ø 235 mm 5903R - 5903RK - DHS900 - HS009G

235	30	2,2	1,8	50	-	SMTCG LaserSlit	-	B-33582	0088381422475	87,00
-----	----	-----	-----	----	---	-----------------	---	---------	---------------	-------

Ø 270 mm 5103R - HS0600

270	30	2,4	2	60	-	SMTCG LaserSlit	-	B-33598	0088381422482	125,00
-----	----	-----	---	----	---	-----------------	---	---------	---------------	--------

Ø 355 mm 5143R

355	30	2,6	2,2	80	-	SMTCG LaserSlit	-	B-33607	0088381422499	151,00
-----	----	-----	-----	----	---	-----------------	---	---------	---------------	--------



Discos Specialized Bateria



Os discos de qualidade superior são especialmente feitos para serras a bateria.

Lâminas de corte de madeira agora disponíveis para as mais populares serras circulares sem fio.

"Tudo com a qualidade Makita".

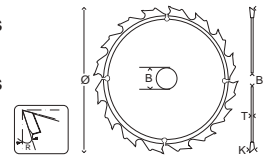

Ø 85 mm HS301D

Ø ext. (mm)	Ø int. (mm)	K (mm)	T (mm)	N.º de dentes	R	Tipo de dente	Redução	Código	EAN	P.V.P (€)
85	15	1,0	0,7	20	10°	ATB	Madeira	B-14607	0088381362689	9,55
85	15	0,5	0,5	50	-	-	Contraplacado	792299-8	0088381101004	13,40
85	15	0,5	0,5	50	-	-	Plástico	792259-0	0088381100816	10,30

Ø 136 mm DSS501

136	20	1,5	1,0	16	20°	ATAF	Madeira	B-10643	0088381347815	24,00
-----	----	-----	-----	----	-----	------	---------	---------	---------------	-------

Ø 165 mm DHS660 - DHS661 - DSS610 - DHS680

165	20	1,6	1	40	18°	ATAF	Madeira	B-32954	0088381421829	25,00
165	20	1,5	1	24	20°	ATAF	Madeira	B-32910	0088381421782	23,00
165	20	1,4	1	25	23	Efficut	Madeira	B-62979	0088381531474	29,00
165	20	1,45	1	56	23°	Efficut	Madeira	B-57336	0088381518420	47,00

Ø 190 mm DHS710 - DHS782 - DHS783 - HS004G

190	30	2	1,4	24	20°	ATAF	Madeira	B-32926	0088381421799	21,00
190	30	2	1,4	40	10°	ATAF	Madeira	B-32976	0088381421843	24,00

Ø 216 mm DHS900

216	30	-	-	45	-	-	-	E-06971	0088381570725	45,00
-----	----	---	---	----	---	---	---	---------	---------------	-------

Ø 235 mm DHS900 - HS009G

235	30	2,2	1,5	24	20	Efficut	Madeira	E-01909	0088381337236	41,00
-----	----	-----	-----	----	----	---------	---------	---------	---------------	-------



Discos de serra para serras circulares

Discos Specialized Incisão



Estes discos são específicos para serras de incisão. Eles são projetados especificamente para conseguir um corte completamente limpo. Os discos para serras de incisão têm uma tecnologia patenteada contra as vibrações. Os discos de baixa vibração realizam o corte com menos vibração, para que o disco entre mais facilmente no material e com menos esforço.

- A estrutura do disco é de aço tensionado de precisão para maior rigidez e cortes mais retos.
- Adequado para cortar madeira.

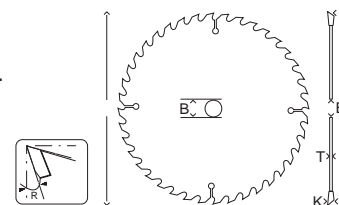

Ø 165 mm DSP600 - DSP601 - SP001G - SP6000

Ø ext. (mm)	Ø int. (mm)	K (mm)	T (mm)	N.º de dentes	R	Tipo de dente	Redução	Código	EAN	P.V.P (€)
160	20	2,2	1,6	28	23°	ATB Laser slit	-	B-32982	0088381421850	29,00
165	20	2	1,4	28	15°	ATB Laser slit	-	B-56699	0088381534765	44,00
160	20	2,2	1,6	48	8°	ATB Laser slit	-	B-32998	0088381421867	35,00
165	20	2,2	1,6	48	8°	ATB Laser slit	-	B-33015	-	53,00

Especial Madeira

165	20	1,85	1,25	48	8°	Corte limpo	-	B-56708	0088381534772	69,00
-----	----	------	------	----	----	-------------	---	---------	---------------	-------

Especial MDF

165	20	2,0	1,4	60	5°	Extralimpo	-	B-56720	0088381534789	57,00
-----	----	-----	-----	----	----	------------	---	---------	---------------	-------

Especial para Corian

165	20	2,4	1,7	48	5°	TCG	-	B-10344	0088381342100	60,00
165	20	2,0	1,4	48	5°	TCG	-	B-56742	0088381534819	66,00

Especial para Alumínio

165	20	2,4	1,7	56	-3°	TCG LaserSlit	-	B-33021	-	57,00
165	20	2,0	1,4	56	-3°	TCG LaserSlit	-	B-56714	0088381534802	68,00



Discos de serra para serras de esquadria

Discos MakBlade corte silencioso



MAKBLADE PLUS

Os discos de serra MAKBLADE PLUS para serras de esquadria têm uma tecnologia única e patenteada. Estes discos são desenvolvidos para atenuar as vibrações e ruídos. Estes discos característicos melhoram o ambiente de trabalho e aumentam a durabilidade da lâmina e a confiabilidade da máquina como um todo. A

vida útil dos dentes é significativamente prolongada por se cuidar melhor dos seus discos de carboneto de tungstênio do que os discos convencionais.

- Menos vibração e ruído.

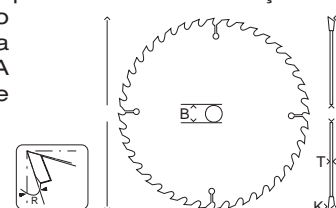

Ø 190 mm DLS600 - DLS714 - LS0714F

Ø ext. (mm)	Ø int. (mm)	K (mm)	T (mm)	N.º de dentes	R	Tipo de dente	Redução	Código	EAN	P.V.P (€)
190	20	2,0	1,4	60	5°	ATAF	-	B-08757	0088381336741	45,00

Ø 250 mm/260 mm DLS111 - LF1000 - LH1040F - LS004G - LS1018L - LS1019L - LS1040F

250	30	2,6	1,8	80	5°	TCG	-	B-42640	0088381440882	92,00
250	30	2,6	1,8	80	5°	HI - ATB	-	B-42662	0088381440905	92,00
250	30	3,2	2,2	80	5°	TCG	-	B-42830	0088381433969	92,00
250	30	3,2	2,2	80	5°	HI - ATB	-	B-42852	0088381433983	92,00

Ø 305 mm DLS211 - LH1201FL - LS003G - LS1219L

300	30	2,6	1,8	96	-5°	HI - ATB	-	B-42678	0088381440912	103,00
300	30	3,2	2,2	96	-5°	HI - ATB	-	B-42868	0088381433990	103,00
305	30	2,5	1,9	70	0°	ATAF	-	B-32568	0088381421379	73,00



Makita

Discos MakBlade



Uma extensa seleção de lâminas para todas as marcas e modelos de serras de esquadria.

Ampla gama de tamanhos de 190 mm a 305 mm e número de dentes de 24 a 100. A gama abrange um grande número de aplicações, desde o corte grosseiro até ao corte extrafino.

- As serras de aço tensionado absorvem os choques sem deformar.
- Carboneto de tungstênio de alta qualidade e baixo desgaste para uma longa vida útil da serra.
- Corte fino com menos aparas e menos stress no motor.

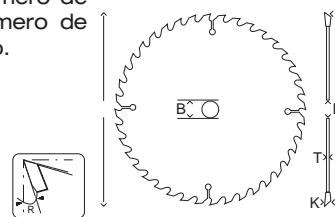

Ø 190 mm DLS600 - LS0714F - DLS714

Ø ext. (mm)	Ø int. (mm)	K (mm)	T (mm)	N.º de dentes	R	Tipo de dente	Redução	Código	EAN	P.V.P (€)
190	20	2,2	1,6	24	5°	ATB	-	B-32708	0088381421515	23,00
190	20	2,2	1,6	48	5°	ATB	-	B-08953	0088381336994	33,00
190	20	2,0	1,4	60	5°	ATB	-	B-09042	0088381337083	33,00

Ø 216 mm LS002G - LS0815FL

216	30	2,1	1,6	40	10°	ATB	-	A-86169	0088381150026	45,00
216	30	2,4	1,6	48	5°	ATB	-	B-32764	0088381421577	41,00
216	30	2,2	1,6	80	5°	ATB	-	A-86468	0088381150804	69,00

Ø 260 mm DLS111 - LF1000 - LH1040F - LS004G - LS1018L - LS1019L - LS1040F

250	30	2,4	1,8	72	5°	ATB	-	B-33308	0088381422185	39,00
250	30	2,3	1,8	100	5°	ATB	-	B-32873	0088381421683	50,00
255	30	2,3	1,8	32	5°	ATB	-	B-32720	0088381421539	52,00
255	30	2,3	1,8	60	5°	ATB	-	B-32792	0088381421607	38,00
260	30	2,3	1,8	40	5°	ATB	-	B-32770	0088381421584	37,00
260	30	2,3	1,8	60	5°	ATB	-	B-32801	0088381421614	45,00
260	30	2,3	1,8	80	5°	ATB	-	B-32845	0088381421652	48,00
260	30	2,3	1,8	100	5°	ATB	-	B-32873	0088381421683	50,00
260	30	2,5	1,65	80	10°	Efficut	-	B-67240	0088381541015	65,00

Ø 305 mm LH1201FL - LS1219L - DLS211

305	30	2,3	1,8	40	5°	ATB	-	B-32786	0088381421591	48,00
305	30	2,3	1,8	60	5°	ATB	-	B-32817	0088381421621	63,00
305	30	2,3	1,8	80	5°	ATB	-	B-32851	0088381421669	75,00
305	30	2,3	1,8	100	5°	ATB	-	B-32889	0088381421690	82,00
305	30	2,5	1,65	80	10°	Efficut	-	B-67256	0088381541022	65,00



Makita

Discos de serra para serras de esquadria

Discos Specialized Alumínio



- Chapas metálicas esticadas de precisão para maior rigidez e cortes mais retos.
- Excelente qualidade de corte em materiais não ferrosos.
- Perfeito desempenho de corte em pisos laminados.

Aplique cera de disco na área do dente frequentemente para evitar a acumulação de aparas nos dentes ao cortar metais não ferrosos.

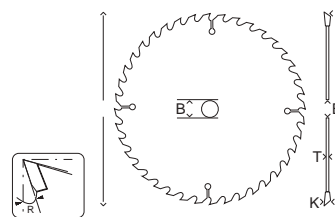

Ø 190 mm DLS600 - DLS714Z - LS0714F

Ø ext. (mm)	Ø int. (mm)	K (mm)	T (mm)	N.º de dentes	R	Tipo de dente	Redução	Código	EAN	P.V.P (€)
190	20	2	1,4	60	-5°	TCG	-	B-33283	0088381422154	41,00

Ø 216 mm LS0815FL - LS002G

216	30	2,2	1,6	64	-5°	TCG	-	B-33299	0088381422178	48,00
-----	----	-----	-----	----	-----	-----	---	---------	---------------	-------

Ø 260 mm DLS111 - LF1000 - LH1040F - LS004G - LS1018L - LS1019L - LS1040F

250	30	2,4	1,8	100	-5°	TCG	-	B-33314	-	68,00
260	30	2,4	1,8	80	-5°	TCG	-	B-33320	0088381422208	63,00
260	30	2,4	1,8	100	-5°	TCG	-	B-33336	0088381422215	70,00
260	30			81		Efficut		E-06317	-	81,00

Ø 305 mm DLS211 - LH1201FL - LS003G - LS1219L

305	30	2,4	1,8	80	-5°	TCG	-	B-33342	0088381422222	66,00
305	30	2,4	1,8	100	-5°	TCG	-	B-33358	-	92,00



Discos Specialized Standard Economy

Ø 305 mm DLS211 - LH1201FL - LS003G - LS1219L

Ø ext. (mm)	Ø int. (mm)	K (mm)	T (mm)	N.º de dentes	R	Tipo de dente	Redução	Código	EAN	P.V.P (€)
305	30	-	-	60	5°	ATB	-	D-72316	0088381569040	33,00
305	30	-	-	80	5°	ATB	-	D-72322	0088381569057	37,00
305	30	-	-	100	5°	ATB	-	D-72338	0088381569064	42,00



Discos Specialized Serras de mesa - Madeira



Concebidos para serras de mesa Makita e outros fabricantes de serras.

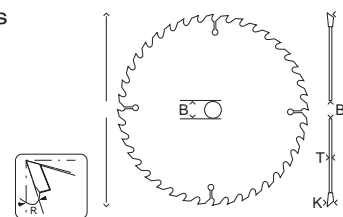

Ø 260 mm 2704 e MLT100

Ø ext. (mm)	Ø int. (mm)	K (mm)	T (mm)	N.º de dentes	R	Tipo de dente	Redução	Código	EAN	P.V.P (€)
260	30	2,3	1,5	40	20°	TCG	-	B-05072	0088381200677	43,00

Ø 315 mm 2712

315	30	2,8	2,0	40	16°	Corte rápido	-	JM27170001	0088381531641	31,00
-----	----	-----	-----	----	-----	--------------	---	------------	---------------	-------

Discos Specialized Serras de mesa - Alumínio



Ø 260 mm 2704 - MLT100

Ø ext. (mm)	Ø int. (mm)	K (mm)	T (mm)	N.º de dentes	R	Tipo de dente	Redução	Código	EAN	P.V.P (€)
260	30	2,8	2,2	80	0°	TCG	-	B-33386	-	71,00

Ø 300 mm

300	30	2,8	2,2	80	0°	TCG	-	B-33392	0088381422277	77,00
-----	----	-----	-----	----	----	-----	---	---------	---------------	-------

Ø 350 mm

350	30	3,2	2,6	100	0°	TCG	25	B-09737	0088381337779	101,00
-----	----	-----	-----	-----	----	-----	----	---------	---------------	--------

Discos Specialized laminados



- Excelente qualidade de corte em pisos laminados.
- Alta precisão de corte em molduras e rodapés.

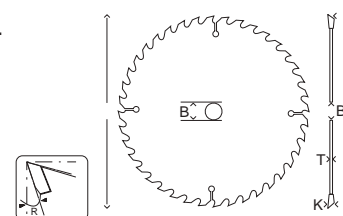

Ø 216 mm LS0815FL - LS002G

Ø ext. (mm)	Ø int. (mm)	K (mm)	T (mm)	N.º de dentes	R	Tipo de dente	Redução	Código	EAN	P.V.P (€)
216	30	2,5	1,8	72	5	TCG	-	B-33853	0088381422703	103,00

Ø 260 mm DLS111 - LF1000 - LH1040F - LS004G - LS1018L - LS1019L - LS1040F

260	30	2,5	1,8	84	5	TCG	-	B-29496	0088381416641	95,00
-----	----	-----	-----	----	---	-----	---	---------	---------------	-------

Ø 305 mm DLS211 - LH1201FL - LS003G - LS1219L

305	30	2,5	1,8	96	5	TCG	-	B-33881	0088381422734	157,00
-----	----	-----	-----	----	---	-----	---	---------	---------------	--------

Discos Specialized Fresagem CA5000

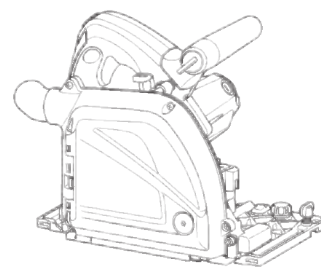

Ø 118 mm - CA5000

Ø ext. (mm)	Ø int. (mm)	K (mm)	T (mm)	N.º dentes	R	Material	Redução	Código	EAN	P.V.P (€)
118	20	14	6	6	90°	Composito de alumínio	-	B-48832	0088381458733	166,00
118	20	18	6	6	135°	Composito de alumínio	-	B-48860	0088381458740	183,00

Lâminas de corte DSC102/SC103D



Tipo	Código	EAN	P.V.P (€)
M6	199087-8	0088381524766	68,00
M8	199085-2	0088381524759	68,00
M10	199083-6	0088381524742	68,00

Disco de corte CP100D



Código	EAN	P.V.P (€)
198603-3	0088381487344	9,40

Disco de corte DSC250



Ø 110 mm - DSC250 - DSC251

Ø ext. (mm)	Ø int. (mm)	K (mm)	T (mm)	N.º dentes	R	Tipo de dente	Redução	Código	EAN	P.V.P (€)
110	15	-	-	24	0°	SMTCG	-	E-11097	0088381581752	67,00



Discos de serra para cortadoras de metal

Discos Specialized - Corte de metal

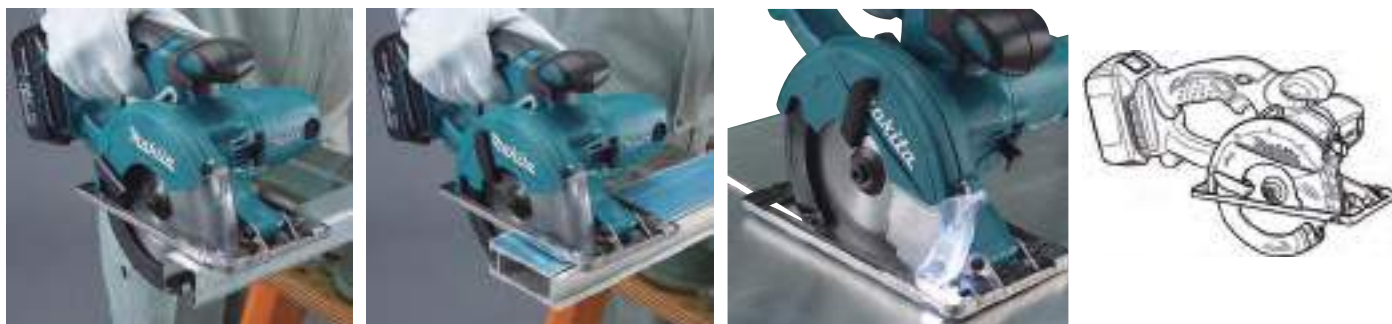

Ø 136 mm DCS550

Ø ext. (mm)	Ø int. (mm)	K (mm)	T (mm)	N.º de dentes	Tipo	Tipo de dente	Redução	Código	EAN	P.V.P (€)
136	20	1,5	1,2	30	-	SMTCG	Metal	B-10615	0088381346689	44,00
136	20	1,4	1,0	50	-	SMTCG	Chapa fina	B-07325	0088381312813	44,00
136	20	1,1	0,95	56	-	SMTCG	Inox	B-23086	0088381406239	73,00

Ø 150 mm DCS551 - DCS553

150	20	1,5	1,2	32	-	SMTCG	Metal	B-47036	-	41,00
150	20	1,4	1,1	52	-	SMTCG	Chapa fina	B-47042	-	57,00
150	20	1,1	0,95	60	-	SMTCG	Inox	B-47058	-	62,00
150	20	1,6	1	52	-	SMTCG	Alumínio	B-47064	-	57,00

Ø 185 mm 4131

Ø ext. (mm)	Ø int. (mm)	K (mm)	T (mm)	N.º de dentes	Tipo	Tipo de dente	Redução	Código	EAN	P.V.P (€)
185	30	1,7	1,3	70	-	HM	Aço	B-33445	-	53,00
185	30	2	1,6	48	-	HM	Aço	B-33451	-	52,00
185	30	2	1,6	38	-	HM	Aço	B-33423	-	47,00
185	30	1,9	1,5	36	-	Cermet	Aço	B-33417	-	65,00

Ø 305 mm LC1230









305	25,4	2,1	1,7	60	-	HM	Aço	B-33439	-	115,00
305	25,4	2,3	2	78	-	HM	Aço macio	B-33467	-	139,00
305	25,4	1,95	1,95	76	-	HM	Inox	A-87579	0088381160445	237,00
305	25,4	2,4	1,5	100	Silencioso	HM	Inox	B-33750	-	283,00



Discos de HM para LC1230



Ø (mm)	N.º de dentes	Código
305	HM60	B-33439
	HM78	B-33467
	HM76	A-87579
	HM100	B-33750

Código	B-33439	B-33467	A-87579	B-33750
Ø (mm)	305 x 25,4			
N.º de dentes	HM60	HM78	HM76	HM100
Material	Aço	Aço macio fino	Inox	Inox
 3 mm	△	⊙	○	○
 4 - 6 mm	⊙	○	○	○
 7 mm -	○	×	○	○
 1,2 - 3 mm	△	⊙	○	○
 3 - 5 mm	⊙	○	○	○
 2 - 4 mm	△	⊙	○	○
 4 mm -	⊙	○	○	○
 Inox 1,2 - 3 mm	×	×	⊙	⊙

Discos de HM para 4131



Ø (mm)	N.º de dentes	Código
185	HM70	B-33445
	HM48	B-33451
	HM38	B-33423
	Cermet 36	B-33417

Código	B-09771	B-33451	B-33423	B-33417
Ø (mm)	185 x 30 x 2	185 x 30 x 2	185 x 30 x 2	185 x 30 x 1,9
N.º de dentes	HM70 (-10°)	HM48 (0°)	HM38 (0°)	*Cermet 36 (0°)
Quadrado de ferro	50 x 50 x 4 mm	×	△	○
	50 x 50 x 4 mm	×	○	△
	50 x 50 x 6 mm	×	○	⊙
	50 x 100 x 3,2 mm	×	○	⊙
Aço em chapas	0,9 x 500 mm	⊙	○	△
	3,0 x 500 mm	△	○	⊙
Perfis em U	50 x 100 x 1,6 mm	×	○	△
	45 x 90 x 3,2 mm	×	○	⊙
Ângulo	50 x 50 x 4 mm	×	△	○
	50 x 50 x 6 mm	×	○	⊙
Tubos de aço temperado	Ø 25 x 1,2 mm	×	⊙	⊙
Tubos metálicos	Ø 60 x 4 mm	×	△	○
Haste	Ø 20 mm	×	△	○
Perfis de paredes divisorias secas	1 mm	⊙	×	×
	1 - 2 mm	×	⊙	△
Chapa ondulada (pégaso)	0,9 mm	⊙	×	×
	1 - 2 mm	△	△	×



- ⊙ Disco ideal.
- Disco adequado.
- △ Disco não recomendado.
- × Disco muito desaconselhado.

Guias de carril e acessórios



Peça para unir dois carris



Guia de carril



Capa para guia de carril

Descrição	Comprimento (m)	Un.	Código	EAN	P.V.P (€)
Peça para unir dois carris	-	1	198885-7	0088381497046	25,00
Guia de carril	1	1	199140-0	0088381528672	45,00
	1,4	1	194368-5	0088381313353	71,00
	1,9	1	194925-9	0088381354790	109,00
	3	1	194367-7	0088381335201	185,00
Capa para guia de carril	1	1	E-05670	0088381567183	46,00
	1,4	1	E-05664	0088381567176	53,00
	1,9	1	E-10920	0088381581523	83,00
	3	1	E-10936	0088381581530	103,00

Suportes de guia de carril

A



192505-5

B

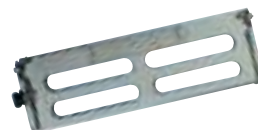

192506-3 e 192507-1

C

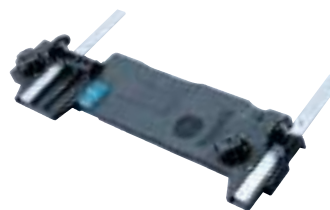

197252-3

D



199232-5



Guia de ângulos



Un.	Código	EAN	P.V.P (€)
1	196664-7	0088381438414	39,00

Modelos	Imagem	Un.	Código	EAN	P.V.P (€)
5603R 5705R	A	1	192505-5	0088381131919	29,00
5903R	B	1	192506-3	0088381132190	114,00
5103R	B	1	192507-1	0088381132206	85,00
HS6100 HS7100 HS7101 DHS710	C	1	197252-3	0088381453790	66,00
HS0600	C	1	198570-2	0088381495912	215,00
HS6601	C	1	197462-2	0088381523837	27,00
HS7601 HS7611	C	1	197005-0	0088381484602	65,00
DHS680	C	1	196953-0	0088381463751	52,00
DHS660	D	1	199232-5	0088381529334	52,00

Peças sobressalentes para guias de carril

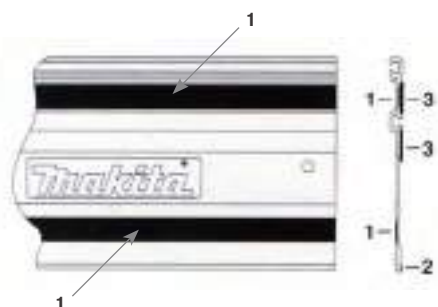

Descrição	Comprimento	Número	Un.	Código	EAN	P.V.P (€)
Borracha deslizante	1,4	1	1	413101-9	3240890284549	4,10
	1,9		1	451330-6	-	6,20
	3,0		1	413102-7	3240890284488	15,45
Borracha anti-lascas	1,4	2	1	423359-2	3240890283870	5,65
	1,9		1	423386-9	-	8,25
	3,0		1	423360-7	3240890284136	11,00
Borracha antideslizante	1,4	3	1	423361-5	3240890282088	6,70
	1,9		1	423390-8	-	9,25
	3,0		1	423362-3	3240890281838	15,45

Grampo para carril de guia



Modelos	Un.	Código	EAN	P.V.P (€)
Guias de carril	2	194385-5	0088381314084	28,00

Guia paralela



Tipo 1

Tipo 2

Modelos	Tipo	Un.	Código	EAN	P.V.P (€)
HS301	1	1	195333-7	-	3,05
5604R 5704R HS5100 HS7100 HS7101 HS7601		1	164095-8	0088381101080	1,80
5017RKB 5603R 5703R 5705R		1	165108-8	0088381141376	6,45
5903R 5103R		1	165084-6	0088381152464	4,20
5143R		1	152498-8	0088381156295	47,00
DSP600 DSP601 SP6000	2	1	165447-6	0088381347587	15,85

Placa-guia para CA5000

- Marca a linha de fresagem.



Modelos	Un.	Código	EAN	P.V.P (€)
CA5000	1	143396-7	-	4,10

Ganchos



199386-8

199231-7



Modelos	Un.	Código	EAN	P.V.P (€)
HS780	1	199386-8	0088381534963	15,65
DHS660	1	199231-7	0088381532839	8,85

Mesa para serras de esquadria



194043-3



DEAWST05



DEAWST06
DEAWST07

Comprimento (mm)	Alto (mm)	Largura (mm)	Modelos	Un.	Código	EAN	P.V.P (€)
762	841	743	LS0714F LH1040F LS1019L LS1018L LS1040F LS1219L LH1201FL	1	198688-9	0088381488938	187,00
2700	500	800	Todos os modelos	1	DEAWST05	0088381424318	326,00
2550	750	850		1	DEBWST06		297,00
3830	860	750	Adequada para todos os modelos, exceto DL5600, LH1040/F e LH1201FL.	1	DEAWST07		407,00

Mesas para serras de mesa



194093-8

JM27000300

Modelos	Un.	Código	EAN	P.V.P (€)
2704	1	194093-8	0088381205702	350,00
MLT100	1	JM27000300	0088381351003	257,00



Extensão de suporte



Modelos	Tipo	Un.	Código	EAN	P.V.P (€)
LH1040 LS1040 LS0714F MLS100	Pé	1	122446-1	0088381156158	27,00
-	Barras	1	256812-1	0088381146517	24,00

Rolo auxiliar



Comprimento (mm)	Altura regulável (mm)	Un.	Código	EAN	P.V.P (€)
250	47 - 140	1	A-47450	0088381289535	102,00

Batente de apoio



Modelos	Un.	Código	EAN	P.V.P (€)
LS1013F/FLB LS1214F/L	1	194002-7	0088381193795	56,00

Batentes para cortes de molduras



Modelos	Un.	Código	EAN	P.V.P (€)
LS003G LS004G LS1019L LS1219L	2	192628-9	0088381141710	40,00
LS1016/L	2	192669-5	0088381146470	71,00

Suportes laterais



Modelos	Un.	Código	EAN	P.V.P (€)
LS0810	1	164806-1	0088381162517	7,70
LS1013F/FLB LS1214F/L	1	322932-4	0088381141673	6,50
LH1040F LS1040F	1	123101-8	0088381538244	14,95
LS1440	2 + Batente ajustável	191239-7	0088381112093	28,00
MLS100	1	JM23000127	0088381347907	9,25
LS1016/L LS1216/FLB	2	195240-4	0088381366250	9,00
LH1200FL	1	JM23100500	0088381373623	10,70
LS1019L LS1219L	1	327095-1	-	5,50

Grampos para serras de esquadria

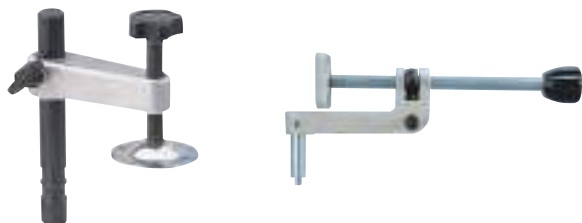

Vertical

Horizontal

Modelos	Tipo	Un.	Código	EAN	P.V.P (€)
LS0714F BLS713RFE	Vertical	1	122571-8	0088381151863	21,90
LS0815		1	JM23510009	0088381447331	10,30
LS1013 LS1214		1	122538-6	0088381141697	18,55
LH1040F LS1040F		1	192625-5	0088381150729	19,00
LS1016/L LS1216/FL		1	122854-6	0088381356619	25,00
LF1000		1	122728-1	0088381288484	16,50
LS1018 LH1200FL		1	JM23100502	0088381373661	6,10
LS1019L LS1219L		1	126617-2	-	28,00
MLS100		1	JM23000131	0088381347938	7,70
LS0714F LS1040 LH1040		Horizontal	1	122567-9	0088381151573
LS1013 LS1214 LS1016/L LS1019L LS1219L	1		122470-4	0088381142625	85,00
LS1216/FLB LH1200FL LS1018L	1		122930-6	0088381366274	74,00

Guias paralelas



Modelos	Un.	Código	EAN	P.V.P (€)
2704	1	122739-6	0088381277020	116,00
LH1040F	1	122707-9	0088381195386	16,10
LF1000	1	122729-9	0088381288460	27,00
LH1201FL	1	JM23300008	3240890401823	52,00
2712	1	JM27110005	-	37,00

Botão de segurança



Modelos	Un.	Código	EAN	P.V.P (€)
Todos os modelos	1	417113-4	-	0,60

Arnês para DLS600



Modelos	Un.	Código	EAN	P.V.P (€)
DLS600	1	166058-0	0088381494953	10,80

Guias de meia-esquadria



Modelos	Un.	Código	EAN	P.V.P (€)
2704N	1	127069-0	-	46,00
LF1000	1	122730-4	0088381288477	15,45

Extensões para 2704

Extensão traseira

Extensão esquerda



Descrição	Un.	Código	EAN	P.V.P (€)
Extensão traseira	1	194087-3	0088381200301	41,00
Extensão esquerda	1	194086-5	0088381200295	34,00

Batentes ajustáveis



Modelos	Un.	Código	EAN	P.V.P (€)
LH1040 LS0714 LS1040	1	122472-0	0088381155892	5,15
MLS100	1	JM23000128	0088381347914	0,75

Lâmpada



Modelos	Un.	Código	EAN	P.V.P (€)
LS0714F LS1013F LS1214F LS1040F	1	193730-1	0088381160353	3,80

Anilha de redução

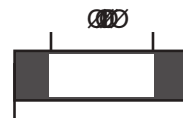

Ø Interior (mm)	Ø Exterior (mm)	Un.	Código	EAN	P.V.P (€)
15,88	25	1	257022-3	0088381189293	0,80
15,88	25,4	1	257060-5	0088381189309	1,30
15,88	30	1	257262-3	-	0,80

Saco e caixa de pó



122852-0



194175-6

Haste de impulso



Un.	Código	EAN	P.V.P (€)
1	416772-1	0088381149426	4,05



Descrição	Modelo	Un.	Código	EAN	P.V.P (€)
Saco	LS1018 LH1201FL	1	JM23100501	0088381373654	3,45
Saco	LS0810	1	122351-2	0088381115537	7,95
Saco	LS0815		JM23510010	0088381447348	6,70
Saco	LS1440	1	122330-0	0088381115544	14,95
Saco	LH1040 LS1214 LS1040 LS1016/L LS11019L LS1219L LS1216/FLB	1	122852-0	0088381356602	3,55
Caixa	Modelos FLB	1	194175-6	0088381349994	37,00

Serras de sabre



Gama de serras de sabre Makita com motor BL sem escovas e tecnologia XPT.



Símbolos



Tipo de dentado

Tipo A

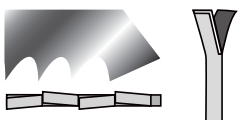

- Dentado: afiação alinhada, cortes rápidos em madeiras duras e macias, alumínio, plásticos e metais não ferrosos.

Tipo B

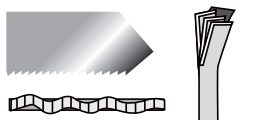

- Dentado: afiação ondulada, corte fino e limpo em madeira, aço macio, alumínio e metais não ferrosos.

Tipo C

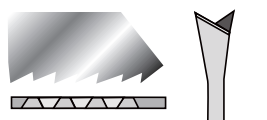

- Dentado: afiação trapezoidal, cortes finos e limpos em madeira e plásticos.

Tipo C

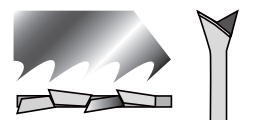

- Dentado: afiação alinhada trapezoidal, cortes grosseiros e rápidos em madeira.

Serras de sabre

Metal



Características	Tipo	Tipo de dentes	Dentes/polegada	Comprimento (mm)	Largura (mm)	Un.	Código	EAN	P.V.P. (€)
Para corte de aço, aço inoxidável e metais não ferrosos entre 3,5 mm e 5 mm. (A cor da lâmina pode variar - azul ou branca).	BiM	B	10	305	0,9	5	B-16857	0088381367554	20,10
				225			P-47008	0088381977432	19,25
				152			P-46997	0088381977425	15,00



Características	Tipo	Tipo de dentes	Dentes/polegada	Comprimento (mm)	Largura (mm)	Un.	Código	EAN	P.V.P. (€)
Para cortar metal de 4 mm a 12 mm. Corte rápido.	BiM	B	8/10	305	0,9	5	B-43212	0088381443081	24,00
				225			B-43181	0088381443050	21,00
				152			B-43147	0088381443012	17,25



Características	Tipo	Tipo de dentes	Dentes/polegada	Comprimento (mm)	Largura (mm)	Un.	Código	EAN	P.V.P. (€)
Dente em M para o corte rápido de aço, aço inoxidável e metais não ferrosos. Cortes em ambos os sentidos para aumentar a velocidade de corte.	BiM	M	M	260	0,9	5	P-45727	0088381976169	25,00
				200			P-45711	0088381976152	20,85
				150			P-45705	0088381976145	17,10



Características	Tipo	Tipo de dentes	Dentes/polegada	Comprimento (mm)	Largura (mm)	Un.	Código	EAN	P.V.P. (€)
Chapa grossa 4-12 mm, tubo <100 mm.	TC	-	8	152	1,25	1	B-55572	0088381483575	17,50
Chapa grossa 4-12 mm, tubo <175 mm.	TC	-	8	228	1,25	1	B-55588	0088381483582	21,00
Chapa grossa 4-12 mm, tubo <250 mm.	TC	-	8	305	1,25	1	B-55594	0088381483599	27,00

Metal



Características	Tipo	Tipo de dentes	Dentes/polegada	Comprimento (mm)	Largura (mm)	Un.	Código	EAN	P.V.P. (€)
Para cortar chapas com menos de 1,2 mm.	BiM	B	32	150	0,9	5	P-04955	0088381914109	15,50



Características	Tipo	Tipo de dentes	Dentes/polegada	Comprimento (mm)	Largura (mm)	Un.	Código	EAN	P.V.P. (€)
Para cortar chapas com mais de 1,2 mm. (A cor da lâmina pode variar - azul ou branca).	BiM	B	24	225	0,9	5	B-43169	0088381443036	17,50
				152			B-16835	0088381367530	11,85
				100			P-04896	0088381914048	13,90



Características	Tipo	Tipo de dentes	Dentes/polegada	Comprimento (mm)	Largura (mm)	Un.	Código	EAN	P.V.P. (€)
Para o corte de aço e aço inoxidável entre 1,5 mm e 2,5 mm. (A cor da lâmina pode variar - azul ou branca).	BiM	B	12	225	0,9	5	B-16776	0088381367479	16,50
				152			B-05169	0088381204224	12,90
				100			P-04874	0088381914024	13,90

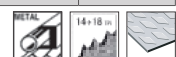

Características	Tipo	Tipo de dentes	Dentes/polegada	Comprimento (mm)	Largura (mm)	Un.	Código	EAN	P.V.P. (€)
Para cortar metal de 3 mm a 8 mm.	BiM	B	14/18	305	1,1	5	B-43206	0088381443074	24,00
				225			B-43175	0088381443043	21,00
				152			B-43131	0088381443005	16,50



Características	Tipo	Tipo de dentes	Dentes/polegada	Comprimento (mm)	Largura (mm)	Un.	Código	EAN	P.V.P. (€)
Para corte de aço e aço inoxidável entre 1,5 mm e 2,5 mm.	BiM	B	18	225	0,9	5	B-16782	0088381367486	16,50
				152			B-16841	0088381367547	11,85



Características	Tipo	Tipo de dentes	Dentes/polegada	Comprimento (mm)	Largura (mm)	Un.	Código	EAN	P.V.P. (€)
Para cortar metal de 2 mm a 10 mm. Corte fino.	BiM	B	10/14	305	1,25	5	B-43228	0088381443098	24,00
				225			B-43197	0088381443067	21,00
				152			B-43153	0088381443029	16,50

Madeira

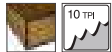

Características	Tipo	Tipo de dentes	Dentes/polegada	Comprimento (mm)	Largura (mm)	Un.	Código	EAN	P.V.P. (€)
Para todos os tipos de madeira com um acabamento fino.	HCS/CV	A	10	152	1,05	5	B-16807	0088381367509	9,00

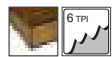

Características	Tipo	Tipo de dentes	Dentes/polegada	Comprimento (mm)	Largura (mm)	Un.	Código	EAN	P.V.P. (€)
Lâmina grossa para cortes rápidos em madeira, plásticos e placas de gesso cartonado.	HCS/CV	A	6	305	1,25	5	B-16829	0088381367523	14,95



Características	Tipo	Tipo de dentes	Dentes/polegada	Comprimento (mm)	Largura (mm)	Un.	Código	EAN	P.V.P. (€)
Lâmina grossa para cortes rápidos em madeira, plásticos e placas de gesso cartonado.	HCS/CV	A	6	225	1,27	5	P-47092	0088381977524	13,90



Características	Tipo	Tipo de dentes	Dentes/polegada	Comprimento (mm)	Largura (mm)	Un.	Código	EAN	P.V.P. (€)
Lâmina grossa para cortes rápidos em madeira, plásticos e placas de gesso cartonado.	HCS/CV	C	6	150	1,27	5	P-47086	0088381977517	12,85



Características	Tipo	Tipo de dentes	Dentes/polegada	Comprimento (mm)	Largura (mm)	Un.	Código	EAN	P.V.P. (€)
Lâmina grossa para cortes rápidos em madeira, plásticos e placas de gesso cartonado.	BiM	A	6	150	1,27	5	P-05088	0088381914314	20,35

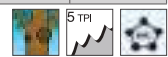

Características	Tipo	Tipo de dentes	Dentes/polegada	Comprimento (mm)	Largura (mm)	Un.	Código	EAN	P.V.P. (€)
Lâmina especial para madeira verde	HCS/CV	C	5	305	1,5	5	B-16863	0088381367561	19,05



Características	Tipo	Tipo de dentes	Dentes/polegada	Comprimento (mm)	Largura (mm)	Un.	Código	EAN	P.V.P. (€)
Lâmina especial para madeira verde	HCS/CV	C	4 - 5	240	1,27	5	P-47117	0088381977548	15,50



Características	Tipo	Tipo de dentes	Dentes/polegada	Comprimento (mm)	Largura (mm)	Un.	Código	EAN	P.V.P. (€)
Para cortes curvos em madeira e plástico.	HCS/CV	C	6	152	1,27	5	B-16798	0088381367493	9,00

Madeira



Características	Tipo	Tipo de dentes	Dentes/polegada	Comprimento (mm)	Largura (mm)	Un.	Código	EAN	P.V.P. (€)
Para cortes curvos e limpos em madeira, plástico e plexiglas.	HCS/CV	D	6	150	1,8	5	P-47101	0088381977531	19,25



Características	Tipo	Tipo de dentes	Dentes/polegada	Comprimento (mm)	Largura (mm)	Un.	Código	EAN	P.V.P. (€)
Lâmina grossa para cortes rápidos em madeira, plásticos e placas de gesso cartonado.	HCS/CV	A	3	152	1,25	5	B-16813	0088381367516	9,00



Características	Tipo	Tipo de dentes	Dentes/polegada	Comprimento (mm)	Largura (mm)	Un.	Código	EAN	P.V.P. (€)
Dentado muito grosso para cortes rápidos e agressivos em madeiras húmidas.	HCS/CV	C	3	240	1,27	5	P-47123	0088381977555	16,60



Características	Tipo	Tipo de dentes	Dentes/polegada	Comprimento (mm)	Largura (mm)	Un.	Código	EAN	P.V.P. (€)
Dentado muito grosso para cortes rápidos e agressivos em madeiras húmidas.	HCS	D	8,5	250	1,0	1	B-62016	0088381528719	15,45

S-EXPRESS



Características	Tipo	Tipo de dentes	Dentes/polegada	Comprimento (mm)	Largura (mm)	Un.	Código	EAN	P.V.P. (€)
Lâmina superexpresso com alto desempenho em serras sobre a bateria: Metal.	BiM	-	7 - 18	152	-	5	B-05038	0088381200592	16,50

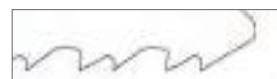

Características	Tipo	Tipo de dentes	Dentes/polegada	Comprimento (mm)	Largura (mm)	Un.	Código	EAN	P.V.P. (€)
Lâmina superexpresso com alto desempenho em serras sobre a bateria: Universal.	BiM	-	6 - 11	152	-	5	B-05044	0088381200608	14,40



Características	Tipo	Tipo de dentes	Dentes/polegada	Comprimento (mm)	Largura (mm)	Un.	Código	EAN	P.V.P. (€)
Lâmina superexpresso com alto desempenho em serras sobre a bateria: Madeira.	BiM	-	6 - 10	203	-	5	B-05153	0088381200943	14,95

Madeira + Metal

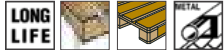

Características	Tipo	Tipo de dentes	Dentes/polegada	Comprimento (mm)	Largura (mm)	Un.	Código	EAN	P.V.P. (€)
Especial para Paletes	BIM	B	10	180	0,9	200	B-54265	0088381477307	385,00

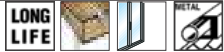

Características	Tipo	Tipo de dentes	Dentes/polegada	Comprimento (mm)	Largura (mm)	Un.	Código	EAN	P.V.P. (€)
Especialmente concebido para a reparação de paletes. Para cortar madeira com resíduos metálicos. Lâmina grossa.	BIM	A	8/10	150	1,27	5	P-47064	0088381977494	18,55



Características	Tipo	Tipo de dentes	Dentes/polegada	Comprimento (mm)	Largura (mm)	Un.	Código	EAN	P.V.P. (€)
Madeira com pregos, pvc, demolição.	BiM	-	5/8	305	1,6	5	B-43278	0088381443142	30,00
	BiM	-	5/8	225	1,6	5	B-43256	0088381443128	26,00
	BiM	-	5/8	152	1,6	5	B-43234	0088381443104	21,00



Características	Tipo	Tipo de dentes	Dentes/polegada	Comprimento (mm)	Largura (mm)	Un.	Código	EAN	P.V.P. (€)
Dente em M para o corte rápido de madeira e madeira com pregos. Cortes em ambos os sentidos para aumentar a velocidade de corte.	BiM	A	6	152	1,25	5	B-05175	0088381204231	14,95



Características	Tipo	Tipo de dentes	Dentes/polegada	Comprimento (mm)	Largura (mm)	Un.	Código	EAN	P.V.P. (€)
Dente em M para o corte rápido de madeira e madeira com pregos. Cortes em ambos os sentidos para aumentar a velocidade de corte.	BiM	M	-	200	0,9	5	P-45696	0088381976138	20,85
	BiM	M	-	150	0,9	5	P-45680	0088381976121	17,10



Madeira + Metal



Características	Tipo	Tipo de dentes	Dentes/polegada	Comprimento (mm)	Largura (mm)	Un.	Código	EAN	P.V.P. (€)
Especialmente concebido para a reparação de paletes. Para cortar madeira com resíduos metálicos. Lâmina grossa.	BiM	A	10/14	225	1,27	5	P-47195	0088381977623	19,80
	BiM	A	10/14	150	1,27	5	P-47189	0088381977616	15,00

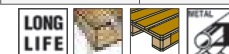

Características	Tipo	Tipo de dentes	Dentes/polegada	Comprimento (mm)	Largura (mm)	Un.	Código	EAN	P.V.P. (€)
Especialmente concebido para a reparação de paletes. Para cortar madeira com resíduos metálicos. Lâmina fina.	BiM	A	10/14	280	0,9	5	P-67767	0088381998291	24,00
	BiM	A	10/14	152	0,9	5	P-47014	0088381977449	14,40



Características	Tipo	Tipo de dentes	Dentes/polegada	Comprimento (mm)	Largura (mm)	Un.	Código	EAN	P.V.P. (€)
Especial para paletes. Madeira com pregos, PVC e alumínio.	BiM	B	10/14	225	0,9	5	B-43262	0088381443135	17,50
	BiM	B	10/14	152	0,9	5	B-43240	0088381443111	12,90



Características	Tipo	Tipo de dentes	Dentes/polegada	Comprimento (mm)	Largura (mm)	Un.	Código	EAN	P.V.P. (€)
Especialmente para paletes, madeira com pregos, alumínio.	BiM	B	10	225	0,9	5	B-31859	0088381420129	17,50
	BiM	B	10	152	0,9	5	B-31843	0088381420112	12,90



ESPECIAIS



Características	Tipo	Tipo de dentes	Dentes/polegada	Comprimento (mm)	Largura (mm)	Un.	Código	EAN	P.V.P. (€)
Serra sabre de resgate 152 x 1,25 mm 6-8 TPI. Recomendada para situações de resgate.	TC/HM	-	6-8	152	1,25	25	B-67206	0088381540759	271,00

ESPECIAIS



Características	Tipo	Tipo de dentes	Dentes/polegada	Comprimento (mm)	Largura (mm)	Un.	Código	EAN	P.V.P. (€)
Ideal para madeiras duras, betão esponjoso, eternit, plásticos reforçados com fibra de vidro e epóxi. Dentes de carboneto de tungsténio	HM	A	3	400	1,3	1	P-05066	0088381914215	46,00
	HM	A	6	300	1,3	-	P-05050	0088381914208	51,00
				150			P-05044	0088381914192	24,00
				100			P-05038	0088381914185	20,85



Características	Tipo	Tipo de dentes	Dentes/polegada	Comprimento (mm)	Largura (mm)	Un.	Código	EAN	P.V.P. (€)
Especial para tijolos.	HM	-	2	400	-	1	B-10403	0088381342667	47,00
				265			B-10394	0088381342650	34,00



Características	Tipo	Tipo de dentes	Dentes/polegada	Comprimento (mm)	Largura (mm)	Un.	Código	EAN	P.V.P. (€)
Especial para tijolos ocós.	HM - TC	-	2	240	-	1	B-12809	0088381355544	26,00

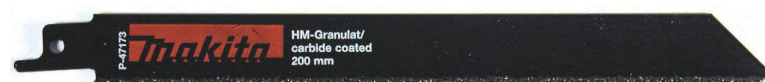

Características	Tipo	Tipo de dentes	Dentes/polegada	Comprimento (mm)	Largura (mm)	Un.	Código	EAN	P.V.P. (€)
Para corte em cerâmica, ferro fundido, tijolo muito duro e plásticos reforçados com fibra de vidro e epóxi.	CV-HM	-	-	180	1,05	2	P-47173	0088381977609	16,05



Características	Tipo	Tipo de dentes	Dentes/polegada	a Comprimento (mm)	Largura (mm)	Un.	Código	EAN	P.V.P. (€)
Especialmente para produtos congelados. Lâmina de aço inoxidável não pintada.	INOX	-	6	152	-	1	B-52043	0088381467544	22,00
		A		250			B-10609	0088381346641	9,55
		-		228			B-30564	0088381418607	22,00

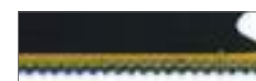

Características	Tipo	Tipo de dentes	Dentes/polegada	Comprimento (mm)	Largura (mm)	Un.	Código	EAN	P.V.P. (€)
Especialmente concebido para o corte de aço inoxidável.	HN	-	18	152	-	2	B-07250	0088381310734	30,00



Características	Tipo	Tipo de dentes	Dentes/polegada	Comprimento (mm)	Largura (mm)	Un.	Código	EAN	P.V.P. (€)
Fibrocimento/Tijolo 10-250 mm Epóxi 6-150 mm	TC/HM	-	3	305	1,5	2	B-63585	0088381532846	40,00



Características	Tipo	Tipo de dentes	Dentes/polegada	Comprimento (mm)	Largura (mm)	Un.	Código	EAN	P.V.P. (€)
Fibrocimento/Tijolo 20-350 mm Epóxi 6-150 mm	TC/HM	-	2	400	1,5	2	B-63591	0088381532853	48,00

Para serra de sabre JR100D - DJR183



Características	Tipo	Tipo de dentes	Dentes/polegada	Comprimento (mm)	Largura (mm)	Un.	Código	EAN	P.V.P. (€)
Metal	BiM	-	24	100	0,7 - 3,0	5	B-20395	0088381375986	11,35



Características	Tipo	Tipo de dentes	Dentes/polegada	Comprimento (mm)	Largura (mm)	Un.	Código	EAN	P.V.P. (€)
Metal	BiM	-	18	100	1,5 - 4,0	5	B-20404	0088381375993	11,35



Características	Tipo	Tipo de dentes	Dentes/polegada	Comprimento (mm)	Largura (mm)	Un.	Código	EAN	P.V.P. (€)
Metal	BiM	-	14	100	3,0 - 8,0	5	B-20410	0088381376006	11,35



Características	Tipo	Tipo de dentes	Dentes por polegada	Comprimento (mm)	Largura (mm)	Un.	Código	EAN	P.V.P. (€)
Madeira - metal	BiM	-	10	100	Metal 3,0 - 12/ Madeira 10 - 50	5	B-20426	0088381376013	11,35



Características	Tipo	Tipo de dentes	Dentes/polegada	Comprimento (mm)	Largura (mm)	Un.	Código	EAN	P.V.P. (€)
Madeira com pregos	BiM	-	6	100	10 - 50	5	B-20432	0088381376020	11,35



Características	Tipo	Tipo de dentes	Dentes/polegada	Comprimento (mm)	Largura (mm)	Un.	Código	EAN	P.V.P. (€)
Painéis de fibra	BiM	-	6	100	5,0 - 50	5	B-20448	0088381376037	11,35



Características	Tipo	Tipo de dentes	Dentes/polegada	Comprimento (mm)	Largura (mm)	Un.	Código	EAN	P.V.P. (€)
Madeira - metal	BiM	-	14/18	100	Metal 3,0 - 8,0/ Madeira 10 - 50	5	B-20454	0088381376044	11,35



Lâminas para 2107FK/2107FXK (13 mm x 0,5 mm x 1140 mm)

Corte de METAL



P. no F./Metal	A.B. /Gusa	Velocidade		Espessura (mm)	Material	Dentes por polegada	Un.	Código	EAN	P.V.P. (€)
		Alta	Baixa							
1	2	1	2	0,5	Aço ao carbono	14	3	792560-3	0088381117517	37,00
1	2	1	2	0,5		18	3	792559-8	0088381117524	37,00
1	2	1	2	0,5		24	3	792558-0	0088381117531	37,00
1	2	1	2	0,5	Bimetal	14HSS	1	194691-8	0088381350808	21,00
1	2	1	2	0,5		18HSS	1	792556-4	0088381117555	23,00
1	2	1	2	0,5		24HSS	1	194692-6	0088381350815	21,00

Corte de MADEIRA

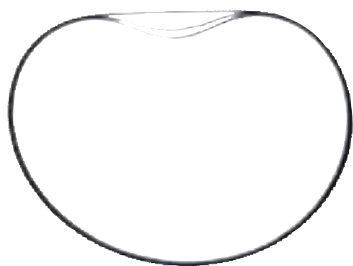

Madeira		Velocidade		Espessura (mm)	Material	Dentes por polegada	Un.	Código	EAN	P.V.P. (€)
Com pregos	Sem pregos	Alta	Baixa							
1	1	1	-	0,5	Aço ao carbono	6	3	792567-9	0088381117579	37,00

Serras de fita para LB1200F (2240 mm)



Aplicação	Material	Espessura (mm)	Dentes por polegada	Largura da lâmina (mm)	Un.	Código	EAN	P.V.P. (€)
Madeira corte transversal	Aço ao carbono	0,5	4	16	3	B-16667	0088381366731	56,00
Madeira corte universal		0,5	4	13	3	B-16673	0088381366748	47,00
Madeira corte curvo		0,5	6	6	3	B-16689	0088381366755	46,00
Metais não ferrosos		0,5	14	16	3	B-16695	0088381366762	62,00

Serras de fita para DPB181 - DPB182 - DPB183 (835 mm)



Aplicação	Material	Espessura	Dentes por polegada	Largura da lâmina (mm)	Un.	Código	EAN	P.V.P. (€)
Plásticos, metais não ferrosos, ferro, aço inoxidável	Bimetal	0,5	14	13	5	B-40543	0088381438377	48,00
		0,5	18	13	5	B-40559	0088381438384	48,00
		0,5	24	13	5	B-40565	0088381438391	47,00

Serras para DSD180 - SD100D



Aplicação	Un.	Código	EAN	P.V.P. (€)
Paredes divisórias secas*	2	B-49703	0088381460934	21,00
Madeira	2	B-49719	0088381460941	27,00

* Perfeita para realizar recortes em paredes divisórias secas.





Suporte de lixas LB1200F



Un.	Código	EAN	P.V.P. (€)
1	JM21000330	0088381374170	14,95

Guia paralela para LB1200F



Un.	Código	EAN	P.V.P. (€)
1	JM21080230	3240890352613	19,55

Guia angular



Un.	Código	EAN	P.V.P. (€)
1	JM21080260	3240890352620	10,80

Extensão de mesa para LB1200F



Un.	Código	EAN	P.V.P. (€)
1	JM21000300	0088381374156	83,00

Jogo para corte circular para LB1200F

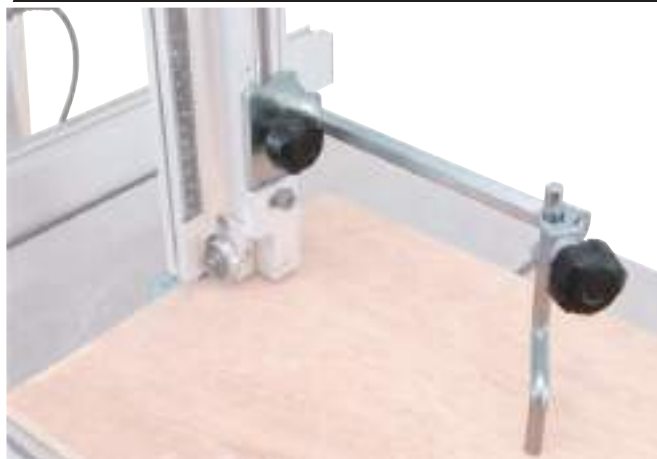

Un.	Código	EAN	P.V.P. (€)
1	JM21000320	0088381374163	23,00

Conexão de aspiração



Un.	Código	EAN	P.V.P. (€)
1	JM27000090	3240890357519	0,75

Suporte e protetor para 2107FK



Protetor



Suporte



Descrição	Un.	Código	EAN	P.V.P. (€)
Protetor	1	196325-9	0088381431576	108,00
Suporte	1	194026-3	0088381194662	640,00



Batente de profundidade

Pasta lubrificante



Fixo

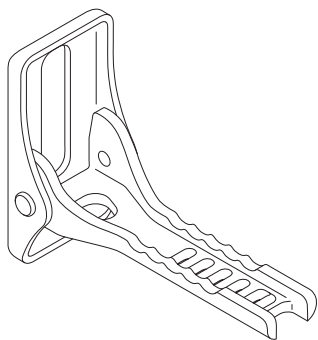

Móvel



Modelo	Tipo	Un.	Código	EAN	P.V.P. (€)
JR3050T JR3060T	Fixo (equipamento básico)	1	165396-7	-	5,50
JR3070CT	Fixo (equipamento básico)	1	165406-0	-	4,80
JR3070CT	Móvel (opcional)	1	163453-5	-	7,10

Un.	Código	EAN	P.V.P. (€)
1	191897-9	0088381117319	11,35

Serras tico-tico



Serra tico-tico de 18 V com motor BL sem escovas.



DJV182 e DJV181

**BL
MOTOR**



**Velocidade variável.
Coletor de pó com a
possibilidade de ligação à
nossa gama de aspiradores.**









Sistema pendular em 4 posições, para cortes rápidos.















Explicação de símbolos e materiais

Materiais

	Madeira		Corte imperfeito
	Madeira com pregos		Corte perfeito
	Aglomerado		Alumínio
	Parquet laminado		Aço inoxidável
	Plástico reforçado com fibra de vidro		Chapas de sanduíche
	PVC (plástico)		Vidro, cerâmica
	Metal		Borracha, couro, material isolante

Tipo de lâmina

		Qualidade do material da serra		Longa duração
				Lâmina extremamente afiada
	Corte reto		CORTE RÁPIDO	Corte rápido
	Corte curvo		Lâmina dupla	
	Dentado com os dentes inclinados		Combinado	



Corte Super Express



Tipo	Descrição	Dentes por polegada	Comprimento útil (mm)	Qualidades do material	Madeira	Plástico	Alumínio	metal inox	Metal não ferroso	metal	Tipo Classe B	Un. embalagem	Código	EAN	P.V.P (€)
B-50	Lâmina super express com alto desempenho nas serras tico-tico a bateria: madeira e plástico.	8 - 11	73	HCS	5,5	5,5	-	-	-	-	T234X	5	B-06460	0088381276702	8,00

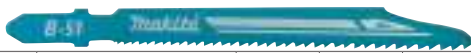

B-51	Lâmina super express com alto desempenho nas serras tico-tico a bateria: metal	10 - 18	73	HHS	-	-	-	1,3	-	1,8	T123X	5	B-06476	0088381276719	8,00
------	--	---------	----	-----	---	---	---	-----	---	-----	-------	---	---------	---------------	------



B-52	Lâmina super express com alto desempenho nas serras tico-tico a bateria: universal	6 - 10	73	HHS	5,5	5,5	-	-	-	-	T345XF	5	B-06482	0088381276726	9,55
------	--	--------	----	-----	-----	-----	---	---	---	---	--------	---	---------	---------------	------



-	Conjunto Super Express	-	77	HHS	-	-	-	-	-	-	-	3	B-06292	0088381249713	6,20
---	------------------------	---	----	-----	---	---	---	---	---	---	---	---	---------	---------------	------

Corte básico - Madeira



Tipo	Descrição	Dentes por polegada	Comprimento útil (mm)	Qualidades do material	Madeira	Plástico	Alumínio	metal inox	Metal não ferroso	metal	Tipo Classe B	Un. embalagem	Código	EAN	P.V.P (€)
B13	Para cortes em madeira e plástico	8	75	HCS	4-65	4-65	-	-	-	-	T111C	5	A-85656	0088381149563	4,20



B15	Para madeira prensada e painéis de fibra de até 3 mm, plásticos até 35 mm.	12	50	HCS	3-35	3-35	-	-	-	-	T119B	5	A-85678	0088381149655	3,90
-----	--	----	----	-----	------	------	---	---	---	---	-------	---	---------	---------------	------



B14	Para madeira prensada e painéis de fibra de até 8 mm, plásticos até 35 mm (corte rápido).	18	51	HCS	2-35	2-35	-	-	-	-	-	5	A-85662	0088381149648	3,90
-----	---	----	----	-----	------	------	---	---	---	---	---	---	---------	---------------	------



B18	Ideal para cortes curvos em madeira e plástico	14	44	HCS	2-35	2-35	-	-	-	-	T119BO	5	A-85709	0088381149662	4,45
-----	--	----	----	-----	------	------	---	---	---	---	--------	---	---------	---------------	------

Corte rápido - Madeira



Tipo	Descrição	Dentes por polegada	Comprimento útil (mm)	Qualidades do material	Madeira	Plástico	Alumínio	metal inox	Metal não ferroso	metal	Tipo Classe B	Un. embalagem	Código	EAN	P.V.P (€)
B16	Para corte rápido em madeira e plástico. Corte rápido e grosseiro.	6	75	HCS	5-65	5-65	-	-	-	-	T144D	5	A-85684	0088381149686	5,65
L02	Ideal para cortes rápidos em materiais grossos	6	100	HCS	5-90	5-90	-	-	-	-	-	5	A-86309	0088381150279	8,05
L10	Para todos os tipos de corte em madeira. Corte rápido e grosseiro.	6	151	HCS	5-135	5-135	-	-	-	-	T344D	5	A-86315	0088381150286	11,00
B17	Ideal para cortes curvos em madeira e plástico (corte rápido).	6	70	HCS	5-60	-	-	-	-	-	T244D	5	A-85690	0088381149693	5,80
-	Corte curvo e rápido para todos os tipos de madeira.	6	75	HCS/CV	8-65	-	-	-	-	-	-	5	P-31572	0088381959735	7,75
-	Corte rápido em todos os tipos de madeira com uma vida útil prolongada.	6	75	BIM	8-65	-	-	-	-	-	T144DF	5	P-31588	0088381959742	10,15

Corte em madeiras laminadas



Tipo	Descrição	Dentes por polegada	Comprimento útil (mm)	Qualidades do material	Madeira	Plástico	Alumínio	metal inox	Metal não ferroso	metal	Tipo Classe B	Un. embalagem	Código	EAN	P.V.P (€)
B19	Para madeira laminada e folheado decorativo de acabamento. Dentes invertidos.	12	63	HCS	3-50	3-50	-	-	-	-	T101BR	5	A-85715	0088381149709	5,50
B28	Para madeira laminada e folheado decorativo de acabamento.	16	63	HSS	2-50	2-50	-	-	-	-	T101BIF	5	A-80391	0088381136938	10,50
B-53	Para corte reto em laminados, pavimentos de madeira e madeiras decorativas. Sem lascas.	15	82	-	-	-	-	-	-	-	T101BIF	5	B-10970	0088381351461	12,35
B-54	Para corte curvo em laminados, pavimentos de madeira e madeiras decorativas. Sem lascas.	15	82	-	-	-	-	-	-	-	T101AOF	5	B-10986	0088381351478	14,40
B16	Lâmina especial para cortes superficiais sem lascas, em soalhos laminados e parquet	12	60	BIM	5-20	-	-	-	-	-	T101AIF	5	P-31566	0088381959728	10,45

Corte limpo em madeira

Tipo	Descrição	Dentes por polegada	Comprimento útil (mm)	Qualidades do material	Madeira	Plástico	Alumínio	metal inox	Metal não ferroso	metal	Tipo Classe B	Un. embalagem	Código	EAN	P.V.P (€)
N59	Corte rápido e limpo em todo o tipo de madeira e plástico...	8	75	HCS	4-65	4-65	-	-	-	-	T101B	5	A-86583	0088381150934	7,30
B10	Corte rápido e limpo em madeira e plástico, especialmente adequado para contraplacado.	9	75	HCS	3-65	3-65	-	-	-	-	-	5	A-85628	0088381149716	6,20
B11	Para uma rápida conclusão do trabalho. Corte limpo.	9	75	HCS	3-60	3-60	-	-	-	-	T101B	5	A-85634	0088381149549	6,50
B12	Para uma rápida conclusão do trabalho. Corte limpo.	6	75	HCS	5-65	5-65	-	-	-	-	T101D	5	A-85640	0088381149556	5,20
L01	Lâmina grossa e comprida para cortes limpos e retos.	6	100	HCS	5-90	5-90	-	-	-	-	T301CD	5	A-86290	0088381150262	11,55
B29	Ideal para o corte curvo em madeira e plástico. (acabamento).	16	42	HCS	2-35	2-35	-	-	-	-	T101AO	5	A-80400	0088381136945	9,95
BR13	Corte sem lascas em madeira, sem necessidade de lixamento. A lâmina corta para cima e para baixo para um bom acabamento superficial.	9	64	HCS	5-65	-	-	-	-	-	-	5	A-85793	0088381149679	4,45
-	Corte limpo em todos os tipos de madeira e plástico com uma vida útil prolongada.	10	75	BIM	5-65	5-65	-	-	-	-	T101BF	5	P-31594	00883811959759	10,70

Corte - Madeiras duras

Tipo	Descrição	Dentes por polegada	Comprimento útil (mm)	Qualidades do material	Madeira	Plástico	Alumínio	metal inox	Metal não ferroso	metal	Tipo Classe B	Un. embalagem	Código	EAN	P.V.P (€)
B25	Para madeira dura, para folheado.	9	75	HSS	3-60	3-60	3-6	-	-	3-6	T127D	5	A-85765	0088381149600	5,25
B26	Para cortes curvos em madeira dura, metal, metal não ferroso e plásticos duros.	9	70	HSS	3-60	3-60	3-10	-	3-10	3-10	T227D	5	A-85771	0088381149617	5,85

Corte - Madeira com pregos



Tipo	Descrição	Dentes por polegada	Comprimento útil (mm)	Qualidades do material	Madeira	Plástico	Alumínio	metal inox	Metal não ferroso	metal	Tipo Classe B	Un. embalagem	Código	EAN	P.V.P (€)
M-Force	Dente em M para o corte rápido de madeira, metais e madeira com pregos. Cortes em ambos os sentidos para aumentar a velocidade de corte.	5	130	BIM	105	-	-	-	-	-	-	2	P-45749	0088381976183	8,05



-	Ideal para madeira com pregos.	9-10	105	BIM	5-95	-	-	-	-	2,5-10	-	5	P-49638	0088381980081	11,75
---	--------------------------------	------	-----	-----	------	---	---	---	---	--------	---	---	---------	---------------	-------



-	Ideal para madeira com pregos.	9-10	75	BIM	5-65	-	-	-	-	2,5-10	T111HF	5	P-49622	0088381980074	10,45
---	--------------------------------	------	----	-----	------	---	---	---	---	--------	--------	---	---------	---------------	-------

Corte básico - Metal



Tipo	Descrição	Dentes por polegada	Comprimento útil (mm)	Qualidades do material	Madeira	Plástico	Alumínio	metal inox	Metal não ferroso	metal	Tipo Classe B	Un. embalagem	Código	EAN	P.V.P (€)
N51	Para chapas finas de aço e aço inoxidável.	24	75	HSS	-	1,5-6	1,5-6	1-3	-	1-3	-	5	A-86561	0088381150910	6,90

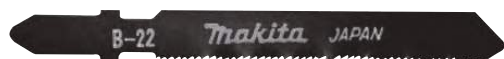

B22	Para aço médio, inoxidável e plásticos duros, especialmente adequada para chapas finas.	24	50	HSS	-	1-6	1-3	1-3	-	1-3	T118A	5	A-85737	0088381149570	5,25
-----	---	----	----	-----	---	-----	-----	-----	---	-----	-------	---	---------	---------------	------



B24	Para aço médio fino, inoxidável e chapas de aço muito finas.	32	50	HSS	-	1-3	1-2	0,5-2	-	0,5-2	T118G	5	A-85759	0088381149594	5,00
-----	--	----	----	-----	---	-----	-----	-------	---	-------	-------	---	---------	---------------	------

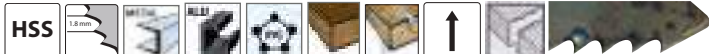

B23	Aço médio, chapa de média espessura, madeira, folheado de madeira decorativa e aço não ferroso.	14	50	HSS	3-35	3-35	2-6	-	2-6	2-6	T118B	5	A-85743	0088381149587	5,00
-----	---	----	----	-----	------	------	-----	---	-----	-----	-------	---	---------	---------------	------



B27	Para cortes curvos em aço médio e não ferroso.	24	50	HSS	-	1-6	1-3	1-3	1-3	1-3	T218A	5	A-85787	0088381149631	6,35
-----	--	----	----	-----	---	-----	-----	-----	-----	-----	-------	---	---------	---------------	------

Corte - Metal



Tipo	Descrição	Dentes por polegada	Comprimento útil (mm)	Qualidades do material	Madeira	Plástico	Alumínio	metal inox	Metal não ferroso	metal	Tipo Classe B	Un. embalagem	Código	EAN	P.V.P (€)
-	Para revestimento de 80 mm e materiais de sanduiche. (lâmina flexível)	25	105	BIM	-	-	-	-	-	1-3	T318AF	5	P-47204	0088381977630	9,90



-	Para tubos finos de materiais não ferrosos e revestimento.	13	105	BIM	-	-	-	-	2,5-6	2,5-6	T318BF	5	P-47210	0088381977647	9,35
---	--	----	-----	-----	---	---	---	---	-------	-------	--------	---	---------	---------------	------



-	Lâmina flexível para chapa fina de aço médio e inoxidável com uma vida útil prolongada.	21	55	BIM	-	-	-	1,2-2	-	1,2-2	T118AF	5	P-47226	0088381977654	7,75
---	---	----	----	-----	---	---	---	-------	---	-------	--------	---	---------	---------------	------

Corte - Especial inox



Tipo	Descrição	Dentes por polegada	Comprimento útil (mm)	Qualidades do material	Madeira	Plástico	Alumínio	metal inox	Metal não ferroso	metal	Tipo Classe B	Un. embalagem	Código	EAN	P.V.P (€)
-	Para aço médio e inoxidável	24	50	CV-HM	-	-	1,5-3	1,5-3	-	1,5-3	T118AHM	1	P-05929	0088381944441	13,40



-	Lâmina flexível para aços médio e inoxidável, metal não ferroso com uma vida útil prolongada	14	55	BIM	-	-	2-3	2-3	-	2-3	T118BF	5	P-47232	0088381977661	7,75
---	--	----	----	-----	---	---	-----	-----	---	-----	--------	---	---------	---------------	------

Corte - Especial plásticos

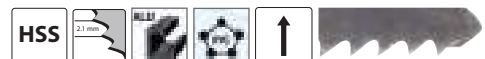
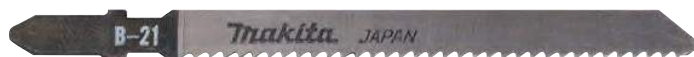

Tipo	Descrição	Dentes por polegada	Comprimento útil (mm)	Qualidades do material	Madeira	Plástico	Alumínio	metal inox	Metal não ferroso	metal	Tipo Classe B	Un. embalagem	Código	EAN	P.V.P (€)
B21	Para trabalhos de acabamento em plásticos e alumínio.	12	75	HSS	-	3-60	1-10	-	-	-	T101A	5	A-85721	0088381149624	8,45

Corte - Especial materiais macios



Tipo	Descrição	Dentes por polegada	Comprimento útil (mm)	Qualidades do material	Madeira	Plástico	Alumínio	metal inox	Metal não ferroso	metal	Tipo Classe B	Un. embalagem	Código	EAN	P.V.P (€)
-	Ideal para papel, cortiça, borracha e couro.	-	75	HCS	-	-	-	-	-	-	T113A	5	A-80416	0088381136952	16,50

Corte - Especial cerâmica e fibra de vidro

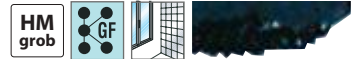

Tipo	Descrição	Dentes por polegada	Comprimento útil (mm)	Qualidades do material	Madeira	Plástico	Alumínio	metal inox	Metal não ferroso	metal	Tipo Classe B	Un. embalagem	Código	EAN	P.V.P (€)
-	Para cerâmica de 5 - 15 mm - corte grosso.	-	54	CV-HM	-	-	-	-	-	-	T130RI-FF	3	P-38788	0088381966696	14,45



-	Para cerâmica de 5 - 20 mm de espessura - corte fino.	-	54	CV-HM	-	-	-	-	-	-	T150RI-FF	3	P-38794	0088381966702	14,45
---	---	---	----	-------	---	---	---	---	---	---	-----------	---	---------	---------------	-------



-	Para fibra de vidro e plásticos reforçados. Dentes de carboneto de tungstênio.	6	75	CV-HM	10-60	-	-	-	-	-	T141HM	3	B-06890	0088381289177	24,00
---	--	---	----	-------	-------	---	---	---	---	---	--------	---	---------	---------------	-------



-	Para fibra de vidro e plásticos reforçados. Dentes de carboneto de tungstênio.	6	105	CV-HM	10-95	-	-	-	-	-	T341HM	3	B-06909	0088381289184	32,00
---	--	---	-----	-------	-------	---	---	---	---	---	--------	---	---------	---------------	-------

Corte - Especial painel de sandwich



Tipo	Descrição	Dentes por polegada	Comprimento útil (mm)	Qualidades do material	Madeira	Plástico	Alumínio	metal inox	Metal não ferroso	metal	Tipo Classe B	Un. embalagem	Código	EAN	P.V.P (€)
-	Ideal para papel, cortiça, borracha e couro.	24	155	BIM	5-145	5-145	-	-	-	-	T718BF	5	P-49644	0088381980098	13,40

Jogos de lâminas a granel

Para um corte rápido e limpo em madeira e plásticos. Especial contraplacado



Tipo	Descrição	Dentes por polegada	Comprimento útil (mm)	Qualidades do material	Madeira	Plástico	Alumínio	metal inox	Metal não ferroso	metal	Tipo Classe B	Un. embalagem	Código	EAN	P.V.P (€)
B10	Jogo de lâminas a granel	9	75	HCS	3-65	3-65	-	-	-	-	T301CD	100	B-07674	0088381335294	99,00

Para uma rápida conclusão do trabalho. Corte limpo



Tipo	Descrição	Dentes por polegada	Comprimento útil (mm)	Qualidades do material	Madeira	Plástico	Alumínio	metal inox	Metal não ferroso	metal	Tipo Classe B	Un. embalagem	Código	EAN	P.V.P (€)
B11	Jogo de lâminas a granel	9	75	HCS	3-60	3-60	-	-	-	-	T101B	100	B-07680	0088381335300	104,00

Para corte rápido em madeira e plásticos. Corte rápido e grosseiro

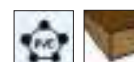

Tipo	Descrição	Dentes por polegada	Comprimento útil (mm)	Qualidades do material	Madeira	Plástico	Alumínio	metal inox	Metal não ferroso	metal	Tipo Classe B	Un. embalagem	Código	EAN	P.V.P (€)
B16	Jogo de lâminas a granel	6	75	HCS	5-65	5-65	-	-	-	-	T144D	100	B-07711	0088381335331	88,00

Para aço médio, inoxidável e plásticos duros. Adequado para chapas finas

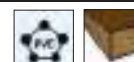

Tipo	Descrição	Dentes por polegada	Comprimento útil (mm)	Qualidades do material	Madeira	Plástico	Alumínio	metal inox	Metal não ferroso	metal	Tipo Classe B	Un. embalagem	Código	EAN	P.V.P (€)
B22	Jogo de lâminas a granel	24	50	HSS	-	1-6	1-3	1-3	-	1-3	T118A	100	B-07733	0088381335355	84,00

Para cortes em madeira e plástico

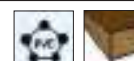

Tipo	Descrição	Dentes por polegada	Comprimento útil (mm)	Qualidades do material	Madeira	Plástico	Alumínio	metal inox	Metal não ferroso	metal	Tipo Classe B	Un. embalagem	Código	EAN	P.V.P (€)
B13	Jogo de lâminas a granel	8	80	HCS	4-65	4-65	-	-	-	-	T111C	100	B-07705	0088381335324	68,00



Tipos de lâminas - Inserção Makita

Corte - Madeira



Tipo	Descrição	Dentes por polegada	Comprimento útil (mm)	Qualidades do material	Madeira	Plástico	Alumínio	metal inox	Metal não ferroso	metal	Tipo Classe B	Un. embalagem	Código	EAN	P.V.P (€)
3	Para todos os tipos de madeira e plástico.	9	60	HCS	3-50	3-50	-	-	-	-	-	5	A-85868	0088381149457	4,45



16	Corte curvo em madeira macia e material isolante.	9	60	HCS	3-50	3-50	-	-	-	-	-	5	792207-9	0088381100342	4,90
----	---	---	----	-----	------	------	---	---	---	---	---	---	----------	---------------	------

Corte rápido - Madeira



Tipo	Descrição	Dentes por polegada	Comprimento útil (mm)	Qualidades do material	Madeira	Plástico	Alumínio	metal inox	Metal não ferroso	metal	Tipo Classe B	Un. embalagem	Código	EAN	P.V.P (€)
8	Corte rápido de todos os tipos de madeira e plástico.	8	60	HCS	4-50	4-50	-	-	-	-	-	5	A-85911	0088381149723	5,55

Corte de acabamento - Madeira



Tipo	Descrição	Dentes por polegada	Comprimento útil (mm)	Qualidades do material	Madeira	Plástico	Alumínio	metal inox	Metal não ferroso	metal	Tipo Classe B	Un. embalagem	Código	EAN	P.V.P (€)
9	Corte limpo e rápido em todos os tipos de madeira e plástico.	8	60	HCS	4-50	4-50	-	-	-	-	-	5	A-85927	0088381149730	7,05



10	Corte limpo e rápido em todos os tipos de madeira e plástico. Especial para contraplacado.	9	60	HCS	4-50	4-50	-	-	-	-	-	5	A-85818	0088381149488	7,30
----	--	---	----	-----	------	------	---	---	---	---	---	---	---------	---------------	------

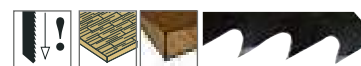

BR3	Lâmina especial para cortes superficiais sem lascas.	9	60	HCS	4-50	-	-	-	-	-	-	5	A-85933	0088381149747	4,45
-----	--	---	----	-----	------	---	---	---	---	---	---	---	---------	---------------	------

Corte - Madeiras duras e contraplacados decorativos



Tipo	Descrição	Dentes por polegada	Comprimento útil (mm)	Qualidades do material	Madeira	Plástico	Alumínio	metal inox	Metal não ferroso	metal	Tipo Classe B	Un. embalagem	Código	EAN	P.V.P (€)
2	Para chapas finas de aço e aço inoxidável.	14	60	HSS	3-50	3-50	2-6	-	2-6	-	-	5	A-85852	0088381149440	5,55



4	Para madeira dura, metal não ferroso e plásticos duros.	9	60	HSS	3-50	3-50	3-6	-	3-6	-	-	5	A-85874	0088381149464	5,55
---	---	---	----	-----	------	------	-----	---	-----	---	---	---	---------	---------------	------

Corte - Madeira



Tipo	Descrição	Dentes por polegada	Comprimento útil (mm)	Qualidades do material	Madeira	Plástico	Alumínio	metal inox	Metal não ferroso	metal	Tipo Classe B	Un. embalagem	Código	EAN	P.V.P (€)
41	Para cortar madeira e plástico sem lascas. Dentes invertidos.	12	60	HSS	3-50	3-50	-	-	-	-	-	5	A-85880	0088381149525	5,80



42	Lâmina especial sem inclinação para um bom acabamento em ambos os lados, laminados e painéis múltiplas.	16	60	HSS	2-50	-	-	-	-	-	-	5	A-85896	0088381149532	9,00
----	---	----	----	-----	------	---	---	---	---	---	---	---	---------	---------------	------

Corte - Metal



Tipo	Descrição	Dentes por polegada	Comprimento útil (mm)	Qualidades do material	Madeira	Plástico	Alumínio	metal inox	Metal não ferroso	metal	Tipo Classe B	Un. embalagem	Código	EAN	P.V.P (€)
1	Para chapas finas de aço e aço inoxidável.	24	60	HSS	-	-	1-3	0,5-3	1-3	-	-	5	A-85802	0088381149433	5,55



5	Para chapas finas de aço e aço inoxidável.	24	42	HSS	-	-	1-3	1-3	1-3	-	-	5	A-85905	0088381149471	6,05
---	--	----	----	-----	---	---	-----	-----	-----	---	---	---	---------	---------------	------

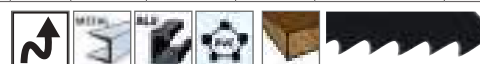

17	Corte curvo em madeira dura, metal não ferroso e plásticos duros.	14	63	HSS	2-50	2-50	2-6	-	2-6	-	-	5	792216-8	0088381100359	8,25
----	---	----	----	-----	------	------	-----	---	-----	---	---	---	----------	---------------	------



Guias de carril e acessórios



Peça para unir dois carris



Guia de carril



Capa para guia de carril

Descrição	Comprimento (m)	Un.	Código	EAN	P.V.P (€)
Peça para unir dois carris	-	1	198885-7	0088381497046	25,00
Guia de carril	1	1	199140-0	0088381528672	45,00
	1,4	1	194368-5	0088381313353	71,00
	1,9	1	194925-9	0088381354790	109,00
	3	1	194367-7	0088381335201	185,00
Capa para guia de carril	1	1	E-05670	0088381567183	46,00
	1,4	1	E-05664	0088381567176	53,00
	1,9	1	E-10920	0088381581523	83,00
	3	1	E-10936	0088381581530	103,00

Adaptador para guia de carril



Modelos	Un.	Código	EAN	P.V.P (€)
4350T/CT/FCT 4351CT/FCT 4329 DJV180/181/182 JV0600	1	193517-1	0088381170659	30,00

Chaves allen



Modelos	Un.	Código	EAN	P.V.P (€)
4326 4327 4328 4329	1	783201-2	0088381101288	1,05
4350T/CT/FCT 4351T/CT/FCT DJV180/181/182	1	783202-0	0088381102667	1,05

Grampo para guia de carril



Modelos	Un.	Código	EAN	P.V.P (€)
Guias de carril	2	194385-5	0088381314084	28,00

Guia lateral + circular (A + B)



Tipo	Modelo	Un.	Código	EAN	P.V.P (€)
A + B	DJV180 DJV181 DJV182	1	193516-3	0088381170666	9,55
A + B	4326 4327 4328 4329 JV0600 JV100D JV103	1	192732-4	0088381148054	8,20

Acessórios

Placa anti-lascas



415524-7

Protetor de base

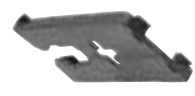

417852-6

Adaptador de aspiração



417853-4

Adaptador de aspiração



192349-3

Tipo	Modelo	Un.	Código	EAN	P.V.P (€)
Placa antilascas	DJV182 4350T/CT/FCT 4351CT/FCT	1	415524-7	0088381131681	0,75
	4322 4323 4324	1	416477-3	0088381148207	0,50
	4329 4350T/CT/FCT 4351T/CT/FCT, DJV180/181/182 JV0600	1	417852-6	0088381177498	2,60
Adaptador de aspiração	4326 4327 4328 4329 JV0600	1	192349-3	0088381126229	7,70
	4350T/CT/FCT 4351CT/FCT DJV180	1	417853-4	0088381170833	1,05

Fresagem



Fresas - Índice

Fresas retas págs. 253 - 254

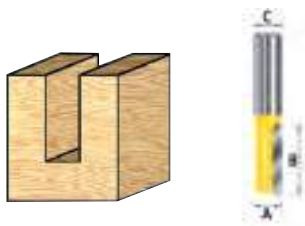

Fresas em V págs. 256

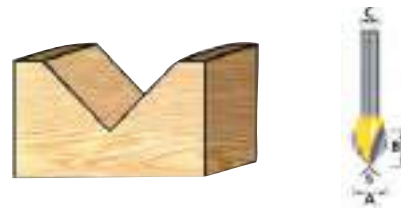

Fresas para painéis pág. 254



Fresas de meia-cana pág. 256



Fresas em U pág. 255

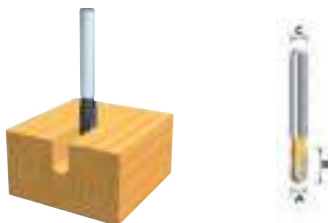

Fresas macho-fêmea pág. 256

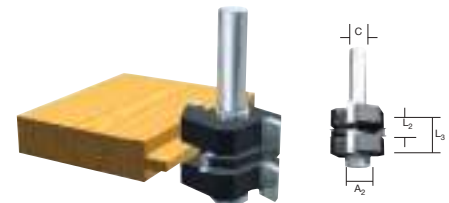

Fresas de corte pág. 255



Fresas para alumínio pág. 257

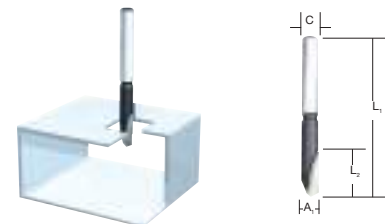

Fresas molduradoras pág. 255

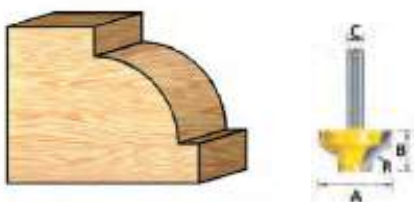

Fresas para 3706, DCO180 e DCO181 pág. 257



Fresas redondas pág. 255



Discos e biscoitos para PJ7000 pág. 258



Fresas biseladoras pág. 256

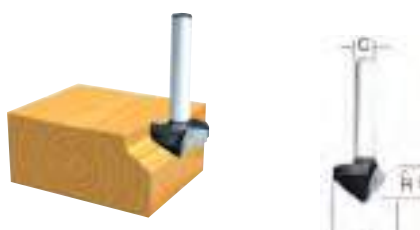

Acessórios para 7104L pág. 258



Fresas para madeira

Caixas de fresas

- Caixas com diferentes tipos de fresas para várias aplicações.

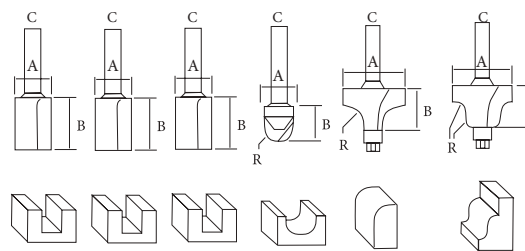
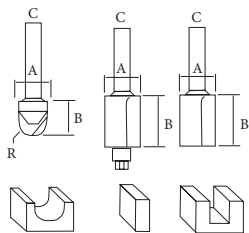

A (mm)	B (mm)	C (mm)	Tipo	Un.	Código	EAN	P.V.P (€)
-	-	6	HM	3	D-30209	0088381352772	21,35
-	-	6	HM				
-	-	6	HM				

A (mm)	B (mm)	C (mm)	R (mm)	Un.	Código	EAN	P.V.P (€)
6	16	8	-	6	D-53540	0088381449915	65,00
10	19	8	-				
12	19	8	-				
12,7	10	8	6,35				
31,8	16,7	8	9,5				
28,6	13	8	4				

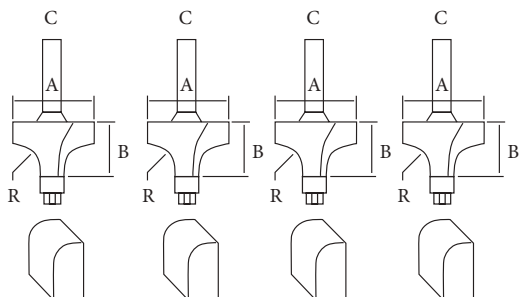

A (mm)	B (mm)	C (mm)	R (mm)	Un.	Código	EAN	P.V.P (€)
19	9,5	8	3,2	4	D-53534	0088381449908	63,00
25,4	13,5	8	6,35				
31,8	16,7	8	9,5				
38,1	19	8	38,1				

Fresas retas de um gume

- Fresas adequadas para pequenas ranhuras.
- Ferramenta de corte de HM.
- Ideal para madeira e contraplacado.

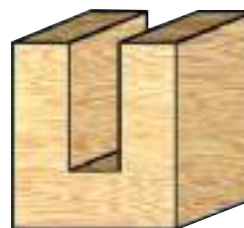

A (mm)	B (mm)	C (mm)	Tipo	Un.	Código	EAN	P.V.P (€)
6	18	6	HM	1	D-09167	0088381184373	9,55
3	8	8	HM	1	D-10001	0088381165044	7,70
4	10	8	HM	1	D-10017	0088381165051	8,50
5	12,7	8	HM	1	D-10023	0088381165068	8,50
6	8	8	HM	1	D-10039	0088381165075	8,75

Fresas para madeira

Fresas retas de dois gumes

- Ferramenta de corte de HM.
- Máxima precisão de corte.
- Ideal para madeira, contraplacados, plásticos e materiais abrasivos.

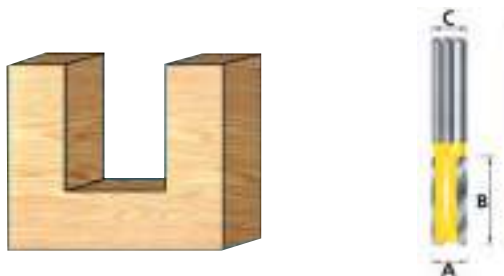

A (mm)	B (mm)	C (mm)	Tipo	Un.	Código	EAN	P.V.P (€)
3	95	6	HM	1	D-09210	0088381181969	17,40
4	10	6	HM	1	D-09226	0088381181976	18,30
5	12	6	HM	1	D-09232	0088381181983	8,75
6	16	6	HM	1	D-09248	0088381182003	8,75
7	25	6	HM	1	D-09254	0088381182010	8,75
8	20	6	HM	1	D-09260	0088381182027	8,75
9	25	6	HM	1	D-09276	0088381182034	9,00
10	25	6	HM	1	D-09282	0088381182041	9,00
12	32	6	HM	1	D-09298	0088381182058	9,55
15	20	6	HM	1	D-09307	0088381182065	10,80
20	20	6	HM	1	D-09313	0088381182072	12,60
6	19	8	HM	1	D-10051	0088381165099	10,30
8	20	8	HM	1	D-10067	0088381165105	11,35
10	20	8	HM	1	D-10285	0088381165327	16,50
12	20	8	HM	1	D-10291	0088381165334	18,55
14	20	8	HM	1	D-10300	0088381165341	21,00
15	20	8	HM	1	D-10316	0088381165358	21,00
16	20	8	HM	1	D-10322	0088381165365	22,00
18	20	8	HM	1	D-10338	0088381165372	25,00
20	20	8	HM	1	D-10344	0088381165389	24,00
22	20	8	HM	1	D-10350	0088381165396	26,00
24	20	8	HM	1	D-10366	0088381165402	28,00
25	20	8	HM	1	D-10372	0088381165419	28,00
8	30	12	HM	1	D-10176	0088381165211	11,85
10	30	12	HM	1	D-10182	0088381165228	12,90
10	35	12	HM	1	D-10388	0088381165426	21,00
12	32	12	HM	1	D-10198	0088381165235	12,90
15	35	12	HM	1	D-10419	0088381165457	25,00
16	35	12	HM	1	D-10425	0088381165464	30,00
18	35	12	HM	1	D-10431	0088381165471	28,00
20	35	12	HM	1	D-10447	0088381165488	31,00
22	35	12	HM	1	D-10453	0088381165495	32,00
24	35	12	HM	1	D-10469	0088381165501	32,00
25	35	12	HM	1	D-10475	0088381165518	32,00

Fresas para painéis

- Ferramenta de corte HM.
- Para a fresagem de painéis. Com ponta de broca para penetração rápida no material.



A (mm)	B (mm)	C (mm)	Tipo	Un.	Código	EAN	P.V.P (€)
6	19	6	HM	1	D-09335	0088381182096	12,90
12	25,4	12	HM	1	D-10584	0088381165624	14,95

Fresas duplas para painéis

- Ferramenta de corte HM.
- Para a fresagem de painéis do contraplacado superior e inferior ao mesmo tempo.
- Ponta de broca para penetração rápida.

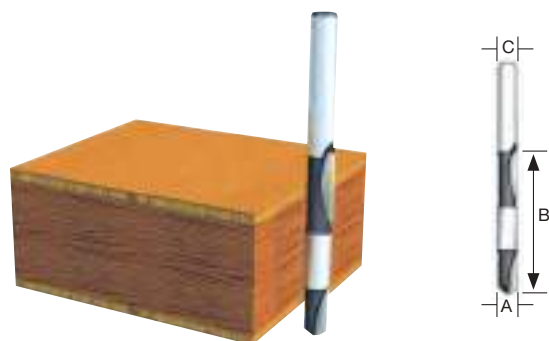

A (mm)	B (mm)	C (mm)	Tipo	Un.	Código	EAN	P.V.P (€)
6	40	6	HM	1	D-09341	0088381182102	24,00
8	55	8	HM	1	793061-4	0088381108225	32,00

Fresas para madeira

Fresas em "U".

- Ferramenta de corte HM.
- Para realizar qualquer motivo decorativo.
- Indicada para madeira maciça e materiais abrasivos.



A (mm)	B (mm)	C (mm)	Tipo	Un.	Código	EAN	P.V.P (€)
6	13	6	HM	1	D-09329	0088381182089	12,90

Fresas de corte com rolamento

- Ferramenta de corte HM.
- Com rolamento para ser usado como guia.
- Perfeita para copiar peças de trabalho com desbaste pesado.
- Para madeira maciça e materiais abrasivos.

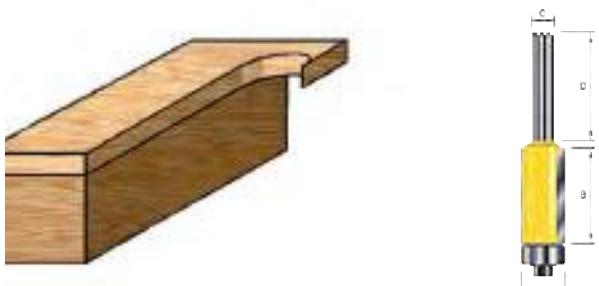

A (mm)	B (mm)	C (mm)	Tipo	Un.	Código	EAN	P.V.P (€)
9,5	25,4	6	HM	1	D-09472	0088381182232	15,20
12,7	38,1	12	HM	1	D-10497	0088381165532	21,00

Redonda com rolamento

- Ferramenta de corte de HM.
- Fresa com rolamento inferior, ideal para cantos.
- Para madeira maciça e materiais abrasivos.



A (mm)	B (mm)	R (mm)	C (mm)	Tipo	Un.	Código	EAN	P.V.P (€)
15	7	3	6	HM	1	D-09422	0088381182188	17,50
21	10	6	6	HM	1	D-09444	0088381182201	22,00

Fresa para molduras sem rolamento

- Ferramenta de corte de HM.
- Fresas para cantos e ranhuras.
- Ideal para madeiras maciças e materiais abrasivos.

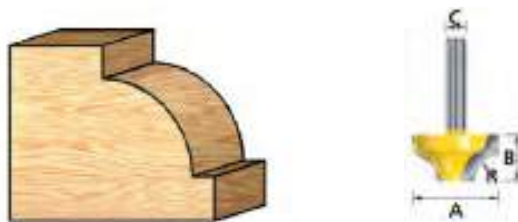

A (mm)	B (mm)	R (mm)	C (mm)	Tipo	Un.	Código	EAN	P.V.P (€)
16	9	4	6	HM	1	D-09357	0088381182119	19,55
25	13	8	6	HM	1	D-09363	0088381182126	24,00

Fresa para molduras

- Ferramenta de corte HM.
- Fresas de perfilagem e moldurar com ângulo convexo.
- Para madeira maciça.

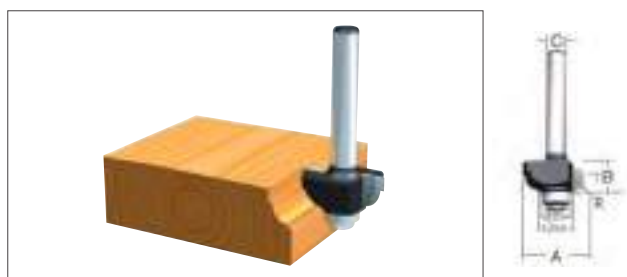

A (mm)	B (mm)	R (mm)	C (mm)	Tipo	Un.	Código	EAN	P.V.P (€)
20	10	2,5	6	HM	1	D-09575	0088381182331	25,00
22	10	3	6	HM	1	D-09553	0088381182317	26,00
26	12	3	6	HM	1	D-09581	0088381182348	24,00
31,75	38,1	9,53	6	HM	1	D-11829	0088381166867	65,00

Fresa para molduras com rolamento

- Ferramenta de corte HM.
- Similar à fresa de arredondamento, mas com um rolamento menor, dando uma forma mais decorativa.
- Para madeira maciça e materiais abrasivos.

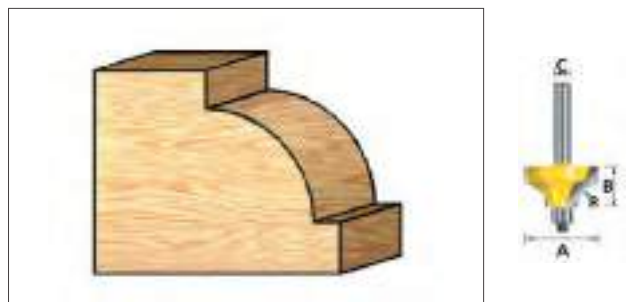

A (mm)	B (mm)	R (mm)	C (mm)	Tipo	Un.	Código	EAN	P.V.P (€)
20	10	4	6	HM	1	D-09525	0088381182287	18,55
26	12	7	6	HM	1	D-09547	0088381182300	22,00

Fresas para madeira

Biseladora com rolamento

- Ferramenta de corte HM.
- Fresas perfeitas para chanfrar, fácil e rapidamente graças ao rolamento.
- Para madeira maciça.



A (mm)	B (mm)	C (mm)	Tipo	Un.	Código	EAN	P.V.P (€)
20	11	6	HM	1	D-09494	0088381182256	21,00
26	12	6	HM	1	D-09488	0088381182249	21,00

Macho-fêmea (macho)

- Ferramenta de corte HM.
- Para a montagem de molduras (macho).
- Para madeira maciça.

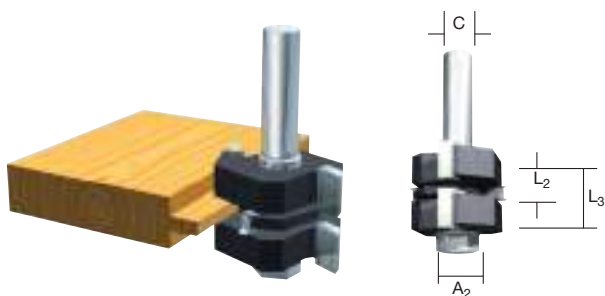

A (mm)	A1 (mm)	L2/L3 (mm)	C (mm)	Tipo	Un.	Código	EAN	P.V.P (€)
38	27	4/20	12	HM	1	D-12027	0088381167062	41,00



Meia-cana

- Ferramenta de corte HM.
- Para fresagem de cantos de móveis, gavetas... com perfil convexo.
- Para madeira maciça.

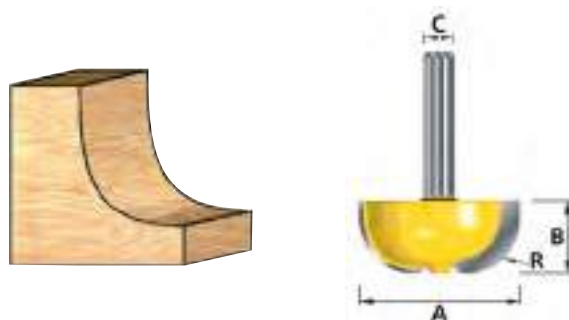

A (mm)	B (mm)	R (mm)	C (mm)	Tipo	Un.	Código	EAN	P.V.P (€)
20	8	4	6	HM	1	D-09400	-	25,00
25	13	8	6	HM	1	D-09416	0088381182171	24,00

Fresas em "V".

- Ferramenta de corte HM.
- Perfeita para ranhurar, chanfrar ou fresar com precisão.
- Adequada para madeira maciça, alucobond e materiais abrasivos.



A (mm)	B (mm)	R (°)	C (mm)	Tipo	Un.	Código	EAN	P.V.P (€)
19	20	60°	6	HM	1	D-09391	0088381182157	23,00
20	15	30°	6	HM	1	D-09379	0088381182133	23,00
20	15	45°	6	HM	1	D-09385	0088381182140	22,00
12,7	12,7	90°	8	HM	1	D-10687	0088381165723	15,95
15,9	12,7	90°	8	HM	1	D-10693	0088381165730	18,55
12,7	12,7	90°	12	HM	1	D-10702	0088381165747	15,95
15,9	12,7	90°	12	HM	1	D-10718	0088381165754	19,05
32	22	90°	12	HM	1	D-10746	0088381165785	31,00

Fresas para perfurar alumínio

- Ferramenta de corte HM.
- Para perfuração de alumínio.
- Também adequada para recortes em alumínio.

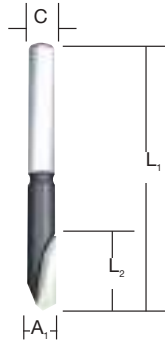

A1/A2 (mm)	L1 (mm)	L2 (mm)	C (mm)	Tipo	Un.	Código	EAN	P.V.P (€)
6	65	30	6	HM	1	D-16988	0088381194761	10,80

Fresas para 3706, DCO180 e DCO181

Fresas para Gesso cartonado ou Pladur



Inserção (mm)	Modelo	Un.	Código	EAN	P.V.P (€)
3,18 (1/8")	3706 DCO180 DCO181	1	733240-2	-	3,60
6,35 (1/4")		1	733232-1	0088381160544	10,80
3,18 (1/8") (multiusos)		1	193483-2	0088381163927	5,15



Acessórios para PJ7000 e 3901

Discos HM



Ø (mm)	Modelo	Un.	Código	EAN	P.V.P (€)
100	PJ7000 3901	1	B-20644	0088381377133	24,00

Lamelas

- Facilitam a união de painéis, mais fáceis de usar, permitem uma folga (tolerância) entre as tábuas a unir, mais seguras e mais fortes graças aos biscoitos de alta resistência.

Embalagens de 1000 peças. Alta qualidade. Grande dureza.



Modelo	Medida (mm)	Grão	Un.	Código	EAN	P.V.P (€)
50 x 20 x 4	3901 n.º 10	1000 peças	1	P-08844	0088381921206	46,00
55 x 25 x 4	3901 n.º 20	1000 peças	1	P-08850	0088381921213	46,00

Acessórios para 7104

Correntes



Tipo	Medida (mm)	Modelo	Un.	Código	EAN	P.V.P (€)
-	15	7104L	1	A-16564	0088381131612	366,00
-	16,5		1	A-16570	0088381131629	364,00
-	18,0		1	A-16586	0088381131636	384,00
-	21		1	A-16592	0088381131643	430,00
-	24,0		1	A-16601	0088381131650	493,00
Usar com o pinhão cód. 221502-5 e barra cód. 122235-4.	30		1	A-16617	0088381131667	757,00

Óleo de corrente



Un.	Código	EAN	P.V.P (€)
1	181434-7	0088381194747	1,25

Barra-guia



Corrente	Descrição Tipo/Utilização	Un.	Código	EAN	P.V.P (€)
30 mm	Usar ao montar a corrente de 30 mm.	1	122235-4	0088381122764	319,00

Pinhão



Corrente	Descrição Tipo/Utilização	Un.	Código	EAN	P.V.P (€)
30 mm	Usar ao montar a corrente de 30 mm.	1	221502-5	-	17,00



Guia angular



Modelo	Un.	Código	EAN	P.V.P (€)
3901	1	122473-8	0088381127530	38,00
PJ7000 DPJ180 BPJ180	1	123149-0	0088381443173	19,90

Chaves de pivôs 20



Modelos	Un.	Código	EAN	P.V.P (€)
3901 PJ7000 DPJ180 BPJ180	1	782401-1	0088381101240	0,90

Casquilhos cónicos



Modelo	Ø (mm)	Descrição	Un.	Código	EAN	P.V.P (€)
3707FC	6	-	1	763607-0	0088381114806	2,60
	6,35 20,00	-	1	763608-8	0088381102292	3,10
3709 3710 4403	6	-	1	763662-2	0088381431606	3,80
	6,35 (1/4")	-	1	763663-0	0088381207294	4,10
RP1800 RP2300FC	1/2"	-	1	763622-4	0088381102315	15,45
	12	-	1	763628-2	0088381114813	15,45
	13	-	1	763632-1	0088381118538	24,00
3601B	12	-	1	763601-2	0088381123945	38,00
DRT50 RP0900 RT0700C RT0702C	6	-	1	763636-3	0088381142830	10,80
	6,35 (1/4")	-	1	763637-1	0088381102353	9,00
	8	-	1	763618-5	0088381114820	2,60
RP0910 RP110C	6	Com porca	1	193180-0	0088381156714	24,00
	8	Com porca	1	193178-7	0088381156721	21,00

Placa de ajuste



Modelos	Un.	Código	EAN	P.V.P (€)
3901 PJ7000 DPJ180	1	415579-2	0088381155038	7,50

Saco coletor de pó



Modelos	Un.	Código	EAN	P.V.P (€)
3901	1	122474-6	0088381127547	7,10
PJ7000 DPJ180 BPJ180	1	123150-5	0088381403092	6,55

Chaves



Redução (mm)	Modelo	Un.	Código	EAN	P.V.P (€)
8	RP0910 RP110C RP0900	1	781213-9	0088381102520	2,05
13	DRT50 RT0700C RT0702C RP0900	1	781006-4	0088381102407	1,80
17	3709 3710 3706 3707FC RP0910 RP110C 4403	1	781008-0	0088381102414	1,80
22	DRT50 RP0900 RT0700C RT0702C	1	781011-1	0088381102438	2,05
23	3601B	1	781012-9	0088381102445	2,15
24	RP1800 RP2300FC	1	781030-7	0088381151559	2,60

Casquilho redutor



Redução (mm)	Modelo	Un.	Código	EAN	P.V.P (€)
12 - 6"	3601B RP1800 RP2300FC	1	763801-4	008838114646	3,10
12 - 8"		1	763804-8	008838114653	3,10
12 - 10"		1	763807-2	0088381124003	3,60
12 - 1/4"		1	763803-0	0088381102360	3,10

Porca



Modelos	Un.	Código	EAN	P.V.P (€)
3707FC 3709 3710 4403	1	763606-2	0088381123952	3,85
RP0900 RT0700C RT0702C	1	763615-1	0088381123969	3,10
RP0910 RP110C	1	763652-5	0088381170352	4,10
3612 3612C	1	763629-0	0088381123983	6,20
RP1800 RP2300FC	1	763674-5	-	6,70

Acessórios para 3706, DCO180 e DCO181



Guia circular



Modelos	Un.	Código	EAN	P.V.P (€)
3706 DCO180 DCO181	1	193448-4	0088381163958	24,00

Coletor de pó



Modelos	Un.	Código	EAN	P.V.P (€)
3706 DCO180 DCO181	1	193449-2	0088381160490	6,70

Casquilhos cónicos



Medida (mm)	Modelo	Un.	Código	EAN	P.V.P (€)
3,18	3706	1	324149-5	0088381161060	11,00
6,35 (1/4")		1	763608-8	0088381102292	3,10
3,18	DCO180 DCO181	1	763677-9	0088381468824	12,35
6,35 (1/4")		1	763676-1	0088381469012	14,95

Porca



Modelos	Un.	Código	EAN	P.V.P (€)
3706	1	763606-2	0088381123952	3,85
DCO180 DCO181	1	763258-9	-	5,40

Guias de molde

1. Para os modelos 3709, 3710, 3707FC, DRT50, RT0700C, RT0702C.

1



A (mm)	B (mm)	C (mm)	Modelos	Un.	Código	EAN	P.V.P (€)
8,0	10,0	9,5	3709 3710 3707FC DRT50 RT0700C RT0702C	1	343577-5	0088381115681	0,75

2. Para os modelos DRT50, RP0900, RP1800X, RP2300FCX, RT0700* Y RT0702C.

2



A (mm)	B (mm)	C (mm)	Modelos	Un.	Código	EAN	P.V.P (€)
7,7	9,5	11,5	DRT50 RP0900 RP1800X RP2300FCX RT0700* RT0702C*	1	164379-4	0088381111676	13,90
9,0	11,0	13,0		1	164775-6	0088381111720	12,90
10,0	12,0	9,0		1	164388-3	0088381156356	11,85
11,0	12,7	13,0		1	164776-4	008838112062	13,40
14,5	16,0	13,0		1	344364-5	0088381141222	2,60
18,0	20,0	13,0		1	164393-0	0088381111683	16,00
24,0	27,0	13,0		1	164470-8	0088381111690	13,00
25,0	29,0	150,0		1	163080-8	0088381111645	10,80
27,0	30,0	13,0		1	164471-6	0088381111706	11,05
37,0	40,0	11,5		1	165046-4	0088381161237	16,00

* Com base de superfície

3. Para os modelos RP0910, RP1110C

3



A (mm)	B (mm)	C (mm)	Modelos	Un.	Código	EAN	P.V.P (€)
9,0	11,0	11,5	RP0910 RP1110C	1	193331-5	0088381159906	13,40
10,5	12,0	14,0		1	193332-3	0088381156615	9,55
14,5	16,0	11,5		1	193334-9	0088381159920	10,80
18,0	20,0	13,0		1	193335-7	0088381159937	16,20
22,0	14,0	13,0		1	193340-4	0088381159982	13,40
24,0	27,0	13,0		1	193336-5	0088381159944	12,35
27,0	30,0	13,0		1	193338-1	0088381159968	12,90
37,0	40,0	13,0		1	193339-9	0088381159975	14,40

Guia de molde completa

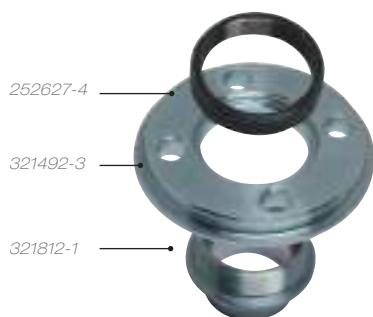

Modelo	Ø (mm)	Modelos	Un.	Código	EAN	P.V.P (€)
Porca	M30	DRT50 RP0900 RP1800X RP2300FCX RT0700* RT0702C*	1	252627-4	0088381111782	10,30
Adaptador	-		1	321492-3	0088381111799	15,45
Casquilho	25,4 mm		1	321812-1	0088381111805	10,05

Guias de carril e acessórios



Peça para unir dois carris



Guia de carril



Capa para guia de carril

Descrição	Comprimento (m)	Un.	Código	EAN	P.V.P (€)
Peça para unir dois carris	-	1	198885-7	0088381497046	25,00
Guia de carril	1	1	199140-0	0088381528672	45,00
	1,4	1	194368-5	0088381313353	71,00
	1,9	1	194925-9	0088381354790	109,00
	3	1	194367-7	0088381335201	185,00
Capa para guia de carril	1	1	E-05670	0088381567183	46,00
	1,4	1	E-05664	0088381567176	53,00
	1,9	1	E-10920	0088381581523	83,00
	3	1	E-10936	0088381581530	103,00

Grampos para guia de carril



Descrição	Un.	Código	EAN	P.V.P (€)
Jogo de fixação para guia de carril.	2	194385-5	0088381314084	28,00

Adaptador para guia de carril



Modelos	Un.	Código	EAN	P.V.P (€)
RP0910 RP110C RP1800 RP2300FC RP0900 RT0700* RT0702C*	1	194579-2	0088381352611	36,00

* Com base de superfície



Acessórios para fresadora multifunções RT0700C/ RT0702C/ DRT50

Base reta

Placa para base



* Inclui placa base

Descrição	Modelo	Un.	Código	EAN	P.V.P (€)
Base	DRT50 RT0700C RT0702C	1	196613-4	0088381446136	26,00
Placa para base		1	454842-8	-	2,40



Base para superfície

Placa para base



* Inclui placa base

Descrição	Modelo	Un.	Código	EAN	P.V.P (€)
Base	DRT50 RT0700C RT0702C	1	195563-0	0088381376099	70,00
Placa para base		1	450819-1	-	3,00



Base inclinável de 30° a 45°

Placa para base



* Inclui placa base

Descrição	Modelo	Un.	Código	EAN	P.V.P (€)
Base	DRT50 RT0700C RT0702C	1	198987-9	0088381525848	31,00
Placa para base		1	413150-6	-	2,50



Base eixo deslocado

Placa para base



* Inclui placa base

Descrição	Modelo	Un.	Código	EAN	P.V.P (€)
Base	DRT50 RT0700C RT0702C	1	195562-2	0088381376082	82,00
Placa para base		1	413148-3	-	4,50



Guias de corte

1



2



3



Tipo	Modelo	Un.	Código	EAN	P.V.P (€)
1	3709 3710 DRT50 RT0700C RT0702C	1	122703-7	0088381207300	3,50
2	RP1800X RP2300FCX	1	123022-4*	0088381115643	13,00
3	RP0900 RT0700C**	1	STEX122385	0088381111164	36,00
	3601B	1	122343-1	0088381111621	25,00

* Requer a utilização de batente ajustável

** Com base de superfície

Parafuso de fixação



Descrição	Un.	Código	EAN	P.V.P (€)
Define a profundidade quando se utiliza a fresadora invertida sobre uma mesa.	1	266491-7	-	2,05

Bases



Base reta



Base inclinada

Tipo	Modelo	Un.	Código	EAN	P.V.P (€)
Base reta	3707/F/FC	1	123544-4	-	28,00
Base inclinada		1	193904-4	0088381164726	46,00
Base reta com borracha	3709 3710	1	194268-9	0088381248846	13,10
Base reta		1	194267-1	0088381248839	15,50
Base inclinada		1	194270-2	0088381248860	41,00

Batente ajustável



* Para a instalação de um guia de corte.

Modelos	Un.	Código	EAN	P.V.P (€)
RP1800 RP2300FC	1	122700-3	0088381347327	17,50
DRT50 RT0700C RT0702C	1	195564-8	0088381411530	6,10

Adaptadores de aspiração



Modelos	Un.	Código	EAN	P.V.P (€)
3612 3612C	1	415412-8	0088381155014	5,00
RP1800X RP2300FCX	1	194934-8	0088381356756	10,80
DRT50* RP0900 RT0700C* RT0702C*	1	194733-8	0088381358972	2,25
DRT50 RT0700C RT0702C	1	195559-1	0088381411295	3,35

* Com base de superfície

Guias paralelas



Guia paralela com ajuste milimétrico

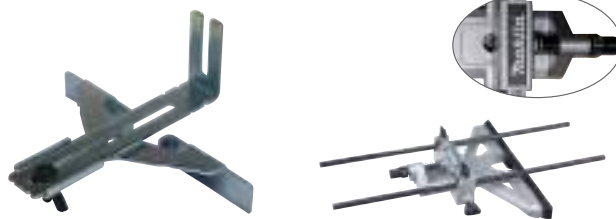

195136-9

Modelos	Un.	Código	EAN	P.V.P (€)
3707FC 3709 3710 DRT50 RT0700C RT0702C	1	122391-0	0088381115674	6,30
RP0900 RP0910 RP1100C	1	164834-6	0088381111737	4,25
3612C 3612	1	342428-9	0088381115667	6,85
DRT50* RP0900 RT0700* RT0702C* RP1100C RP1800 RP2300FCX	1	195136-9	0088381360623	53,00

* Com base de superfície

Decapar





• **HG5030K**



• **HG6031VK**



• **HG6531CK**







Acessórios para Decapadores para HG5030, HG6031V e HG6531V

Descrição		HG5030K	HG6031VK	HG6531VK	Un.	Código	EAN	P.V.P (€)
		✓	✓	✓	1	PR00000029	0088381527934	7,65
		✓	✓	✓	1	PR00000028	0088381527927	7,65
		✓	✓	✓	1	PR00000030	0088381527941	9,85
		-	✓	✓	1	PR00000031	0088381527958	8,20
		-	-	✓	1	PR00000039	0088381528030	9,00
		-	-	✓	1	PR00000032	0088381527965	16,30
		-	-	✓	1	PR00000033	0088381527972	17,90
		-	-	✓	1	PR00000034	0088381527989	7,65
		✓	✓	✓	1	PR00000035	0088381527996	10,35
		✓	✓	✓	1	PR00000041	0088381528054	20,75

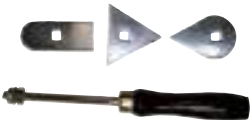

Acessórios para Decapadores para HG5012, HG551 e HG651CK

Descrição	HG5012K	HG551VK	HG651CK	Un.	Código	EAN	P.V.P (€)
 Bocal de redução ø 20 mm	-	✓	✓	1	P-71439	0088381702027	7,25
 Bocal refletor	✓	✓	✓	1	P-71445	0088381702034	7,45
 Bocal para soldadura por sobreposição	-	-	✓	1	P-71489	0088381702072	11,35
 Conjunto raspador	✓	✓	✓	1	P-71554	0088381702140	19,55
 Refletor para soldadura	-	-	✓	1	P-71495	0088381702089	13,90

Plástico de soldadura



Características	Comprimento (mm)	Un.	Código	EAN	P.V.P (€)
Plástico polipropileno	230	20	P-71510	0088381702102	24,00
Plástico polietileno			P-71526	0088381702119	24,00
Plástico acrilonitrilo			P-71532	0088381702126	24,00



Parafusos e pregos



Ampla gama de aparafusadoras autoalimentadas, pregadoras e agrafadoras Makita

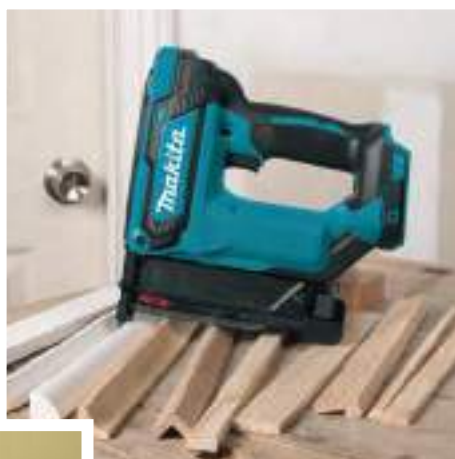

Pente de parafusos para auto alimentadas



Parafuso para Paredes de gesso cartonado sobre guia metálica

Ø (mm)	Comprimento (mm)	Tipo de rosca	Tratamento	BFR440	BFR550	6842	6844	un.	Código	EAN	P.V.P. (€)
3,5	25	Fina	Fosfatado	✓	✓	X	X	1000	F-31227	0088381291781	15,20
3,5	35			✓	✓	X	X		F-31230	0088381291712	16,75
3,9	25			✓	✓	✓	X		F-30913	0088381291477	15,70
3,9	41			✓	✓	✓	X		F-31166	0088381291729	20,10

Parafuso para Paredes de gesso cartonado sobre guia de madeira

Ø (mm)	Comprimento (mm)	Tipo de rosca	Tratamento	BFR440	BFR550	6842	6844	un.	Código	EAN	P.V.P. (€)
3,9	41	Grossa	Fosfatado	✓	✓	✓	X	1000	F-31182	0088381291743	26,00
3,9	55			X	X	✓	✓		F-31140	0088381291705	21,00

Parafuso anticorrosão

Ø (mm)	Comprimento (mm)	Tipo de rosca	Tratamento	BFR440	BFR550	6842	6844	un.	Código	EAN	P.V.P. (€)
3,9	32	D/G	Anticorrosão	✓	✓	X	X	1000	P-38283	0088381973991	29,00



Parafusos para aparafusadora autoalimentada - AR410HR

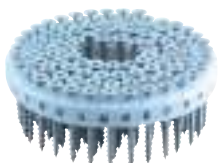

Ø cana (mm)	Ø cabeça (mm)	Comprimento (mm)	Tipo	Rosca	Modelo	un. /caixa	Código	EAN	P.V.P. (€)
3,5	8,2	28	PH2	Fina	AR410HR	2000	F-32843	0088381293402	35,00
3,5		41		Fina			F-32856	0088381293419	39,00
3,8		25		Grossa			F-32869	0088381293426	32,00
3,8		28		Grossa			F-32872	0088381293433	33,00
3,8		32		Grossa			F-32885	0088381293440	35,00
3,8		41		Grossa			F-32898	0088381293457	41,00

Pregos 0,6 mm (23Ga) Inoxidável - DPT351 e DPT353



Ø (mm)	Comprimento (mm)	Tipo	Calibre	Material	Modelos	un. /caixa	Código	EAN	P.V.P. (€)
0,6	18	Pin	23Ga	Inox	DPT351 DPT353	10 000	F-32142	0088381292702	25,00
	25						F-32155	0088381292719	29,00
	30						F-32168	0088381292726	33,00
	35						F-32171	0088381292733	37,00

Pregos 0,6 mm (23Ga) Aço - DPT351 e DPT353



Ø (mm)	Comprimento (mm)	Tipo	Calibre	Material	Modelos	un. /caixa	Código	EAN	P.V.P. (€)
0,6	18	Pin	23Ga	Aço	DPT351 DPT353	10 000	F-31825	0088381292382	13,40
	25						F-31838	0088381292399	14,40
	30						F-31841	0088381292405	16,20
	35						F-31854	0088381292412	18,00

Pregos 1,2 mm (18Ga) - AF505N, DBN500 e DFN350



Ø (mm)	Comprimento (mm)	Tipo	Calibre	Modelos	un. /caixa	Código	EAN	P.V.P. (€)
1,2	20	Brad	18Ga	AF505N DBN500 DFN350*	5000	P-45923	0088381976367	11,55
	25					P-45939	0088381976374	13,20
	30					P-45945	0088381976381	15,40
	40					P-45951	0088381976398	16,50
	50					P-45967	0088381976404	19,25

*Apenas pregos de até 30 mm

Pregos multimaterial - AN250HC

- O prego de betão tem uma guia (casquilho de plástico) que impede a inclinação do prego e permite um disparo reto, pregos de 19 a 25 mm e sem inclinação.
- Recomendações: Não pregar diretamente no betão, introduzir o prego a pelo menos 10 cm da extremidade do betão, introduzir os pregos a pelo menos 10 cm de distância.



Ø cana (mm)	Ø cabeça (mm)	Comprimento (mm)	Tipo	Modelos	un. /caixa	Código	EAN	P.V.P. (€)
2,5	6,3	19	Liso	AN250HC	1000	F-33562	0088381294126	44,00
2,5		22				F-33575	0088381294133	53,00
2,5		25				F-33588	0088381294140	55,00
3		19				F-33591	0088381294157	84,00

Pregos multimaterial. Cada caixa contém uma lata de gás. - GN420C



Ø (mm)	Comprimento (mm)	Qualidade	Tipo	un. GÁS	Modelos	un. /caixa	Código	EAN	P.V.P. (€)
3,1	15	Premium	Para todos os tipos de material	1	GN420C	1000	196285-5	0088381422932	82,00
	17						196286-3	0088381422949	82,00
	22						196287-1	0088381422956	82,00
	27						196288-9	0088381422963	82,00
	32						196289-7	0088381422970	82,00



2,6	20	Padrão	Para todos os materiais, exceto betão	1	GN420C	1000	196290-2	0088381422987	76,00
	25						196291-0	0088381422994	76,00
	30						196292-8	0088381423007	76,00
	35						196293-6	0088381423014	76,00
	40						196294-4	0088381423021	76,00

Carregador de pregos - GN420C



Modelos	un. /caixa	un. por carga	Código	EAN	P.V.P. (€)
GN420C	1	20	196246-5	0088381417891	201,00

Agrafos

Agrafos de 90 - AT638



Largura dos agrafos (mm)	Comprimento (mm)	Tipo	Modelos	un. /caixa	Código	EAN	P.V.P. (€)
1/4"	15	18Ga	AT638	5000	P-45864	0088381976305	14,85
	18				P-45870	0088381976312	15,95
	25				P-45886	0088381976329	19,80
	30				P-45892	0088381976336	23,00
	35				P-45901	0088381976343	25,00
	38				P-45917	0088381976350	28,00

Agrafos para máquinas a bateria



Largura dos agrafos (mm)	Comprimento (mm)	Modelos	un. caixa	Código	EAN	P.V.P. (€)
--------------------------	------------------	---------	-----------	--------	-----	------------

DST221

10	10	DST221	5000	F-32647	0088381293204	13,90
	13			F-32650	0088381293211	12,35
	16			F-32663	0088381293228	16,50
	19			F-32676	0088381293235	18,55
	22			F-32689	0088381293242	19,55

ST113D e DST112

10	7	ST113D DST112	25000	F-81518	0088381342308	21,50
	10		15000	F-81521	0088381342322	13,50

Protetor de ponta DPT350 + DPT351



Descrição	un.	Código	EAN	P.V.P. (€)
Evita marcar a madeira durante a pregagem.	1	419525-7	0088381341097	1,45

Recipiente de óleo



Conteúdo	Modelos	un.	Código	EAN	P.V.P. (€)
30 ml	Todos	1	181434-7	0088381194747	1,25



Acessórios Diversos

Botija de gás



Modelos	un.	Código	EAN	P.V.P. (€)
GN900 GN420C	1	242094-1	0088381415712	16,50

Botija de gás



Modelo	un.	Código	EAN	P.V.P. (€)
GF600	1	242088-6	0088381401968	14,40

Óculos de proteção



Modelos	un.	Código	EAN	P.V.P. (€)
Todos	1	195246-2	0088381365413	4,40

Acessórios para alta pressão

Mangueiras - AC310H



B-80014

Conteúdo	Modelo	un.	Código	EAN	P.V.P. (€)
Mangueira 30 m	AC310H	1	B-80020	0088381350761	295,00
Mangueira 15 m		1	B-80014	0088381350754	201,00
Mangueira 7,5 m		1	B-80036	0088381350778	164,00

Óleo lubrificante



Modelos	un.	Código	EAN	P.V.P. (€)
GN900 GN420C	1	242077-1	0088381351973	10,80

Produto de limpeza



Modelos	un.	Código	EAN	P.V.P. (€)
GN900 GN420C	1	242075-5	0088381351966	19,55

Kit de limpeza



Modelos	un.	Código	EAN	P.V.P. (€)
GN900 GN420C GF600	1	194852-0	0088381351959	45,00

Carrinho de transporte - AC310H



Conteúdo	Modelo	un.	Código	EAN	P.V.P. (€)
Carrinho de transporte	AC310H	1	HY00000212	0088381351188	193,00

Aspiração



HEPA
filtro



Ampla gama de aspiradores a bateria. Potentes - Leves - Manejáveis.



LXT
Lithio-ion EXTREMA TECNOLOGIA

XGT

CXT



18V
LITHIO-ION

BL
MOTOR

CXT

HEPA
filtro



AWS

Para mais informações, consulte o catálogo de ferramentas.



Mecanismo de limpeza do saco de pó de papel para eficiência laboral (apenas DVC660/DVC665)

Mesmo ao aspirar o pó de betão, ele tende a entupir os filtros. A ativação deste mecanismo permite recolher aproximadamente 4,0 L, 70 % da capacidade do saco de pó de papel. (aprox. 3,0 L [50 %] quando não ativado)

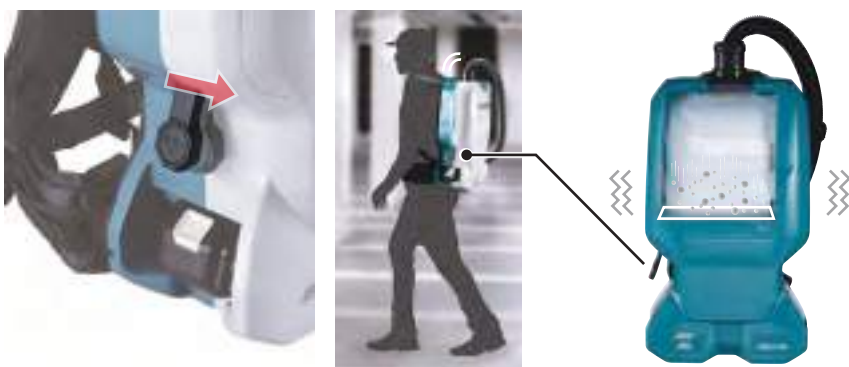

Este mecanismo pode ser acionado:

- Automaticamente pela vibração causada ao caminhar.
- Manualmente, acionando uma alavanca lateral.

Comando controlador



Tecnologia de ligação sem fios



• A função de ativação sem fios automática permite um funcionamento limpo e prático. Ao ligar a ferramenta compatível com o aspirador, pode acionar o aspirador juntamente com o arranque da máquina.



• O AWS está ligado à ferramenta elétrica através de Bluetooth.

• A marca e os logótipos Bluetooth® são marcas comerciais registadas da propriedade da Bluetooth SIG, Inc. e qualquer uso de tais marcas pela Makita é realizado sob licença. Outras marcas e nomes comerciais são propriedade dos seus respetivos proprietários.

O ar de saída é tão limpo como o do filtro do ar.

O filtro HEPA é usado como filtro principal para capturar partículas muito finas de uma forma eficaz.



O eficiente sistema de filtragem HEPA de três estágios captura 99,97 % das partículas com 3 micrones ou mais.



DVC660/DVC665

DVC261/DVC265



Acessórios para aspiradores

DVC150L
DVC154L
DVC155LZX2
DVC157LZX3



DVC860L
DVC862L
DVC864L



DVC260
DVC261
DVC265





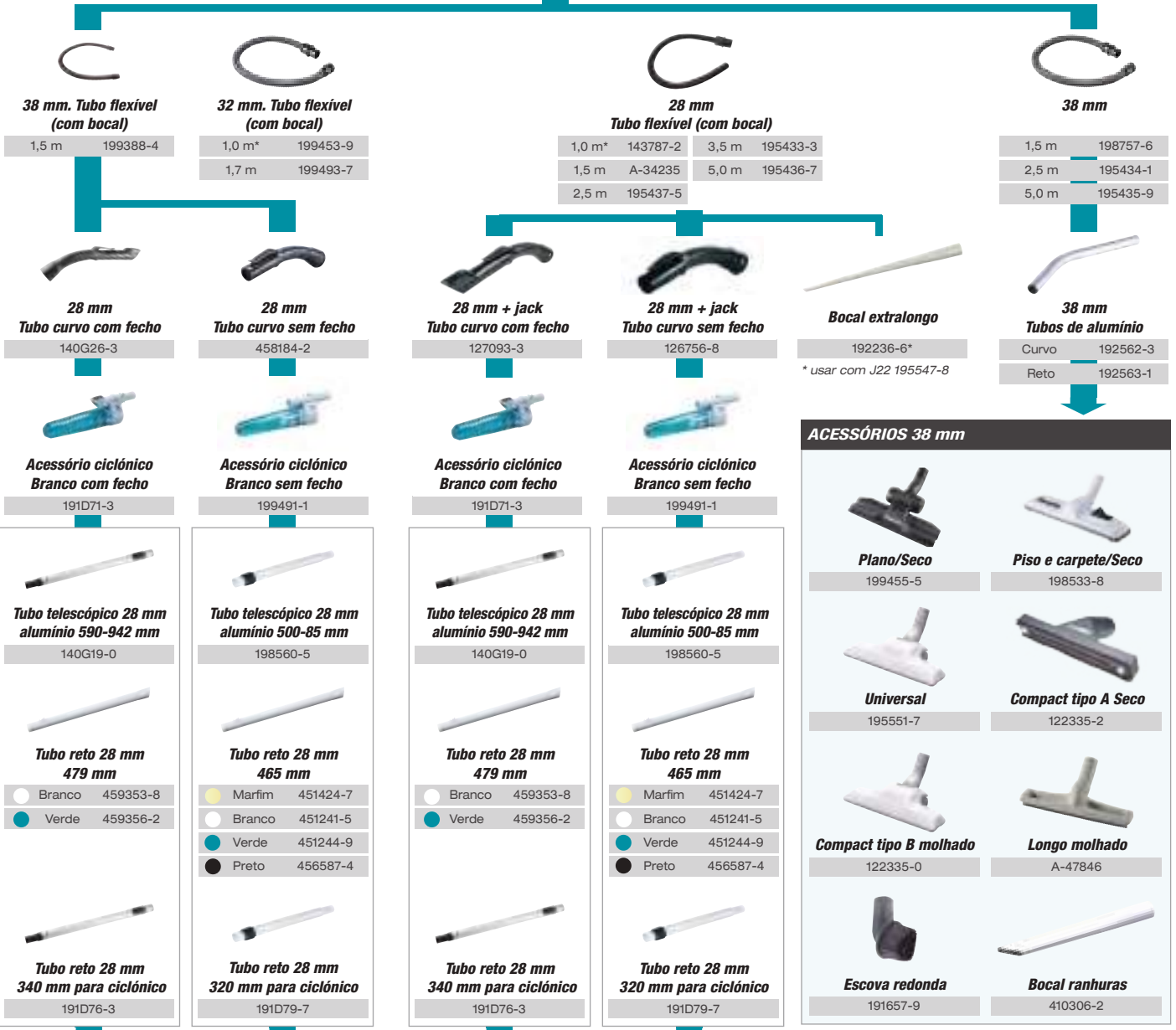



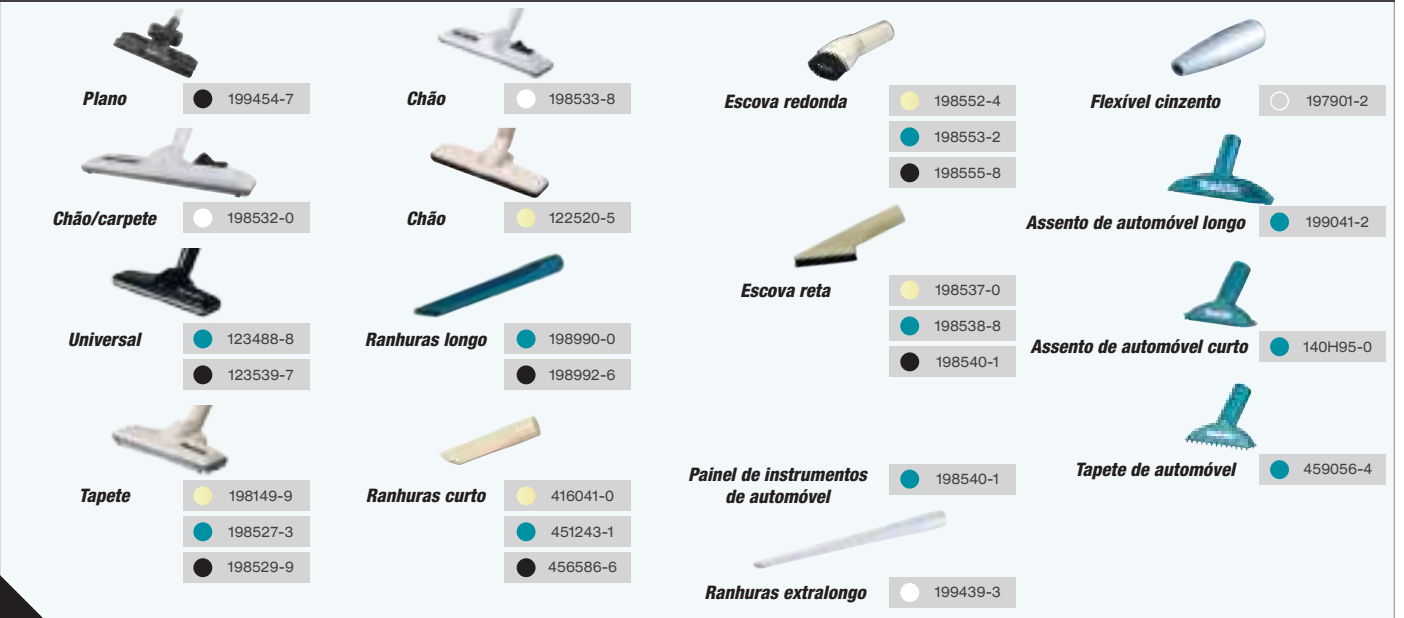











DVC660
DVC665





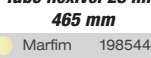













ACESSÓRIOS 28 mm (seco)



Acessórios para aspiradores

<p>DVC750L</p> 	<p>DCL281F</p> 	<p>DCL180 DCL180ZB CL180FD CL106D</p> 	<p>DCL184 CL121D</p> 
<p>Adaptador 418500-0</p> 	<p>Acessório ciclónico Branco com fecho 191D71-3</p> 	<p>Acessório ciclónico Branco sem fecho 199491-1</p> 	<p>Bocal de sopro completo 140J64-3</p> 
<p>Tubo telescópico 28 mm alumínio 500-85 mm 198560-5</p> 	<p>Tubo telescópico 28 mm alumínio 590-942 mm 140G19-0</p> 	<p>Tubo telescópico 28 mm alumínio 500-85 mm 198560-5</p> 	<p>Tubo flexível 28 mm 465 mm 198544-3</p> 
<p>Tubo reto 28 mm 465 mm Marfim 451424-7 Branco 451241-5 Verde 451244-9 Preto 456587-4</p> 	<p>Tubo reto 28 mm 479 mm Branco 459353-8 Verde 459356-2</p> 	<p>Tubo reto 28 mm 465 mm Marfim 451424-7 Branco 451241-5 Verde 451424-7 Preto 451241-5</p> 	<p>Tubo flexível 28 mm 465 mm Marfim 198544-3 Verde 198545-1 Preto 198547-7</p> 
<p>Tubo reto 28 mm 320 mm para ciclónico 191D79-7</p> 	<p>Tubo reto 28 mm 340 mm para ciclónico 191D76-3</p> 	<p>Tubo reto 28 mm 320 mm para ciclónico 191D79-7</p> 	

ACESSÓRIOS 28 mm (seco)

<p>Plano ● 199454-7</p> 	<p>Chão ○ 198533-8</p> 	<p>Escova redonda ● 198552-4 ● 198553-2 ● 198555-8</p> 	<p>Flexível cinzento ○ 197901-2</p> 
<p>Chão/carpete ○ 198532-0</p> 	<p>Chão ● 122520-5</p> 	<p>Escova reta ● 198537-0 ● 198538-8 ● 198540-1</p> 	<p>Assento de automóvel longo ● 199041-2</p> 
<p>Universal ● 123488-8 ● 123539-7</p> 	<p>Ranuras longo ● 198990-0 ● 198992-6</p> 	<p>Painel de instrumentos de automóvel ● 198540-1</p> 	<p>Assento de automóvel curto ● 140H95-0</p> 
<p>Tapete ● 198149-9 ● 198527-3 ● 198529-9</p> 	<p>Ranuras curto ● 416041-0 ● 451243-1 ● 456586-6</p> 	<p>Ranuras extralongo ○ 199439-3</p> 	<p>Tapete de automóvel ● 459056-4</p> 

***JOGO COMPLETO**

195439-1

Tubo flexível 38 mm x 2,5 m
Tubo reto e curvo
Pé de aspiração
Bocal para ranhuras



SUPORTE

199971-7

Indicado para
DCL281F
DCL180
DCL180ZB



Acessórios para aspiradores

VC3012L
VC4210L



VC2012L
VC2512L
VC3011L



**32 mm.
Tubo flexível**

P-84084



Tubo curvo inox

P-70346



**Tubos retos
35 x 500 mm (2 un.)**

P-70437



**Tubos retos
35 x 350 mm (3 un.)**

W107418350



**32 mm.
Tubo flexível**

3,5 m P-81739



Tubo curvo

P-72908



**Tubos retos
35 x 520 mm (2 un.)**

P-72942

ACESSÓRIOS 32 mm



**Bocal para ranhuras
5 x 300 mm**

W6084



**Pé seco/molhado
36 x 300 mm**

P-81789



Escova para carpete

P-70471



**Pé para carpete 275 mm
Seco/molhado**

P-70465



**Pé extralongo
405 mm Seco/molhado**

P-72964



**Pé longo
350 mm Seco/molhado**

P-72958



Bocal flexível

W5067

ACESSÓRIOS 32 mm



**Boca para ranhuras
35 x 200 mm**

W29541*



**Pé seco/molhado
36 x 260 mm**

W107402706



Escova para carpete

P-70471



**Pé para carpete 275 mm
Seco/molhado**

P-70465



**Pé extralongo
405 mm Seco/molhado**

P-72964



**Pé longo
350 mm Seco/molhado**

P-72958



Bocal flexível

W5067

Kit de aspiração completo



Descrição	Código	EAN	P.V.P. (€)
JOGO Makita - Tubo ø 36 x 4000 mm. - Tubo curvo cromado. - 2 x tubo reto de 500 mm cromado. - Pé de 350 mm para a limpeza de pisos.	P-70328	0088381700887	108,00
Ligação dupla	W15331	-	31,00
Bocal rotativo para tubo de 36 mm	P-70390	0088381700955	14,95
Bocal rotativo para tubo de 27 mm	P-70409	0088381700962	14,40



Lista de códigos e preços - Acessórios para aspiradores

Código	EAN	P.V.P. (€)
122335-0	0088381126878	14,40
122335-2	-	*
122520-5	0088381141260	8,25
123488-8	0088381589765	10,30
123539-7	-	10,30
126756-8	0088381548403	8,45
127093-3	0088381541619	10,80
140G19-0	0088381541626	20,70
140G26-3	0088381584180	9,20
140H95-0	0088381544887	5,15
140J64-3	0088381544924	7,60
143787-2	0088381485838	30,00
191657-9	0088381142892	14,40
191D71-3	0088381556637	39,00
191D76-3	0088381556668	5,95
191D79-7	0088381556699	4,35
192236-6	0088381117746	5,65
192562-3	0088381141116	9,10
192563-1	0088381141123	8,65
195433-3	0088381370264	59,00
195434-1	0088381370271	59,00
195435-9	0088381370288	109,00
195436-7	0088381370295	72,00
195437-5	0088381370301	47,00
195439-1	0088381370493	100,00
195551-7	0088381370394	27,00
197901-2	0088381468084	6,55
198149-9	0088381475020	14,40
198527-3	0088381484299	14,40
198529-9	0088381484312	14,40
198532-0	0088381484329	23,00
198533-8	0088381484336	24,00

Código	EAN	P.V.P. (€)
198537-0	088381484374	7,20
198538-8	0088381484381	5,40
198540-1	0088381484404	5,40
198544-3	0088381484442	8,25
198545-1	0088381484459	8,25
198547-7	0088381484473	8,25
198552-4	0088381484527	5,40
198553-2	0088381484534	5,40
198555-8	088381484558	5,40
198559-0	0088381484572	18,75
198560-5	0088381484589	23,00
198990-0	0088381519335	2,20
198992-6	0088381519359	2,20
199041-2	0088381524995	7,20
199388-4	0088381533874	59,00
199439-3	0088381537162	3,80
199453-9	0088381539043	16,45
199454-7	0088381539685	29,00
199455-5	0088381539692	29,00
199491-1	0088381536905	36,00
199493-7	0088381539142	18,65
199971-7	0088381546171	5,25
191M50-5	0088381571982	54,00
410306-2	0088381123709	3,40
416041-0	0088381141284	1,30
451241-5	0088381362733	2,15
451243-1	0088381453769	0,80
451244-9	-	4,05
451424-7	0088381366847	2,20
456586-6	-	1,10
456587-4	-	1,95
458184-2	0088381536028	*

Código	EAN	P.V.P. (€)
459056-4	0088381544894	2,50
459353-8	-	2,30
459356-2	0088381556897	2,30
A-34235	0088381163293	35,00
A-47846	0088381313360	32,00
P-70346	0088381700900	30,00
P-70437	0088381700993	35,00
P-70465	0088381701020	31,00
P-70471	0088381701037	10,05
P-72942	0088381703604	28,00
P-72964	0088381703628	60,00
P-81745	0088381457569	21,00
P-81789	0088381457385	26,00
P-84084	0088381483896	65,00
P-72908	0088381703567	24,00
P-72958	0088381703611	48,00
P-72964	0088381703628	60,00
P-81739	0088381457552	36,00
P-81745	0088381457569	21,00
P-81789	0088381457385	26,00
P-84084	0088381483896	65,00
W107402706	-	14,40
W107418350	0088381490122	33,00
W29541	-	4,40
W5067	3240890251527	13,15
W6084	0088381431095	5,15



* Consultar P.V.P.

Filtros para aspiradores

	Suporte do filtro	Filtro	Espuma do filtro	Pré-filtro
DVC860L DVC862L DVC150L DVC155L	-	-	-	
	-	-	-	140248-3
DVC864L DVC154L DVC157L	-			
	-	197166-6	423398-2	140253-0
DVC260 DVC261 DVC265	-		-	-
	-	127725-2	-	-
DVC660 DVC665	-		-	-
	-	191D12-9	-	-
DVC750L	-			
	-	162518-0	422449-8	162635-6
DCL281F			-	
	458467-0	198915-4	-	198751-8
DCL180Z DCL180ZB CL108FD CL106FD			-	
	458467-0	443060-3	-	451208-3
DCL184 CL121D	-	-		-
	-	-	422440-6	-
DRC200	-		-	-
	-	SH00000213	-	-
VC4210L	-		-	-
	-	W107413540	-	-
DVC560	-		-	-
	-	191E39-5	-	-
VC2012L VC2512L VC3011L VC3012L	-		-	-
	-	P-70219	-	-

Descrição	Un.	Código	EAN	P.V.P. (€)	
Filtro	1	127725-2	0088381575621	9,00	R
Pré-filtro	1	140248-3	0088381469999	14,75	R
Pré-filtro	1	140253-0	-	18,50	
Filtro	1	162518-0	0088381547864	18,00	R
Pré-filtro	1	162635-6	-	9,80	
Filtro	1	191D12-9	0088381557719	11,00	R
Filtro	1	197166-6	0088381449953	59,00	R
Pré-filtro	1	198751-8	0088381490450	4,10	
Filtro	1	198915-4	0088381497497	7,00	R
Espuma do filtro	1	422440-6	-	0,50	R
Espuma do filtro	1	422449-8	-	2,75	
Espuma do filtro	1	423398-2	0088381536196	9,25	
Filtro	1	443060-3	0088381123853	1,00	R
Pré-filtro	1	451208-3	0088381359993	1,80	
Suporte do filtro	1	458467-0	-	0,50	R
Filtro	1	P-70219	0088381700771	36,00	R
Filtro	1	SH00000213	0088381479189	80,00	R
Filtro	1	W107413540	-	71,00	
Filtro HEPA	1	191E39-5	0088381565431	10,90	

Pré-filtro DCL281



Descrição	Un.	Código	EAN	P.V.P. (€)
Pré-filtro	1	199966-0	0088381546515	6,75



Sacos para aspiradores

	Saco de papel	Saco de plástico	Saco de nylon	Saco reutilizável
DVC860L DVC862L DVC150L DVC155L	-	-		-
	-	195432-5	195557-5	-
DVC864L DVC154L DVC157L	-			-
	-	195432-5	195557-5	-
DVC260 DVC261 DVC265	-	-		
	-	-	197903-8	197899-3
DVC660 DVC665	-	-		
	-	-	191C26-2	191C30-1
CL106FD CL108FD DCL180Z DCL180ZB DCL184		-	-	-
	194566-1	-	-	-
VC4210L				-
	P-70203	W107418355	W107418353	-
VC3011L VC3012L				-
	P-70194	P-70306	P-72899	-
VC2012L VC2512L VC3011L	-			-
	-	P-70297	P-78293	-

Descrição	Un.	Código	EAN	P.V.P. (€)
Saco de nylon	10	191C26-2	-	21,05
Saco reutilizável	1	191C30-1	-	18,60
Saco de papel	5	194566-1	0088381351270	3,75
Saco de plástico	10	195432-5	-	7,05
Saco de nylon	5	195557-5	0088381370479	25,00
Saco reutilizável	1	197899-3	0088381468060	26,00
Saco de nylon	10	197903-8	0088381468107	29,00
Saco de papel	5	P-70194	0088381700757	32,00
Saco de papel	5	P-70203	0088381700764	61,00
Saco de plástico	5	P-70297	0088381700856	28,00
Saco de plástico	5	P-70306	0088381700863	63,00
Saco de tecido	5	P-72899	0088381703550	26,00
Saco de nylon	5	P-78293	0088381709040	35,00
Saco de papel	5	W107418353	0088381490153	36,00
Saco de plástico	5	W107418355	0088381490177	33,00
Saco de nylon	10	191D63-2	0088381565424	18,55

Adaptador AWS















- O adaptador sem fios Bluetooth WUT02 permite ligar e desligar sem fios os aspiradores Makita. Inclui dispositivo AWS.



Descrição	Un.	Código	EAN	P.V.P. (€)
WUT02	1	199773-1	0088381542807	232,00



Conexões para aspiradores

 DVC260 DVC261 DVC265	 DVC660 DVC665 DVC150L DVC154L	 DVC155LZX2 DVC157LZX3	 DVC860L DVC862L DVC864L	 DVC750L	 VC3012L VC4210LX	 VC2012L VC2512L VC3011L
 28 mm x 1 m 143787-2 28 mm x 1,5 m A-34235 28 mm x 3,5 m 195433-3 28 mm x 5 m 195436-7	 38 mm x 1,5 m 198757-6 38 mm x 2,5 m 195434-1 38 mm x 5 m 195435-9	 32 mm x 4 m P-84084	 32 mm x 3,5 m P-81739			
 Ø 22 mm 195547-8 Ø 38 mm 195545-2 Ø 24 mm 195546-0	 Ø 24 mm 195546-0 Ø 22 mm 195548-6	 Ø 22 mm 195548-6 Ø 24 mm 195546-0 Ø 38 mm W107418688 Ø 24 mm P-70378 Ø 22 mm 192349-3	 Ø 38 mm P-70421 Ø 24 mm P-81745 Ø 22 mm 192349-3			

ACESSÓRIOS

Coletor de pó 230 mm  198440-5	Coletor de pó 125 mm  196845-3	Coletor de pó para discos de diamante  195386-6	Extrator de pó para martelos leves  *HR2230/HR2460/HR2470 193472-7	Kit de vá aspiração para multifunções  *DTM51 196765-1	Adaptadores de aspiração  *RP1800X/RP2300FCX 194934-8
Coletor de pó para martelos combinados  195866-2	para demolidores  197168-2	Adaptador de serras tico-tico  417853-4	Adaptador para serras circulares  415816-4	Coletor de pó  *3706/DCO180 193449-2	

Descrição	Un.	Código	EAN	P.V.P. (€)	Descrição	Un.	Código	EAN	P.V.P. (€)	Descrição	Un.	Código	EAN	P.V.P. (€)
	1	195547-8	0088381370349	3,15		1	P-70378	0088381700931	23,00		1	P-72936	0088381703598	11,85
	1	195545-2	0088381370325	6,75		1	192349-3	0088381126229	7,70		1	192613-2	0088381140843	14,40
	1	195546-0	0088381370332	4,20		1	P-70421	0088381700986	19,05		1	P-19299	0088381945905	4,90
	1	195548-6	0088381370356	8,25		1	P-81745	0088381457569	21,00		1	191M78-3	0088381575782	9,30
	1	W107418688	0088381519946	28,00		1	P-70415	0088381700979	9,80		1	191M79-1	0088381575799	9,30

Conexões para aspiradores

ASPIRADORES

Ø 38 mm



Ø 24 mm



195546-0

Ø 22 mm



195548-6

Ø 28 mm



Ø 38 mm



195546-0

Ø 24 mm



195546-0

Ø 22 mm



195547-8

Ø 32 mm



Ø 24 mm



P-81745

Ø 24 mm



P-81745

J22



192349-3

Ø 32 mm



Ø 24 mm



P-70378

Ø 24 mm



P-70378

J22



192349-3

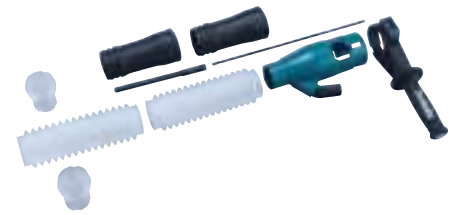

Adaptador

Ø 24 mm

Modelos	Un.	Código	EAN	P.V.P. (€)
HR4001C HR4011C HR4501C HR4511C	1	196074-8	0088381407632	105,00
HR4003C HR4013C	1	199142-6	0088381524339	100,00
HR5212C	1	196858-4	0088381441599	77,00
DHR400	1	199142-6	0088381524339	100,00

Sem adaptador

Tubo de 28 mm

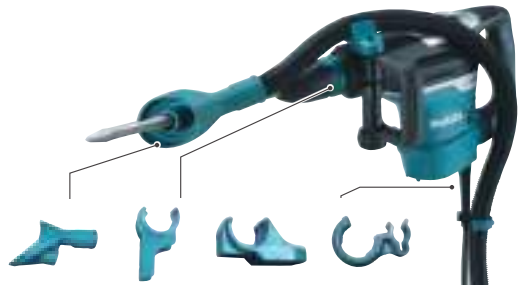

Modelos	Un.	Código	EAN	P.V.P. (€)
HM1307C HM1317C HM1400 HM1812	1	197168-2	0088381449984	53,00

Adaptador

Ø 22 mm



Modelos	Un.	Código	EAN	P.V.P. (€)
DHR242 DHR264 DHR280 DHR282 HR2630 HR2600 HR2300	1	195173-3	0088381361125	7,05
DHR243 DHR281 DHR283 HR2611FT HR2610T HR2631FT HR2630T	1	195179-1	0088381361194	8,40

Adaptador

Ø 22 mm



Modelos	Un.	Código	EAN	P.V.P. (€)
HR2230 HR2460 HR2470	1	193472-7	0088381174022	46,00

Conexões para aspiradores

REBARBADORAS

Modelo + acessório

Mini rebarbadoras
115/125 mm



Coletores
de pó



196845-3

Mini rebarbadoras
180/230 mm



198440-5**



** Inclui bocal 192613-2 no equipamento básico do acessório.

Mini rebarbadoras
115/125 mm



Coletor de pó
para
discos de
diamante



195239-9

Mini rebarbadoras
180/230 mm



195385-8



Aspirador + acessório

Ø 38 mm



DVC860L
DVC861L
DVC864L
DVC750L

DVC150L
DVC151L
DVC157L

Não requer adaptador

Ø 28 mm



DVC261
DVC265
DVC660
DVC665

Ø 38 mm



195545-2

Ø 32 mm



VC2012L
VC2512L
VC3011L

Ø 38 mm



P-70421

Ø 32 mm



VC3012L
VC4210L

Ø 38 mm



W107418688

Ø 38 mm



















Ø 38 mm



















Ø 38 mm

Ø 38 mm

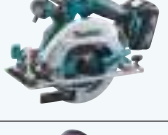
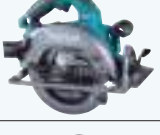
Conexões para aspiradores

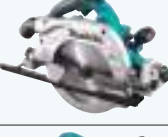
PLAINAS E SERRAS TICO-TICO

























Modelo + acessório		Aspirador + acessório
<p>DKP180 KP0800</p>   <p>451329-1</p>	<p>Ø 38 mm</p>	<p>Ø 38 mm</p>  <p>DVC860L DVC861L DVC864L DVC750L</p> <p>DVC150L DVC151L DVC157L</p>
<p>DKP181 KP0810/C</p> 	<p>Ø 38 mm</p>	<p>Ø 22 mm</p>  <p>195548-6</p>
		<p>Ø 28 mm</p>  <p>DVC261 DVC265 DVC660 DVC665</p>
<p>4326 4327 4328 4329 JV100D JV0600</p> 	<p>Ø 22 mm</p>	<p>Ø 38 mm Ø 22 mm</p>  <p>195545-2 195547-8</p>
<p>4350T 4350CT 4350FCT 4351T 4351CT 4351FCT</p>   <p>417853-4</p>	<p>Ø 22 mm</p>	<p>Ø 32 mm</p>  <p>VC2012L VC2512L VC3011L</p>
<p>DJV180 DJV181 DJV182</p>   <p>417853-4</p>	<p>Ø 22 mm</p>	<p>Ø 38 mm Ø 24 mm J22</p>  <p>P-70421 P-81745 192349-3</p>
		<p>Ø 32 mm</p>  <p>VC3012L VC4210LX</p> <p>Ø 38 mm Ø 24 mm J22</p>  <p>W107418688 P-70378 192349-3</p>

Modelo + acessório		Aspirador + acessório										
5903R 5903RK 5103R			192419-8*	Ø 38 mm		Ø 38 mm	DVC860L DVC861L DVC864L DVC750L	DVC150L DVC151L DVC157L				
5604R 5017RKB				Ø 38 mm								
5008MG			450079-5*	Ø 38 mm		Ø 24 mm	195546-0					
5603RK 5704R 5705RK			192420-3*	Ø 38 mm								
5143R			415816-4*	Ø 38 mm								
DHS660 DHS661				Ø 24 mm		Ø 38 mm	195545-2	Ø 24 mm	+	Ø 38 mm	195546-0	195545-2
DHS680				Ø 24 mm								
DHS710 HS003G HS004G HS6601 HS7601			196520-1*	Ø 24 mm								
DHS900				Ø 24 mm								
DSP6000 DSP601 SP6000				Ø 24 mm								
HS009G				Ø 24 mm								
												

* Incluído no equipamento básico.

Conexões para aspiradores

























SERRA DE ESQUADRIA/MULTIFUNÇÕES









Modelo + acessório		Aspirador + acessório				
<p>DLS111ZU DLS211ZU LS002G LS003G LS004G</p> 	<p>Ø 24 mm</p>		<p>Ø 38 mm</p>  <p>DVC860L DVC861L DVC864L DVC750L</p> <p>DVC150L DVC151L DVC157L</p>			
<p>DLS600 DLS714</p> 	<p>Ø 38 mm</p>		<p>Ø 24 mm</p>  <p>195546-0</p>	<p>Ø 22 mm</p>  <p>195548-6</p>		
<p>LH1040F LH1201FL LS0815FLN LS1018LN</p> 	<p>Ø 38 mm</p>		<p>Ø 28 mm</p>  <p>DVC261 DVC265</p> <p>DVC660 DVC665</p>			
<p>LS1019L</p> 	<p>Ø 38 mm</p>		<p>Ø 22 mm</p>  <p>195547-8</p>	<p>Ø 24 mm</p>  <p>195546-0</p>	<p>Ø 38 mm</p>  <p>195545-2</p>	<p>Ø 38 mm</p>  <p>195545-2</p>
<p>LS1040FN</p> 	<p>Ø 38 mm</p>		<p>Ø 32 mm</p>  <p>VC2012L VC2512L VC3011L</p>			
<p>LS1219L</p> 	<p>Ø 38 mm</p>		<p>Ø 38 mm</p>  <p>P-70421</p>	<p>Ø 24 mm</p>  <p>P-81745</p>		
<p>BTM50 DTM51 TM30D</p> 	<p>Ø 22 mm</p>  <p>199627-2</p>	<p>Ø 32 mm</p>  <p>VC3012L VC4210LX</p>				
<p>TM3000 TM3010</p> 	<p>Ø 22 mm</p>  <p>199624-8</p>	<p>Ø 38 mm</p>  <p>W107418688</p>	<p>Ø 24 mm</p>  <p>P-70378</p>			

Não é possível conectar multifunções a VC3012L e VC4210Lx

Conexões para aspiradores

FRESADORAS + TUPIAS

Modelo + acessório		Aspirador + acessório	
<p>DCO180 DCO181</p> 	 193449-2	<p>Ø 22 mm</p>	
<p>DRT50 RT0700C RT0702C</p> 	 195559-1	<p>Ø 38 mm</p>	
<p>RPO900</p> 	 194733-8	<p>Ø 38 mm</p>	
<p>RP110C</p> 	 122615-4	<p>Ø 22 mm</p>	
<p>RP1800X RP2300FC</p> 	 194934-8	<p>Ø 38 mm</p>	
			
			<p>Ø 38 mm</p>  <p> DVC860L DVC861L DVC864L DVC750L </p> <p> DVC150L DVC151L DVC157L </p>
			<p>Ø 22 mm</p>  <p>195548-6</p>
			<p>Ø 28 mm</p>  <p> DVC261 DVC265 DVC660 DVC665 </p>
			<p>Ø 38 mm</p>  <p>195545-2</p>
			<p>Ø 22 mm</p>  <p>195547-8</p>
			<p>Ø 32 mm</p>  <p> VC2012L VC2512L VC3011L </p>
			<p>Ø 38 mm</p>  <p>P-70421</p>
			<p>Ø 24 mm</p> 
			<p>J22</p>  <p>192349-3</p>
			<p>Ø 32 mm</p>  <p> VC3012L VC4210LX </p>
			<p>Ø 38 mm</p>  <p>W107418688</p>
			<p>Ø 24 mm</p> 
			<p>J22</p>  <p>192349-3</p>

Modelo + acessório		
9032		Ø 22 mm 122652-8
9031 9046		Ø 22 mm
9404 9902 9903 9910 9911 9920		Ø 22 mm
9403 9921		Ø 22 mm
BO3711 BO4900 BO4901 BO4556 BO4565 BO4566		Ø 22 mm
BO5030 BO5031 BO5040 BO5041 BO6030 BO6040 DBO180 DBO380 DBO381		Ø 22 mm
BO6050		Ø 24 mm
DSL800		Ø 38 mm



Aspirador + acessório

Ø 38 mm			
			
DVC860L DVC861L DVC864L DVC750L		DVC150L DVC151L DVC157L	
Ø 24 mm	Ø 22 mm		
			
195546-0	195548-6		
Ø 28 mm			
			
DVC261 DVC265		DVC660 DVC665	
Ø 22 mm	Ø 24 mm	Ø 38 mm	Ø 38 mm
			
195547-8	195546-0	195545-2	195545-2
Ø 32 mm			
			
VC2012L VC2512L VC3011L			
Ø 38 mm	Ø 24 mm	Ø 24 mm	J22
			
P-70421	P-81745	P-81745	192349-3
Ø 32 mm			
			
VC3012L VC4210LX			
Ø 38 mm	Ø 24 mm	Ø 24 mm	J22
			
W107418688	P-70378	P-70378	192349-3

Acessórios para DRC200



Descrição	Un.	Código	EAN	P.V.P. (€)
Proteção de escova	1	SH00000314	-	40,00



Descrição	Un.	Código	EAN	P.V.P. (€)
Escova coletora	1	SH00000313	-	81,50



Descrição	Un.	Código	EAN	P.V.P. (€)
Fita de marcação 15 m	1	SH00000231	0088381475877	58,00



Descrição	Un.	Código	EAN	P.V.P. (€)
Escova lateral	2	SH00000065	0088381479158	45,00



Descrição	Un.	Código	EAN	P.V.P. (€)
Filtro de pó	1	SH00000213	0088381479189	80,00

Acessórios para sopradores

Jogo flexível



Modelo	Un.	Código	EAN	P.V.P. (€)
UB1103	1	196643-5	0088381437325	13,75

Bocais para UB1103



123245-4



123246-2

Descrição	Un.	Código	EAN	P.V.P. (€)
220 mm	1	123245-4	0088381451215	5,40
430 mm	1	123246-2	0088381437332	12,60

Saco coletor de pó.



Modelo	Un.	Código	EAN	P.V.P. (€)
UB1103	1	123241-2	0088381437103	8,10

Bocal para DUB182



Descrição	Un.	Código	EAN	P.V.P. (€)
220 mm	1	132025-7	0088381122856	3,85
430 mm	1	134182-7	0088381156998	10,40

Níveis de laser



Tripés



Tipo	Descrição	Rosca	Un.	Código	EAN	P.V.P. (€)
1	Tripé de alumínio 1,65 m máx.	5/8"	1	P-81088	0088381449564	84,00
2	Tripé de alumínio 2,70 m máx.	5/8"	1	P-81315	0088381451291	251,00
3	Tripé 1,58 m máx.	1/4"	1	B-8539	3240890901187	49,00
4	Tripé 1800 para SK209	1/4"	1	TK0LM4001F	0088381442374	141,00
5	Tripé 2900 para SK209	1/4"	1	TK0LM5030F	0088381442381	204,00
6	Tripé de alumínio 1,15 m máx. SK700D	1/4"	1	LE00874658	088381539876	103,00



Recetores



TK0LDG301G



LE00796587



LE00784968



LE00796588



LE00837085



LE00837096



LE00855702

Descrição	Un.	Modelo	Código	EAN	P.V.P. (€)
Recetor (inclui suporte)	1	SK209	TK0LDG301G	0088381488853	321,00

Recetor (inclui suporte) LR150	1	SKR200	LE00796587	3240890394156	330,00
Suporte do recetor	1	SKR200	LE00784968	3240890394200	66,00
Comando à distância SKR200	1	SKR200	LE00796588	3240890394163	61,00

Recetor Funciona como comando	1	SK104Z SK103PZ	LE00837085	0088381488877	167,00
Suporte do recetor	1	SK700D	LE00837096	-	50,00

Recetor Inclui suporte	1	SK700D SK700GD	LE00855702	0088381535366	221,00
------------------------	---	----------------	------------	---------------	--------

Suportes

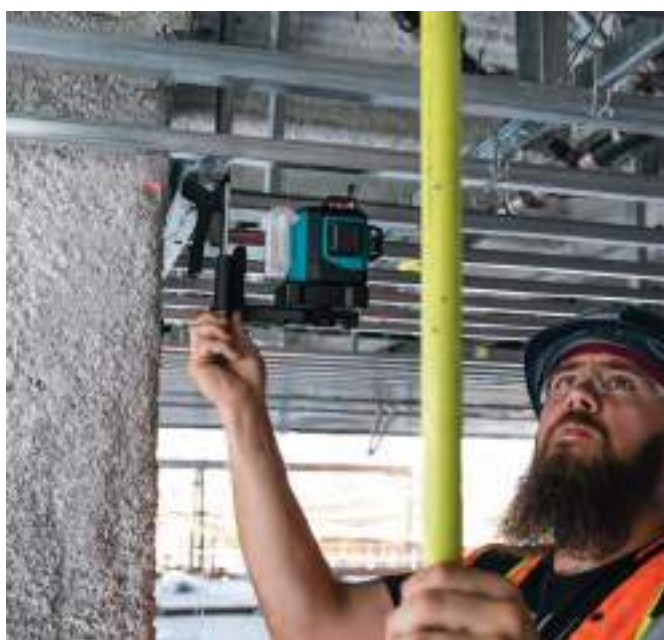

	Descrição	Modelo	Un.	Código	EAN	P.V.P. (€)
1	Suporte de parede	SK105D SK105DG SK106D SK106DG SK700D SK700GD	1	LE00929104	3240890328847	122,00
2	Suporte de parede	SK105D SK105DG SK106D SK106DG SK700D SK700GD	1	LE00929104	-	78,00
3	Suporte de parede simples	SK105D SK105DG SK106D SK106DG, SK102 SK103P SK104	1	LE00870131	0088381528726	31,00
4	Suporte de parede magnético	SK105D SK105DG SK106D SK106DG SK102 SK103P SK104	1	LE00870134	0088381528733	43,00
5	Suporte de parede	SK105D SK105DG SK106D SK106DG SK102 SK103P SK104	1	LE00870137	0088381528757	72,00
6	Suporte magnético	SK104Z SK103PZ	1	LE00785633	3240890347763	14,40
7	Suporte magnético	SK104Z SK103PZ	1	LE00789389	0088381488860	42,00
8	Suporte de parede	SKR200Z	1	LE00791661	3240890394170	97,00

Escala de alumínio



Comprimento	Unidades	Código	EAN	P.V.P. (€)
1,2 - 4,0 m	1	P-81309	0088381451178	72,00

Cartões magnéticos



Descrição	Un.	Código	EAN	P.V.P. (€)
Cartão magnético vermelho	1	LE00785638	3240890328830	16,75
Cartão magnético verde	1	LE00823195	-	23,00

Sacos de transporte



LE00864505

Descrição	Modelo	Un.	Código	EAN	P.V.P. (€)
Saco alto	SK104Z SK103PZ	1	LE00822220	-	29,00
Saco alto	SK105D SK105GD SK106D SK106GD	1	LE00864505	-	36,00
Saco alto	SK700D SK700GD	1	LE00929103	-	43,00

Óculos para melhorar a visão a laser



Descrição	Un.	Código	EAN	P.V.P. (€)
Óculos para laser vermelhos (1)	1	LE00834534	-	18,55
Óculos para laser verdes (2)	1	LE00772796	-	24,00
Óculos para laser verdes (1)	1	TK02100200	-	18,55

Cabos USB



Permite usar uma bateria LXT de 18 V quando usado com o adaptador para USB ADP05 (vendido em separado).

Descrição	Modelo	Un.	Código	EAN	P.V.P. (€)
Cabo USB	SK209	1	199010-3	88381519663	12,90
Cabo USB	SK105 SK106	1	199178-5	0088381528238	10,30



Roedoras, tesouras e puncciónadora



Capacidade em corte circular JN1601 e JN3201

D	21 mm	JN1601
e	5 mm	
R	50 mm	
D	42 mm	JN3201
e	8 mm	
R	128 mm	

JS8000



Descrição	Un.	Código	EAN	P.V.P (€)
Cabeça completa	1	125354-5	3240890285218	116,00
Lâmina central	1	725129-8	0088381341455	68,00
Lâmina lateral	1	725130-3	0088381341448	58,00

Punções



Modelo	Un.	Código	EAN	P.V.P (€)
JN1601 DJN161	1	A-83951	0088381146630	26,00
JN3200 JN3201	1	792728-1	0088381103602	27,00

Lâmina central



Modelo	Un.	Código	EAN	P.V.P (€)
JS1601	1	792534-4	0088381105477	59,00
JS1000	1	792537-8	0088381105484	76,00

Jogo de lâminas



Modelo	Un.	Código	EAN	P.V.P (€)
JS1602	1	191383-0	008838111874	29,00
JS1601	1	792533-6	0088381105453	45,00
JS1000	1	792536-0	0088381105460	45,00
JS3200 JS3201	1	792287-5	0088381103589	32,00

Matrizes



Modelo	Un.	Código	EAN	P.V.P (€)
JN1601 DJN161	1	A-15051	0088381130219	22,00
JN3200 JN3201	1	792292-2	0088381103619	26,00

Jogo Calibrador de folgas



Modelo	Un.	Código	EAN	P.V.P (€)
JS1601	1	762013-6	0088381102162	3,85
JS3200 JS3201	1	762007-1	0088381102155	4,35

Chaves allen

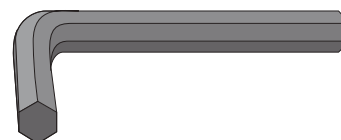

Modelo	Un.	Código	EAN	P.V.P (€)
JS1601 JS1602 JS1000 JN3201	1	783201-2	0088381101288	1,05
JN1601	1	783208-8	0088381152624	1,05
JS3200 JS3201	1	783202-0	0088381102667	1,05

Chaves para roedoras



Modelo	Un.	Código	EAN	P.V.P (€)
JN1601	1	781028-4	0088381152600	3,00
JN3200 JN3201	1	781019-5	0088381102452	3,10

Anilha Complementar

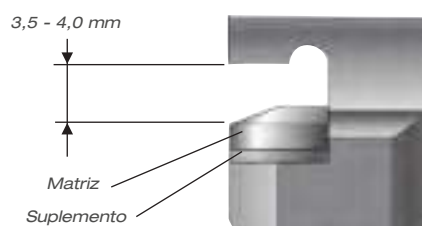

Modelo	Un.	Código	EAN	P.V.P (€)
JN3200 JN3201	1	341796-7	0088381155298	1,05



Acessórios para DPP200

Base



Descrição	Un.	Código	EAN	P.V.P (€)
Base	1	SC03801080	-	88,00

Batente deslizante



Descrição (mm)	Un.	Código	EAN	P.V.P (€)
Batente deslizante	1	SC03300790	-	80,00

Acessórios para DPP200

Punções redondas



Descrição (mm)	Un.	Código	EAN	P.V.P (€)
Punção 6	1	SC05340040	-	108,00
Punção 6,5	1	SC05340050	-	108,00
Punção 8	1	SC05340060	-	108,00
Punção 8,5	1	SC05340070	-	108,00
Punção 10	1	SC05340080	-	108,00
Punção 11	1	SC05340090	-	108,00
Punção 12	1	SC05340100	-	108,00
Punção 13	1	SC05340110	-	108,00
Punção 14	1	SC05340120	-	108,00
Punção 15	1	SC05340130	-	108,00
Punção 16	1	SC05340140	-	108,00
Punção 18	1	SC05340150	-	108,00
Punção 20	1	SC05340160	-	108,00

Batentes redondos



Descrição (mm)	Un.	Código	EAN	P.V.P (€)
Batente redondo SB-6	1	SC00000203	-	108,00
Batente redondo SB-6,5	1	SC00000205	-	108,00
Batente redondo SB-8,5	1	SC00000207	-	108,00
Batente redondo SB-8,5	1	SC00000209	-	108,00
Batente redondo SB-10	1	SC00000211	-	108,00
Batente redondo SB-11	1	SC00000213	-	108,00
Batente redondo SB-12	1	SC00000215	-	108,00
Batente redondo SB-13	1	SC00000217	-	108,00
Batente redondo SB-14	1	SC00000219	-	108,00
Batente redondo SB-15	1	SC00000221	-	108,00
Batente redondo SB-16	1	SC05332710	-	108,00
Batente redondo SB-18	1	SC00000223	-	108,00
Batente redondo SB-20	1	SC05352510	-	108,00

Punções Ovais



Descrição (mm)	Un.	Código	EAN	P.V.P (€)
Punção 6,5 x 10	1	SC05340200	-	149,00
Punção 6,5 x 13	1	SC05340210	-	149,00
Punção 8,5 x 13	1	SC05340220	-	149,00
Punção 8,5 x 17	1	SC05340230	-	149,00
Punção 9 x 13,5	1	SC05340240	-	149,00
Punção 9 x 18	1	SC05340250	-	149,00
Punção 10 x 15	1	SC05340260	-	149,00
Punção 10 x 20	1	SC05340270	-	149,00
Punção 11 x 16,5	1	SC05340280	-	149,00
Punção 12 x 18	1	SC05340290	-	149,00
Punção 13 x 19,5	1	SC05340300	-	149,00
Punção 14 x 21	1	SC05340310	-	149,00

Batentes de ovais



Descrição (mm)	Un.	Código	EAN	P.V.P (€)
Batente de estádio 6,5 x 10	1	SC00000244	-	108,00
Batente de estádio 6,5 x 13	1	SC00000246	-	108,00
Batente de estádio 8,5 x 13	1	SC00000248	-	108,00
Batente de estádio 8,5 x 17	1	SC00000250	-	108,00
Batente de estádio 9 x 13,5	1	SC00000252	-	108,00
Batente de estádio 9 x 18	1	SC00000254	-	108,00
Batente de estádio 10 x 15	1	SC00000256	-	108,00
Batente de estádio 10 x 20	1	SC00000258	-	108,00
Batente de estádio 11 x 16,5	1	SC00000260	-	108,00
Batente de estádio 12 x 18	1	SC00000262	-	108,00
Batente de estádio 13 x 19,5	1	SC00000264	-	108,00
Batente de estádio 14 x 21	1	SC00000266	-	108,00

Jardim



XGT
40V LI-ION
max

BREVEMENTE

Motosserra a bateria UC002

BL
MOTOR

Alta eficiência.

Motor BL sem escovas de rotor exterior com sistema de acionamento direto, que proporciona uma alta eficiência de potência.

Volume de trabalho

cerca de **160** cortes

- Madeira de cedro: 100 x 100 mm.
- Barra-guia de 350 mm.
- Serra de corrente 90PX.
- Bateria BL4040.



Peso **2,6** Kg

Velocidade da corrente

24,8 m/s

Anel em forma de "D"
 Ponto de fixação da corda.



Porca antiqueda
 para evitar perdas



Porca antiqueda
 para evitar perdas



Porca antiqueda
 para evitar perdas

Alta potência, comparável a uma motosserra de 30 c.c.

WG
WET GUARD
IPX4

Alta resistência à
água permite ao operador
trabalhar com a ferramenta
mesmo quando está molhada.



Excelente equilíbrio
Ferramenta muito equilibrada











Porca antiqueda
para evitar perdas



Porca antiqueda
para evitar perdas

Barras e correntes para motosserras

		BARRAS					CORRENTES				
		Características	Un.	Código	EAN	P.V.P. (€)	Características	Un.	Código	EAN	P.V.P. (€)
DUC122		11,5 cm 1/4"	1	158476-6	0088381354660	21,00	1/4" 25 AP 42 elos	1	791284-8	0088381141741	14,75
DUC254 DUC256		25 cm 3/8" b.p.	1	161846-0	0088381540216	14,40	3/8" b.p. 0,50	1	199075-5	0088381527767	12,95
DUC254C DUC256C		25 cm 1/4"	1	168395-8	0088381200097	55,00	1/4" 25 AP 60 elos	1	512466760	-	18,00
DUC252		25 cm (10") 3/8" - b.p.	1	168408-5	0088381197571	11,70	3/8" b.p. - 0,50 91 VG 40 elos	1	511492740	4002829806609	13,40
DUC306		30 cm (12") 3/8" - b.p.	1	165245-8	-	13,90	3/8" b.p. - 0,50 91 PX 46 elos	1	196740-7	-	18,55
DUC355		35 cm (14") 3/8" - b.p.	1	165441A8	-	22,00	3/8" b.p. - 0,50 91 VG 52 elos	1	511492752	4002829806883	13,65
UC4041A		40 cm (16") 3/8" - b.p.	1	165247-4	0088381358569	22,00	3/8" b.p. - 0,50 90SG 56 elos	1	511291756	4002829845172	14,15
UC3550A		35 cm (14") 3/8" - b.p.	1	165441A8	-	22,00	3/8" b.p. - 0,50 91 VG 52 elos	1	511492752	4002829806883	13,65
UC4050A ES2141KX		40 cm (16") 3/8" - b.p.	1	165247-4	0088381358569	22,00	3/8" b.p. - 0,50 91 VG 56 elos	1	511492756	4002829807125	14,15



Capas para lâmina-guia para motosserras

Capas para lâmina-guia					
Modelo	Características	Un.	Código	EAN	P.V.P. (€)
DUC122	Capas para lâmina-guia	-	199067-4 R	-	3,00
DUC254 DUC256		1	199067-4 R	-	3,00
DUC254C DUC256C		1	199067-4 R	-	3,00
DUC252		1	452093-7	-	1,90
DUC306		1	419288-5	-	*
DUC355		1	952010640	-	4,90
UC4041A		1	419242-9 R	-	2,80
UC3550A		1	952010640	4002829615454	4,90
UC4050A ES2141KX		1	952010640	4002829615454	4,90



* Consultar P.V.P.

Pá para ramagem



Modelo	Un.	Código	EAN	P.V.P. (€)
DUH523	1	195050-9	0088381358064	37,00
EH7500S	1	195321-4	0088381403375	22,00
UH201	1	198401-5	0088381483728	9,10
UH5570 UH5580 UH6570 UH6580	1	194681-1	0088381354349	23,00
UH004G UH006G	1	191R51-3	0088381583565	45,00
UH005G UH007G	1	191R52-1	0088381583572	73,00
DUN461	1	191T43-4	0088381583893	15,60
DUH754S UH014G	1	191D34-9	0088381559478	36,00

Sistema de anti-desconexão eléctrica



• Para todos os modelos eléctricos.

Para	Un.	Código	EAN	P.V.P. (€)
Motosserras	1	158024-1	0088381122955	1,60
Corta-sebes	1	194678-0	0088381352079	2,05

Calibrador de corrente



Descrição	Un.	Código	EAN	P.V.P. (€)
Calibrador	1	953100090	4002829111956	6,20

Chaves de velas



941713001

Jogo de calibração/afiação



Inclui	Un.	Código	EAN	P.V.P. (€)
Lima redonda 4 mm (x2), suporte, cabo (x2) e medidor de profundidade.	1	D-72154	0088381568340	23,00
Lima redonda 4,5 mm (x2), suporte, cabo (x2) e medidor de profundidade.	1	D-72160	0088381568357	23,00

Lima plana e cabo para lima



Cabo

Lima plana

Descrição	Un.	Código	EAN	P.V.P. (€)
Cabo para lima	1	953004010	4002829111727	2,30
Lima plana	1	953003060	4002829111659	6,45

Lima redonda



Ø da lima	Tipo de motosserra	Un.	Código	EAN	P.V.P. (€)
Cabo para lima		1	953004010	4002829111727	2,30
4,0 mm - 5/32"	91VG, 90SG	1	953003090	4002829111703	2,15
4,8 mm - 3/16"	95 VP, 21BP	1	953003070	4002829111666	2,15
5,2 mm - 3/64"	73LP, 73DP0	1	953003110	4002829477212	2,15
5,5 mm - 7/32"	73LP, 73DP	1	953003040	4002829111628	2,15

Conjunto porta-lima



Ø da lima	Tipo de motosserra	Un.	Código	EAN	P.V.P. (€)
4,0 mm - 5/32"	91VG, 90SG	1	953030010	4002829111871	14,95
4,8 mm - 3/16"	95 VP, 21BP	1	197712-5		7,45
5,5 mm - 7/32"	73LP, 73DP	1	953009000	4002829111857	13,90

Modelo	Ø (mm)	Un.	Código	EAN	P.V.P. (€)
DCS232T DCS232TC DCS3410TH	13/16 mm	1	941716132	4002829824498	2,85
Restantes modelos	13/19 mm	1	941719133	4002829824511	2,85
ELECTROSSER-RAS	13 mm	1	941713001	4002829172780	2,30

Sopradores

Bocais de saída



451753-8

183P98-9

183P97-1

455915-0

455634-8

197724-8

454896-5

166094-6

183P98-9

452123-4

191L96-5

191J13-3

Modelo	Detalhe	Un.	Código	EAN	P.V.P. (€)
BHX2501	Bocal plano	1	451753-8	0088381411332	4,10
DUB184	Bocal plano	1	183P98-9	0088381580373	10,85
	Extensão de bocal	1	183P97-1	0088381497152	10,60
	Tubo adaptador	1	191L14-3	-	6,20
	Bocal de saída largo	1	191B21-6	-	*
DUB362	Bocal plano	1	183P98-9	0088381580373	10,85
	Extensão de bocal	1	183P97-1	0088381497152	10,60
	Bocal de saída comprido	1	183R02-0	0088381585507	7,10
		1	191J13-3	0088381560887	9,70
DUB363	Bocal de saída comprido	1	166094-6	0088381494977	3,75
		1	127425-4	0088381576352	9,80
DUB361	Bocal de saída comprido	1	127501-4	-	8,25
		1	127502-2	0088381576369	16,90
		1	452123-4	0088381366373	12,35
UB001	Bocal plano	1	191L96-5	-	10,65
		1	183P98-9	0088381580373	10,85
EB7660TH	Bocal plano	1	166094-6	0088381494977	3,75
		1	455634-8	-	13,15
EB5300TH	Tubo reto 90 mm	1	197724-8	0088381472760	15,45
PB7650	Tubo cónico	1	454896-5	0088381453455	7,70

* consultar.

Kit de aspiração BHX2501



Modelo	Descrição	Un.	Código	EAN	P.V.P. (€)
BHX2501	kit de aspiração	1	197235-3	0088381474924	66,00

Acessório para limpeza de calçadas



Modelo	Descrição	Un.	Código	EAN	P.V.P. (€)
DUB362	Kit de aspiração	1	191B03-8	0088381560870	86,00

Kit de aspiração DUB363



Modelo	Descrição	Un.	Código	EAN	P.V.P. (€)
DUB363	Kit de aspiração	1	191E19-1	0088381558754	69,00

Motores multifunções
a bateria.

XGT

Uma ferramenta,
múltiplas aplicações...

LXT

Lítio-ion EXTREMA TECNOLOGIA

Agora também com bateria XGT

Acessórios para multifunções UX001G/DUX60/DUX18



Descrição	Un.	Código	EAN	P.V.P. (€)
Prolongador	1	191E27-2	0088381558600	118,00

Novo



Corte rotativo	1	191M75-9	-	464,00
Corte rotativo + barra	1	191M56-3	0088381572132	510,00



Descrição	Un.	Código	EAN	P.V.P. (€)
Motosserra	1	191T38-7	0088381581271	180,00



Corta-sebes de ângulo ajustável	1	196345-3	0088381424905	279,00
Corta-sebes para solo	1	198068-9	0088381473620	332,00
Corta-sebes reto	1	197750-7	0088381469258	228,00



Roçadora	1	195663-6	0088381376853	112,00
----------	---	----------	---------------	--------



Escova para varrer	1	199318-5	0088381533942	544,00
--------------------	---	----------	---------------	--------



Aparador	1	195566-4	0088381397650	84,00
----------	---	----------	---------------	-------



Cultivador	1	195717-9	0088381398060	268,00
------------	---	----------	---------------	--------

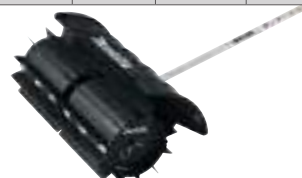

Rolo de neve	1	199339-7	0088381534130	570,00
--------------	---	----------	---------------	--------









Soprador	1	191P72-3	0088381580212	159,00
Bocal de saída	1	191C15-7	0088381558747	8,75

Roçadoras



Discos para roçadoras

Tipo	Modelo	Características	Un.	Código	EAN	P.V.P. (€)	
	EBH341U EM2600U EM2651UH EM4350UH EM4351UH	270 x 25,4	1	199874-5		38,00	
		255 x 25,4	1	195299-1	0088381364935	21,95	
		300 x 25,4	1	385224150	4002829752159	25,00	
		4 dentes	230 x 25,4	1	DA00000169		15,45
		4 dentes (reversível)	230 x 25,4	1	B-14118	0088381361064	11,35
		8 dentes	255 x 25,4	1	B-14124	0088381361071	11,85
			230 x 25,4	1	B-14130	0088381361088	11,85
		24 dentes	255 x 25,4	1	B-14146	0088381361095	13,40
			225 x 25,4	1	199872-9		25,00
		80 dentes	230 x 25,4	1	B-14152	0088381361101	13,40
	255 x 25,4		1	B-14168	0088381361118	14,95	

Adaptadores de cabeça

Tipo de cabeça	Descrição/Medida	Un.	Código	EAN	P.V.P. (€)
 Cabeça manual	Casquilho LH 8 x 1,25 Casquilho LH 10 x 1,00 Pino LM 8 x 1,25/0 x 1,25"	1	385224250	4002829760161	8,75
Cabeça T&G medium	Casquilho LH 8 x 1,25 Casquilho LH 10 x 1,00 Pino LM 8 x 1,25/10 x 1,25"	1	381224230	4002829760147	5,65
Cabeça T&G large	Casquilho LH 8 x 1,25 Casquilho LH 10 x 1,00 Casquilho LH 12 x 1,50 Casquilho LH 12 x 1,75 Pino LM 8 x 1,25/10 x 1,25"	1	382224310	4002829760154	7,70
Cabeça T&G Small	Casquilho LH 10x1,25	1	UA-1048	-	3,85

* É necessário usar um adaptador.



Tabela de compatibilidade de modelos

		Fixa	Manual	T&G small	T&G medium	T&G large
EM2600U	M10 x 1,25 LM	✓	✓	◇	✓	✓
EM2651UH	M10 x 1,25 LM	✓	✓	◇	✓	✓
EM3400U	M10 x 1,25 LM	✓	✓	◇	✓	✓
EM4350UH	M10 x 1,25 LM	✓	✓	◇	✓	✓
EM4351UH	M10 x 1,25 LM	✓	✓	◇	✓	✓
EBH341U	M10 x 1,25 LM	✓	✓	◇	✓	✓
BBC4500	M10 x 1,00 LM	✓	*	-	*	*
BBC5700	M10 x 1,00 LM	✓	*	-	*	*
DUR190	M10 x 1,25 LM	✓	✓	◇	✓	✓
DUR365	M10 x 1,25 LM	✓	✓	◇	✓	✓
DUR368	M10 x 1,25 LM	✓	✓	◇	✓	✓
DUR369	M10 x 1,25 LM	✓	✓	◇	✓	✓
DUX60	M10 x 1,25 LM	✓	✓	◇	✓	✓
UR101C	M10 x 1,25 LM	✓	✓	◇	✓	✓
UR201C	M10 x 1,25 LM	✓	✓	◇	✓	✓

- Incompatível. ✓ Compatível. * É necessário usar um adaptador. ◇ Válido com adaptador UA-1048.



Cabeças de nylon

- As cabeças Tap&Go são de carregamento fácil. Não é necessário desmontar a cabeça para carregar o fio.
- Cinco novas cabeças de nylon para cobrir as necessidades de todos os nossos modelos de roçadoras.
- Gama simplificada para facilitar a escolha dos nossos clientes.





Tipo de cabeça	Rosca	Capacidade	Recomendado	Descrição	Un.	Código	EAN	P.V.P. (€)	
	Cabeça de nylon	-	-	ET40	-	1	DA00000002	0088381374033	8,00
	Cabeça de nylon	-	6 m		Fio de nylon de corte redondo	1	195858-1	0088381400176	7,00
	Cabeça de nylon T&G	Rosca M8 x 125 LH	4 m	DUR181	Fio silencioso de 2,0 mm	1	191D92-5	0088381559300	17,50
	Cabeça de nylon T&G	Rosca M8 x 125 LH	4 m		Fio silencioso de 2,0 mm	1	191D91-7	0088381559294	17,50
	Cabeça de nylon	Rosca M8 x 125 LH	-	DUR182 DUR187 DUR189	Fio silencioso de 2,0 mm	1	123235-7	0088381498098	11,35
	Cabeça fixa	Universal	20 cm	-	Fio silencioso de 2,7 mm	1	384224270	4002829757741	23,00
	Cabeça manual	M10 x 1, 25 LH (esq.)	5m	Todos os modelos a bateria	Fio silencioso de 2,4 mm	1	385224240	4002829757734	17,25
	T&G small	Rosca M8 x 1,25 RH (dir.)	3,5 m	DUX60 (com adaptador UA-1048) Todos os modelos a bateria.	Fio silencioso de 2,0 mm	1	680224200	4002829757703	14,15
	T&G medium	M10 x 1, 25 LH (esq.)	4,5 m	EM2600U EM2651UH EM3400U EBH341U DUX60 Todos os modelos a bateria	Fio silencioso de 2,4 mm	1	381224240	4002829757710	17,25
	T&G large	M10 x 1, 25 LH (esq.)	4,5 m	EM4350UH EM4351UH BBC4500* BBC5700* Todos os modelos a bateria	Fio silencioso de 2,7 mm	1	382224300	4002829757727	19,55

Fios de nylon





Tipo	Descrição	Ø (mm)	Comprimento (m)	Un.	Código	EAN	P.V.P. (€)
Redondo	<ul style="list-style-type: none"> Fio de nylon redondo 1,65 x 15 metros. Especial para DUR181 	1,65	15	1	196148-5	0088381411523	4,85
Redondo	<ul style="list-style-type: none"> Concebido para o utilizador mais exigente no uso privado. Indicado para roçadoras de baixa cilindrada. 	2,4	5	1	B-01971	0088381120494	2,30
		3,0	4	1	B-07375	0088381349291	3,10
Round Trim	<ul style="list-style-type: none"> Concebido para o utilizador mais exigente no uso privado. Duas cores. Indicado para roçadoras de baixa cilindrada. O fio redondo oferece maior resistência ao ar e ao impacto. 	1,3	15	1	369224807	-	2,15
		1,6	15	1	369224808	-	2,45
		2,0	15	1	369224790	4002829756614	2,60
		2,0	126	1	369224791	4002829756621	10,80
Round Trim PLUS	<ul style="list-style-type: none"> Concebido para uso privado e semiprofissional. Aumentámos a resistência ao desgaste e o ponto de fusão. Indicado para máquinas de média cilindrada. 	2,4	15	1	369224792	4002829756638	3,35
			87	1	369224793	4002829756645	11,05
			262	1	369224794	4002829756652	29,00
		3,0	15	1	369224809	-	4,10
			56	1	369224811	-	11,05
			168	1	369224815	-	29,00
		3,3	15	1	369224810	-	4,65
			46	1	369224812	-	11,05
			139	1	369224816	-	29,00
Square Trim PLUS	<ul style="list-style-type: none"> Concebido para uso semiprofissional. Aumentámos a resistência ao desgaste e o ponto de fusão. Diminui a perda de rpm por atrito graças às suas arestas. Indicado para máquinas de média cilindrada. 	2,4	15	1	369224795	-	3,85
			69	1	369224796	-	11,05
			206	1	369224797	-	29,00
		3,0	15	1	369224819	-	4,90
			44	1	369224821	-	11,05
			132	1	369224825	-	29,00
		3,3	15	1	369224820	-	4,90
			36	1	369224822	-	11,05
			109	1	369224826	-	29,00
		3,5	32	1	369224823	-	11,05
			96	1	369224827	-	29,00
		4,0	25	1	369224824	-	11,05
75	1		369224828	-	29,00		
Round Trim PRO	<ul style="list-style-type: none"> Concebido para uso profissional. Elevada resistência ao calor. Para os trabalhos mais exigentes. Indicado para roçadoras de alta cilindrada. Combina duas camadas de material com diferentes níveis de dureza. 	3,0	15	1	369224798	4002829756669	4,90
			56	1	369224799	4002829756676	13,15
			168	1	369224800	-	33,00
			279	1	369224801	4002829756690	52,00
Square Trim PRO	<ul style="list-style-type: none"> Concebido para uso profissional. Elevada resistência ao calor. Para os trabalhos mais exigentes. Indicado para roçadoras de alta cilindrada. Diminui a perda de rpm por atrito graças às suas arestas. Combina duas camadas de material com diferentes níveis de dureza. 	3,0	15	1	369224802	-	5,40
			44	1	369224803	4002829756799	13,15
			132	1	369224804	-	34,00
			219	1	369224805	-	52,00

Fios de nylon silenciosos

Tipo	Descrição	Ø (mm)	Comprimento (m)	Un.	Código	EAN	P.V.P. (€)
Linha Quatro faces 	<ul style="list-style-type: none"> • Fio de nylon helicoidal. • Forma de quatro faces arredondadas que diminui o nível de ruído. • Graças à sua forma que tem menos resistência ao ar do que a linha redonda de nylon, permite um maior volume de trabalho. • Em comparação com outros fios, o tempo de funcionamento aumenta 20 % com um único carregamento da bateria. • Indicado para máquinas a bateria. 	2,0	15	1	E-01769	0088381555487	3,10
		2,0	30	1	E-01775	0088381555494	5,80
		2,0	310	1	E-01781	0088381555500	42,00
Linha Quatro faces 		2,4	15	1	E-01797	0088381555517	3,90
		2,4	30	1	E-01806	0088381555524	7,35
		2,4	225	1	E-01812	0088381555531	44,00
Linha Quatro faces 		2,7	15	1	E-01828	0088381555548	4,45
		2,7	30	1	E-01834	0088381555555	8,15
		2,7	180	1	E-01840	0088381555562	42,00



Cabeça policut

Tipo de cabeça	Rosca	Modelo	Descrição	Un.	Código	EAN	P.V.P. (€)	
	Policut	Universal	"Recomendado para modelos a bateria"	Cabeça de lâminas oscilantes substituíveis	1	197188-6	0088381458214	28,00
	Jogo de lâminas Policut	Universal	"Recomendado para policut"	12 lâminas	1	197189-4	0088381458276	22,00
	Policut curva	Universal	"Recomendado para modelos a bateria"	Cabeça de lâminas oscilantes substituíveis	1	198383-1	0088381488129	26,00
	Jogo de lâminas Policut	Universal	"Para policut curva"	3 lâminas	1	198426-9	0088381488143	13,25

Óleos

Óleo de 2T mineral



Quantidade	Un.	Código	EAN	P.V.P. (€)
100 ml	1	980008106	4002829239551	1,90
1 Litro	1	980008107	4002829000274	6,70
1 Litro com doseador	1	980008112	4002829414477	11,35
5 Litros	1	980008118	4002829486030	31,00

Óleo de 4T HD30 Monograu



Quantidade	Un.	Código	EAN	P.V.P. (€)
600 ml	1	980008120	4002829441336	4,10

Óleo de 4T SJ10W30 Multigräu



Quantidade	Un.	Código	EAN	P.V.P. (€)
80 ml	1	196122-3	-	2,60
100 ml	1	197010-7	0088381452731	5,15

Óleo de 4T 5W30 Multigräu



Quantidade	Un.	Código	EAN	P.V.P. (€)
1 Litro	1	980008121	4002829760475	7,70

Óleo de 2T sintético



Quantidade	Un.	Código	EAN	P.V.P. (€)
1 Litro	1	980008103	4002829760314	11,85

Óleo de corrente Biotop (Biodegradável)



Quantidade	Un.	Código	EAN	P.V.P. (€)
1 Litro	1	980008210	4002829155028	5,95
5 Litros	1	980008211	4002829155035	29,00

Óleo de corrente



Quantidade	Un.	Código	EAN	P.V.P. (€)
1 Litro	1	988002256	4002829137390	4,40
5 Litros	1	988002258	4002829137406	18,55

Líquido de limpeza de correntes



Quantidade	Un.	Código	EAN	P.V.P. (€)
500 ml	1	980008125	4002829441343	9,25

Arneses para roçadoras



- Arnês profissional, muito ergonómico, perfeito para dias de trabalho longos.
- Reduz a tensão na zona lombar e nos ombros.
- Melhora a manobrabilidade.
- Amplo protetor lombar que ajuda a não carregar as ancas.
- Arnês totalmente ajustável.

Modelos	Un.	Código	EAN	P.V.P. (€)
Todos os modelos	1	196335-6	0088381423694	51,00
	1	196129-9	0088381442459	51,00



Modelos	Un.	Código	EAN	P.V.P. (€)
Arnês para roçadoras em PDC1200	1	191E43-4	0088381556859	13,55



Modelos	Un.	Código	EAN	P.V.P. (€)
Todos os modelos	1	122907-1	0088381426909	25,00



Modelos	Un.	Código	EAN	P.V.P. (€)
Válido para roçadoras e bateria de mochila PDC01.	1	197243-4	0088381454285	5,65

Protecção

Viseiras protetoras



P-47363



P-47357

Descrição	Un.	Código	EAN	P.V.P. (€)
Viseira protetora transparente com borracha	1	P-47363	0088381977791	10,30
Viseira protetora metálica com borracha	1	P-47357	0088381977784	8,50

Protecção auditiva



Descrição	Un.	Código	EAN	P.V.P. (€)
Protecção auditiva	1	988000040	4002829215838	27,00

Acessórios para perfurador DDG460

Brocas para perfurador DDG460



Ø (mm)	Comprimento (mm)	Un.	Código	EAN	P.V.P. (€)
100	800	1	E-07294	0088381572439	100,00
150	800	1	E-07303	0088381572446	117,00
200	800	1	E-07319	0088381572453	138,00

Prolongador



Comprimento (mm)	Un.	Código	EAN	P.V.P. (€)
540	1	E-07325	0088381572460	31,00

Lâmina



Ø (mm)	Un.	Código	EAN	P.V.P. (€)
100	1	E-07630	0088381574518	11,25
150	1	E-07646	0088381574525	12,35
200	1	E-07652	0088381574532	14,45

Adaptador para broca



Descrição	Un.	Código	EAN	P.V.P. (€)
Perno	1	E-07331	0088381572477	3,20

Adaptador para broca



Descrição	Un.	Código	EAN	P.V.P. (€)
Adaptadores	1	327685-0		36,00
	1	327684-2	0088381580175	31,00
	1	327687-6	0088381574471	27,00

Conjunto cabo DDG460



Descrição	Un.	Código	EAN	P.V.P. (€)
Cabo	1	191P11-3	0088381576994	143,00



Brocas de solo 3/4"

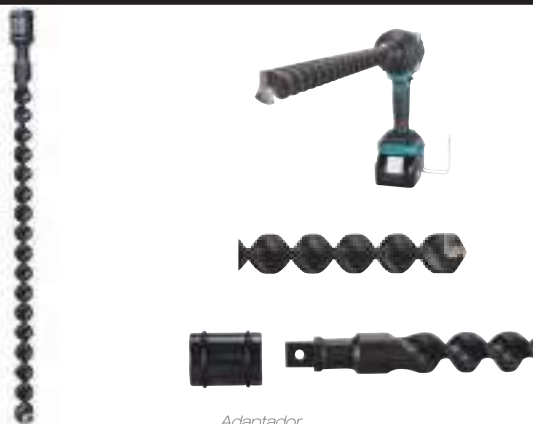

Broca

Adaptador

Modelo	Descrição	Un.	Código	EAN	P.V.P. (€)
DTW1001	Ø 20 mm/600 mm	1	B-54346	0088381477468	185,00
	Ø 25 mm/600 mm	1	B-54352	0088381477475	190,00
	Ø 30 mm/600 mm	1	B-54368	0088381477482	214,00
	Ø 35 mm/600 mm	1	B-54374	0088381477499	253,00
	Adaptador 3/4"	1	B-54380	0088381477505	47,00



Acessórios para DUC122 e UC120D



Modelo	Descrição	Un.	Código	EAN	P.V.P. (€)
DUC122	Extensão	1	195595-7	0088381398510	190,00
UC120D	Extensão 1,3 - 2,2 m.	1	192755-2	0088381146142	194,00



Modelo	Descrição	Un.	Código	EAN	P.V.P. (€)
DUC122	Lima	1	953003090	4002829111703	2,15



Modelo	Descrição	Un.	Código	EAN	P.V.P. (€)
DUC122	Óleo	1	199897-3	0088381582131	4,10

Chave de fendas de regulação



Descrição	Un.	Código	EAN	P.V.P. (€)
Chave de fendas Philips n.º 2	1	783002-8	0088381102650	1,80
Regulação do carburador	1	783012-5	0088381417839	0,55



Lâminas e acessórios para tesouras de poda



197367-6



197366-8

Modelo	Descrição	Un.	Código	EAN	P.V.P. (€)
DUP361	Lâmina fixa	1	197367-6	0088381465373	44,00
	Lâmina móvel	1	197366-8	0088381463720	50,00
DUP362	Lâmina fixa	1	199169-6	0088381526425	123,00
	Lâmina móvel	1	199168-8	0088381526418	98,00



A-86664



B-05016

Modelo	Descrição	Un.	Código	EAN	P.V.P. (€)
4604D	Lâmina fixa	1	A-86664	0088381150965	46,00
	Lâmina móvel	1	B-05016	-	32,00

Arnês para tesoura de poda DUP361/362



Descrição	Un.	Código	EAN	P.V.P. (€)
Arnês para DUP361 e DUP362	1	161377-9	0088381473750	35,00

Lima de diamante e óleo



Modelo	Descrição	Un.	Código	EAN	P.V.P. (€)
4604D DUP361 DUP362	Lima de diamante	1	794530-8	0088381116893	12,35
	Óleo	1	182470-6	0088381498135	1,40



Acessórios para corta-sebes e corta-relvas

TIPO A | Forma otimizada da lâmina para um corte suave.



- Lâminas afiadas:
- Lâmina superior... curvada para baixo.
- Lâmina inferior... curvada para cima.

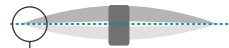

- Ponto de contacto de ambas as lâminas.

- Os ramos são apanhados com facilidade e aguentam-se firmemente entre as lâminas.

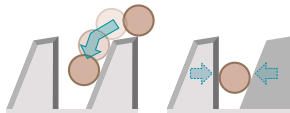

TIPO B | Lâmina livre de manchas

- Niquelagem não-eletrolítica
- Revestimento de superfície uniforme e bem aderido, apresentando uma superfície altamente resistente à abrasão para um revestimento de longa duração.



Seiva na folha
(após 10 horas de trabalho)



Sem manchas na lâmina



Os nossos modelos atuais

Lâmina completa



Comprimento (mm)	Modelo	Tipo	Un.	Código	EAN	P.V.P. (€)
200	UH201D	B	1	198408-1	0088381483766	30,00
520	DUH523	B	1	195769-0	0088381398374	92,00
500	DUH501	A	1	199098-3	0088381531795	103,00
600	DUH601 UH004G	A	1	199099-1	0088381531818	103,00
650	DUH651	B	1	196688-3	0088381437547	134,00
750	DUH751 DUH754S	A	1	191D39-9	0088381559492	160,00
500	DUN500W	A	1	191C14-9	0088381559423	129,00
750	DUH751 UH005G	A	1	191R54-7	0088381583510	155,00
600	UH006G	B	1	191R55-5	0088381583527	155,00
750	UH007G	B	1	191R56-3	0088381583534	170,00
480	UH4861	C	1	140830-8	-	62,00
550	UH5570	C	1	194663-3	0088381354141	38,00
650	UH6570	C	1	194666-7	0088381354172	44,00
550	UH5580	C	1	194671-4	0088381360401	77,00
650	UH6580 DUH651	C	1	194673-0	0088381360418	62,00

Pentes corta-sebes/corta-relvas



195272-1



195176-7



191N24-2



191N23-4

Descrição	Un.	Código	EAN	P.V.P. (€)
Pentes corta-sebes DUM604	1	195272-1	0088381362399	23,00
Pente corta-relvas DUM604	1	195176-7	-	49,00
Pentes corta-sebes DUM111	1	191N24-2	0088381580052	22,00
Pente corta-relvas DUM111	1	191N23-4	0088381580045	30,00

Protetores do pente



Descrição	Un.	Código	EAN	P.V.P. (€)
Protetor de pente corta-sebes	1	458342-0	-	4,00
Protetor de pente corta-relvas	1	452055-5	0088381371407	2,40

Punho extensível



Descrição	Un.	Código	EAN	P.V.P. (€)
Cabo extensível DUM604	1	195187-2	0088381362412	58,00
Cabo extensível DUM111	1	198516-8	0088381490238	60,00

Jogo de varetas para HL360D



Descrição	Un.	Código	EAN	P.V.P. (€)
Jogo de varetas	8	UL23-08/C	-	48,00

Lavadoras de alta pressão



Pistolas



Modelo	Material	Un.	Código	EAN	P.V.P. (€)
HW102 HW111	Plástico	1	HW3320152	-	8,65
HW120	Metálica	1	HW41847		51,00
HW131RLW	Metálica	1	HW40925	8016287409254	48,00
HW132	Plástico	1	HW3640920	-	27,00
HW151	Metálica	1	HW41154	8016287411547	24,00
HW1200 HW1300 DHW080	Plástico	1	197842-2	0088381488990	22,00

Lança com bocal



P-64917



197876-5



197824-4

Modelo	Tipo	Un.	Código	EAN	P.V.P. (€)
HW102	Plana	1	HW3640640	-	3,50
HW102 HW111	Turbo	1	HW3320120	-	4,30
HW120	Plana	1	HW46221	-	26,00
HW131RLW	Plana	1	P-64901	0088381995429	38,00
HW131RLW	Turbo	1	P-64917	0088381995436	83,00
HW132	Plana	1	HW3641150	-	10,25
HW132	Turbo	1	HW3640940	-	10,55
HW151	Plana	1	HW40551	8016287405515	29,00
HW151	Turbo	1	HW40167	8016287401678	50,00
HW1200 HW1300 DHW080	Plana	1	197822-8	0088381484626	13,30
	Spray	1	197876-5	0088381496032	24,00
	Turbo	1	197824-4	0088381518383	13,75
	Turbo	1	191U88-8	0088381583855	35,00

Bocais

HW3086



HW3640670

Modelo	Descrição	Un.	Código	EAN	P.V.P. (€)
HW120	Bocal	1	HW3086	-	16,20
HW111 HW132	Bocal	1	HW3640670	-	2,30
HW1200 HW1300	Agulheta em leque	1	191U86-2	0088381583848	25,00

Extensão



Modelo	Material	Un.	Código	EAN	P.V.P. (€)
HW102 HW111	Plástico	1	HW3320130	-	4,30
HW1200 HW1300 DHW080	Plástico	1	197870-7	0088381484671	46,00
HW1200 HW1300	Plástico	1	198909-9	0088381497367	33,00

Mangueira de alta pressão



Modelo	Comprimento	un.	Código	EAN	P.V.P. (€)
HW102	5 m	1	HW3640630	-	10,80
HW111	5,5 m/12 mm	1	HW3640660	-	44,00
HW120	10 m	1	HW3163270	-	160,00
HW131	15 m	1	HW2500390	-	170,00
HW132	8 m	1	HW3641570	-	59,00
HW151	10 m	1	HW3083550	-	75,00

Mangueira desentupidora



Para a limpeza de tubagens.

Modelo	Comprimento	Un.	Código	EAN	P.V.P. (€)
HW102 HW111 HW132	8 m	1	P-64892	0088381995412	43,00
HW131 HW151	8 m	1	P-66503	0088381997034	48,00
HW102 HW111 HW132 HW151	10 m	1	HW41165	8016287411653	62,00
HW102 HW111 HW132 HW151	16 m	1	HW41167	8016287411677	98,00
HW1200 HW1300 DHW080	10 m	1	197837-5	0088381484657	25,00
	15 m	1	197840-6	0088381484664	31,00

Extensão de mangueira de alta pressão



Modelo	Comprimento	Un.	Código	EAN	P.V.P. (€)
HW102	5 m	1	HW41179	8016287411790	26,00
HW111 HW132	8 m	1	HW41181	8016287411813	70,00
HW1200 HW1300 DHW080	5 m	1	197845-6	0088381484688	28,00
	8 m	1	197847-2	0088381484695	38,00
	10 m	1	197850-3	0088381484701	45,00

Escovas



HW41175

HW41163

Modelo	Descrição	Un.	Código	EAN	P.V.P. (€)
HW102 HW111 HW132	Mini escova de chão.	1	HW41175	8016287411752	55,00
HW102 HW111 HW132 HW151	Kit de sucção de água	1	HW41163	8016287411639	56,00
HW1200 HW1300 DHW080	Kit mangueira de aspiração	1	197873-1	0088381484633	35,00

Escovas



*É necessário adaptador HW3082750.

Modelo	Descrição	Un.	Código	EAN	P.V.P. (€)
HW111 HW132 HW151* HW131RLW*	Triangular	1	HW3640950	-	5,95



Modelo	Descrição	Un.	Código	EAN	P.V.P. (€)
HW102 HW111 HW132 HW151	Triangular	1	HW41185	8016287411851	18,00



*É necessário adaptador HW3082750.

Modelo	Descrição	Un.	Código	EAN	P.V.P. (€)
HW111 HW132 HW151* HW131RLW*	Rotativo	1	P-64858	0088381995375	21,00



*É necessário adaptador HW3082750.

Modelo	Descrição	Un.	Código	EAN	P.V.P. (€)
HW131RLW HW111 HW132 HW151	Para solo sem depósito. Adaptador HW40542 incluído	1	HW41849	-	72,00



Modelo	Descrição	Un.	Código	EAN	P.V.P. (€)
HW131RLW HW151	Rotativo	1	HW41187	8016287411875	31,00



Modelo	Descrição	Un.	Código	EAN	P.V.P. (€)
HW1200 HW1300 DHW080	Rotativo	1	197831-7	0088381484640	16,20



Escovas



Modelo	Descrição	Un.	Código	EAN	P.V.P. (€)
HW1200 HW1300 DHW080	Escova triangular	1	197828-6	0088381489010	10,20



Modelo	Descrição	Un.	Código	EAN	P.V.P. (€)
HW1200 HW1300 DHW080	Escova antissalpicos	1	197864-2	0088381496001	23,00

Adaptadores para lavadoras de alta pressão



HW3082750



P-64870



197883-8



197867-6



197853-7

Modelo	Descrição	Un.	Código	EAN	P.V.P. (€)
HW131RLW HW151 HW120	Adaptador	1	HW3082750	-	12,60
Todos os modelos	Conector tipo Gardena	1	P-64870	0088381995399	9,80
HW1200 HW1300 DHW080	Casquilho de segurança	1	197867-6	0088381490221	16,25
HW1200 HW1300 DHW080	Conector rápido	1	197883-8	0088381496049	6,05
HW1200 HW1300 DHW080	Adaptador	1	197853-7	0088381484749	8,40

Depósitos para detergente e detergente neutro



HW3640090



P-64864



197886-2

Modelo	Descriç.	Un.	Código	EAN	P.V.P. (€)
HW102	Depósito detergente	1	HW3640090	-	3,25
Todos os modelos	Detergente neutro 1 L	1	P-64864	0088381995382	17,50
	Agulha de limpeza de agulheta	1	197879-9	0088381496018	2,15
HW1200 HW1300 DHW080	Frasco para detergente	1	197886-2	0088381489003	19,95

Cuba, plataforma e roda de transporte para DCU180



199008-0



199009-8

Modelo	Descrição	Un.	Código	EAN	P.V.P. (€)
DCU180	Plataforma de transporte	1	199009-8	0088381519632	209,00
	Set cuba	1	199008-0	0088381519625	181,00
	Set rodas auxiliares	1	191A01-6	0088381545945	136,00



NOVO **COLEÇÃO**

Porta-ferramentas



Tecnologias:

STRAP/BELT SYSTEM

O sistema de correia com fivelas de desengate rápido nas extremidades permite mudar facilmente de um porta-ferramentas tipo saco para um cinturo de ferramentas leve na cintura. Possibilidade de guardar mais porta-ferramentas no interior.



HEAVY-LOAD SUPPORT SYSTEM

O sistema de suporte de cargas pesadas proporciona uma ajuda adicional para transportar um conjunto de ferramentas, acessórios e porta-ferramentas muito pesados, distribuindo o peso entre a cintura e os ombros. Confortável de usar e reduz a fadiga durante o dia de trabalho graças ao amortecimento extragrosso de 20 mm.

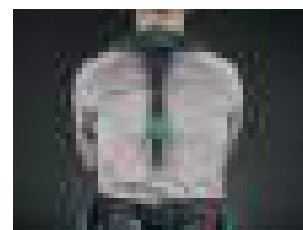

TOOL LOOPS SYSTEM

O sistema inovador de compartimentos especiais permite ao utilizador colocar diferentes ferramentas ou acessórios sem a necessidade de ajustes. O material de alta qualidade garante uma longa vida útil. A combinação de vários tamanhos destes compartimentos permite colocar facilmente ferramentas ou acessórios de diferentes tamanhos da forma adequada.



CS BACKPACK CARRYING SYSTEM

O sistema de transporte de mochila mantém o porta-ferramentas no seu lugar de forma segura para as costas, para ter as mãos completamente livres. É ajustável, o que reduz a fadiga dos ombros. Inclui um bloqueio deslizante para um ajuste rápido.



WATERPROOF BOTTOM

A base impermeável de alta qualidade é uma das grandes vantagens destes porta-ferramentas: rígida, resistente ao desgaste e impermeável, mantém as ferramentas secas e protegidas de superfícies húmidas e molhadas. A base de plástico reforçado também ajuda a manter o porta-ferramentas limpo.



ANTI SLIP

O material antiderrapante minimiza ou até previne acidentes de trabalho por escorregamentos e quedas. A fita de polipropileno de alta qualidade tem uma superfície de borracha que ajuda a manter as ferramentas no lugar e proporciona uma proteção adicional que ajuda a prolongar a vida útil dos produtos.



3 LAYERS

A tecnologia de 3 camadas é uma combinação única de poliésteres e espumas que proporcionam um amortecimento e proteção extra. Concebidos para serem resistentes às intempéries, estes painéis de polipropileno incrivelmente leves são compostos por três camadas firmemente unidas entre si. A característica inovadora destes painéis é a sua capacidade de serem colocados em qualquer espaço.





**REAL
LEATHER**

O couro é macio no exterior e escovado no interior. Forte e resistente para uma longa vida útil, mas macio e flexível o suficiente para um grande conforto, proporcionando ao mesmo tempo uma excelente resistência, especialmente à fricção. O couro foi escolhido para o fabrico de produtos que requerem uma camada mais grossa (de 1,8 a 2,0 mm), o que garante a mais alta qualidade.



**DURABLE
RIVETING**

O rebite duradouro proporciona uma resistência verdadeiramente inquebrável. Rebites autoperfurantes resistentes de uma só peça com arruelas, que são utilizadas em todas as zonas com alta tensão. As arruelas são utilizadas para uma maior resistência num ou em ambos os lados em locais estratégicos, para cima e para baixo.



**LOOP-CLIP
SOLUTION**

A fixação com mosquetão ao cinto é um sistema inovador que permite fixar cada saco de modo fácil, mas seguro. O sistema de bloqueio exclusivo protege a ferramenta ou o acessório contra quedas. Nunca foi tão fácil fixar as suas ferramentas.



**ELASTIC
LOOPS**

Os compartimentos elásticos especiais fixam e mantêm as ferramentas no lugar durante o transporte. Oferece uma grande flexibilidade na organização de ferramentas e acessórios. Estão disponíveis numa ampla variedade dos nossos produtos para garantir a máxima utilização dos mesmos. Os compartimentos são capazes de adaptar-se perfeitamente a todas as ferramentas e acessórios.



**SIDE-GATE
SOLUTION**

O suporte lateral permite colocar facilmente a ferramenta sem olhar para o porta-ferramentas. Uma função de rotação adicional garante que a ferramenta é mantida num ângulo confortável. Fabricado em aço inoxidável para uma maior longevidade do produto e fixado com quatro rebites para maior resistência.



**BELT LOOP
HOLDER**

A correia com presilha de fixação é resistente e permite pendurar qualquer coisa com um mosquetão. Mantém a ferramenta ou o acessório seguro, permitindo que um bolso fique livre. A presilha desliza sobre o cinto e permanece engatada de forma segura.



**RAIL GUIDE
SYSTEM**

O sistema de guia de carril é um sistema de organização extremamente versátil. Uma combinação perfeita de guias laterais de plástico e divisórias que permite a personalização de compartimentos individuais. As divisórias são fabricadas em painéis de núcleo estruturado de 3 camadas. Cada divisória pode ser movida ao longo de carris localizados nas paredes laterais.



Sistema de correia



STRAP

Função de correia

Completamente novo no mercado: o sistema exclusivo de cinto/correia com fivelas de libertação rápida nas extremidades torna-o muito versátil. Usá-lo com uma confortável ombreira de borracha macia torna o levantamento do porta-ferramentas mais confortável.

Adapta-se a todos os porta-ferramentas Makita.



E-05446*
Porta-ferramentas fechado



E-05418*
Porta-ferramentas ajustável



E-05424*
Mala porta-ferramentas reforçado



E-05620*
Geleira com correia

E-05480*
Organizador com quatro bolsas



E-05430
Porta-ferramentas aberto com pega



E-05474*
Organizador com três bolsas

Mais de **40** produtos com este sistema

E-05549*
Saco para motosserra



E-05670
Capa para guia de carril 1 m



E-05664
Capa para guia de carril 1,4 m/1,5 m



E-05452*
Saco porta-ferramentas grande



E-05577*
Saco de lona



E-05505*
Saco para ferramentas e computador portátil



E-05496*
Saco semirrígido



E-05468
Saco porta-ferramentas

E-05561
Saco de tubo para todas as condições meteorológicas



STRAP BELT SYSTEM

BELT



Função de cinto.
 A correia pode ser facilmente removida de qualquer porta-ferramentas e usada à cintura como um cinto de ferramentas de uso leve. A correia pode ser ajustada, tornando-a flexível e conveniente para adaptar-se às suas necessidades. Pode ser usado com qualquer porta-ferramentas Makita.

- E-05583**
Capa vertical para telemóvel
- E-05256***
Porta-ferramentas com clipe
- E-05309***
Jogo de correias com presilha (3 un.)
- E-05315***
Jogo de correias com presilha (6 un.)
- E-05212**
Porta-ferramentas eletricista
- E-05278**
Porta-flexómetro
- E-05228**
Porta-martelo com três compartimentos
- E-05240**
Porta-martelo
- E-05234**
Porta-martelo com fecho
- E-05262**
Porta-tesoura de poda
- E-05599***
Porta-garrafa térmica
- E-05290***
Cinto/asa
- E-05608***
Porta-termo
- E-05181**
Bolsa para eletricista
- E-05131**
Saco multiusos duplo
- E-05094**
Cartucheira grande universal
- E-05103***
Porta-lápis universal
- E-05147**
Organizador com três bolsas
- E-05284***
Porta-cinzel e ferramentas
- E-05206**
Porta-objetos
- E-05153**
Bolsa para carpinteiro
- E-05125***
Bolsa com cartucheira
- E-05197**
Porta-pregos com fixação de martelo
- E-05119**
Cartucheira pequena

* Consultar disponibilidade



Ícones e tecnologias 324 - 326

Sistema de correia 327 - 330

Porta-ferramentas 331 - 350

Cintos e suspensórios 351 - 358

Malas, sacos e mochilas 359 - 366

Roupa, equipamento e capas 367 - 374

Ícones:

Materiais:

-  **Poliéster 600D**
-  **Poliéster 1680D**
-  **Couro de alta qualidade**
-  **Material de borracha**
-  **Malha**
-  **Material antideslizante**
-  **Malha respirável**
-  **Material triplex**
-  **Poliétileno de alta densidade**
-  **Lâmina isolante térmica**
-  **Correias ajustáveis**
-  **Gancho e mosquetão**
-  **Fita elástica**
-  **Fita de polipropileno**
-  **Fecho de correr**

Ferragens e acessórios:

-  **Pega de plástico**
-  **Pega de borracha**
-  **Pega de metal**
-  **Pega de fita de polipropileno com almofada**
-  **Mosquetão de alumínio**
-  **Mosquetão**
-  **Base metálica**
-  **Botão de pressão**
-  **Olhais**
-  **Rebite**
-  **Cinto de orifício duplo**
-  **Suspensórios**
-  **Regulador**
-  **Ajuste da fita**
-  **Fecho do cinto**
-  **Grampo de liberação rápida**
-  **Fivela de liberação rápida**
-  **Alça de ombro acolchoada**
-  **Correia com almofada de borracha**
-  **Estrutura de alumínio**
-  **Bagagem de mão**
-  **Porta-pontas**
-  **Lateral porta-martelos**
-  **Porta-martelos deslizante**
-  **Porta-martelos fixo**
-  **Fita isolante para corrente**
-  **Clipe para fita métrica**
-  **Bolso para smartphone**
-  **Bolso para computador portátil**
-  **Bolso para documento**
-  **Compartimento para cartões de visita**
-  **Suporte para canetas**
-  **Compartimento para cutter**
-  **Compartimento para chave de fendas**
-  **Compartimento para brocas**
-  **Compartimento para lixas manuais**
-  **Compartimento para tenazes**
-  **Compartimento para mosquetão**



Cinto/correia de fecho rápido

- A solução única como cinto de ferramentas de utilização ligeira.
- Adapta-se a todos os sacos e porta-ferramentas, bem como a todos os estojos de ferramentas.
- Este cinto básico é perfeito para diversas atividades de trabalho e possui uma fivela de libertação rápida.
- Serve como base para construir seu próprio conjunto personalizado de cintos com as ferramentas que precisa.



STRAP/BELT
SYSTEM



A solução única para usar como cinto de ferramentas manuais.

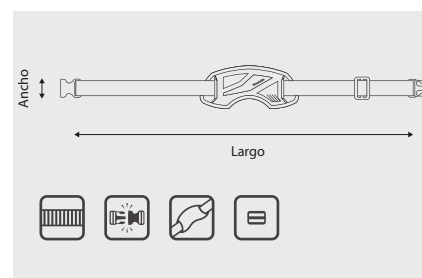

- 1 Fivela de polipropileno de 40 mm.
- 2 Ombreira com desenho ergonómico.
- 3 Regulador de comprimento.
- 4 Correia de alta resistência em azul Makita.

Medidas (C x L x A)	Peso (Kg)	Capacidade (L)	Un.	Código	EAN	P.V.P (€)
1300 x - x 38 mm	0,18	-	1	E-05290	0088381566803	11,85



Fivela de fecho rápido.

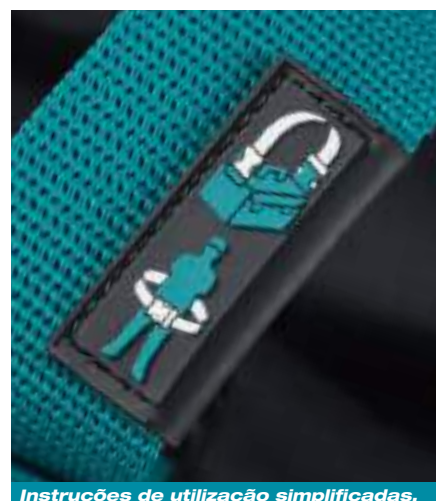

Instruções de utilização simplificadas.

Make It Right, Make It Makita

TECNOLOGIAS

STRAP BELT SYSTEM

ANTI SLIP

3 LAYERS

ELASTIC LOOPS

3D SHAPED POUCHES

SIDE-GATE SOLUTION

BELT LOOP HOLDER

DURABLE RIVETING

REAL LEATHER



Cartucheira grande universal

- 2 compartimentos laterais elásticos.
- 2 compartimentos para brocas de couro genuíno.
- Liberta as suas mãos para se mover em segurança em escadas, telhados e andaimes.
- Porta-ferramentas equilibrado: suporta a maioria dos berbequins de todas as marcas.
- Ferramentas acessíveis, apenas uma posição possível para um melhor equilíbrio.
- Fabricado em poliéster 1680D, resistente para maior durabilidade.



Cinto de couro genuíno com botão de pressão para segurar firmemente o berbequim ao subir ou descer escadas

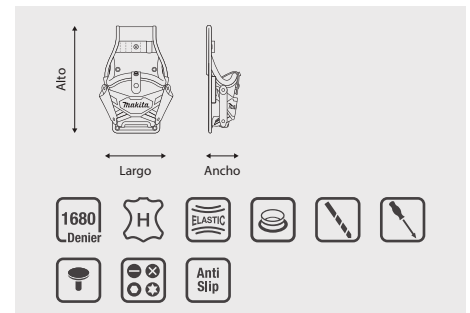

- 1 Rebites e arruelas de níquel para maior resistência e um uso duradouro.
- 2 Compartimento para brocas em pele genuína para um armazenamento prático e fácil.
- 3 Os compartimentos laterais para várias ferramentas e acessórios oferecem uma vasta gama de opções.
- 4 Fita antiderrapante com superfície de borracha na parte superior para evitar acidentes por escorregamento e quedas no local de trabalho.
- 5 Os compartimentos elásticos para brocas proporcionam um armazenamento conveniente.
- 6 Botões de pressão de aço para imobilizar a correia de segurança ao usar o berbequim.
- 7 Os dois botões de pressão fazem com que a capa seja universal para usar com máquinas de diferentes tamanhos.

Medidas (C x L x A)	Peso (Kg)	Capacidade (L)	Un.	Código	EAN	P.V.P (€)
170 X 85 X 290 mm	0,3	-	1	E-05094	0088381566605	28,00



Muito cómodos para canhotos como destros.

Ferramentas não incluídas

Cartucheira pequena

- Fabricada para ser duradoura e leve ao mesmo tempo.
- Pode ser usada em qualquer cinto de ferramentas Makita ou cinto de roupa normal.
- Fácil de manusear com uma mão.
- 2 compartimentos elásticos especiais para uma melhor organização.
- 2 compartimentos especiais para brocas e um suporte aberto para o adaptador de troca rápida.
- Liberta as suas mãos para se mover em segurança em escadas, telhados e andaimes.

STRAP/BELT SYSTEM

ANTI SLIP

3 LAYERS

3D SHAPED POUCHES

REAL LEATHER

DURABLE RIVETING

ELASTIC LOOPS



Cinto de couro genuíno com botão de pressão para segurar firmemente o berbequim ao subir ou descer escadas

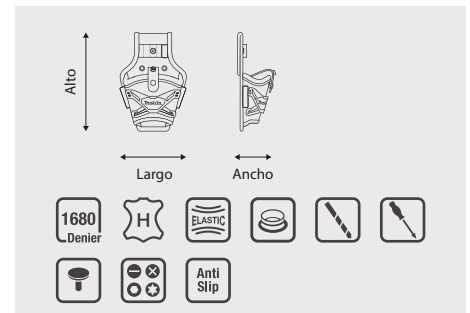

- 1 Os compartimentos elásticos para brocas oferecem um armazenamento prático.
- 2 Botões de pressão em aço inoxidável.
- 3 Compartimento elástico especial para adaptador de troca rápida. A sua construção aberta torna-o mais confortável de usar.
- 4 Fita antiderrapante com superfície de borracha na parte superior para evitar acidentes por escorregamento e quedas no local de trabalho.
- 5 Os rebites e arruelas niquelados proporcionam maior resistência e uma vida útil mais longa.
- 6 Botões de pressão em aço inoxidável para imobilizar a correia de segurança ao usar um berbequim.
- 7 Os compartimentos laterais para várias ferramentas e acessórios oferecem uma ampla variedade de possibilidades.
- 8 Elegante desenho de malha Makita.

Medidas (C x L x A)	Peso (Kg)	Capacidade (L)	Un.	Código	EAN	P.V.P (€)
155 x 75 x 235 mm	0,13	-	1	E-05119	0088381566629	20,10



Muito cómodos para canhotos como destros.

Bolsa com cartucheira

- Seguro, prático e confortável. Tudo em um.
- 4 compartimentos de couro genuíno.
- 6 compartimentos elásticos para uma organização perfeita.
- Tem uma bolsa grande e profunda para ferramentas.
- O interior forrado de poliéster resistente resiste a anos de desgaste.
- Mantém as ferramentas acessíveis quando necessário. Basta pegar nelas e começar a trabalhar!



Desenho de malha elegante Makita na parte frontal do porta-ferramentas rodeado por compartimentos de couro

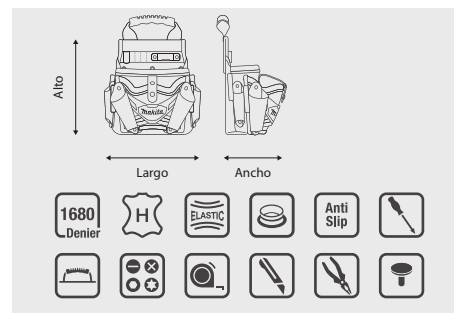

- 1 Correas antiderrapantes com superfície de borracha na parte superior.
- 2 Porta-cortador de couro genuíno.
- 3 Os dois botões de pressão de metal fazem com que a capa seja mais versátil para usar máquinas de diferentes tamanhos.
- 4 A sua pega ergonómica antideslizante proporciona um transporte mais cómodo.
- 5 Os compartimentos elásticos para brocas oferecem um armazenamento prático.
- 6 Cinta com botões de pressão fabricada em aço inoxidável.
- 7 Compartimentos elásticos para ferramentas e os seus acessórios mais essenciais.
- 8 O compartimento para chaves de fendas em pele genuína proporciona um prático armazenamento no interior.

Medidas (C x L x A)	Peso (Kg)	Capacidade (L)	Un.	Código	EAN	P.V.P (€)
260 x 145 x 270 mm	0,55	1,5	1	E-05125	0088381566636	55,00



Compartimentos elásticos no interior.

Bolsa multiusos duplo

- Porta-ferramentas perfeito para começar em conjunto com o cinto de ferramentas.
- 2 bolsos grandes para transportar todas as ferramentas e acessórios necessários.
- 3 compartimentos de couro genuíno.
- 4 compartimentos elásticos para ferramentas.
- A presilha para pendurar várias ferramentas e acessórios permite um armazenamento rápido.
- Forro interior de poliéster durável para resistir a anos de desgaste.



STRAP/BELT SYSTEM

ANTI SLIP

3 LAYERS

3D SHAPED POUCHES

REAL LEATHER

DURABLE RIVETING

ELASTIC LOOPS



A presilha para pendurar várias ferramentas e acessórios oferece um armazenamento fácil e rápido.

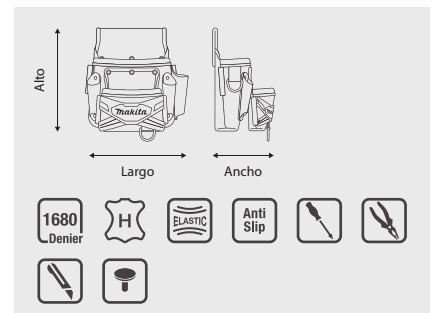

- 1 Porta-chaves de fendas em pele genuína.
- 2 Compartimento largo de couro genuíno para cortador.
- 3 O bolso frontal tem muitas possibilidades e também proporciona uma rápida identificação das ferramentas.
- 4 Presilha para pendurar várias ferramentas e acessórios.
- 5 Banda elástica especial para chaves de fendas e outras ferramentas pequenas.
- 6 Correias antiderrapantes com superfície de borracha.
- 7 Bolso principal com cinta antiderrapante.
- 8 O rebite extra da bolsa proporciona uma vida útil mais longa.

Medidas (C x L x A)	Peso (Kg)	Capacidade (L)	Un.	Código	EAN	P.V.P (€)
290 x 145 x 270 mm	0,66	2,9	1	E-05131	0088381566643	38,00



Porta-ferramentas elásticos no interior

Ferramentas não incluídas

Bolsa para eletricitistas

- Concebida para responder às necessidades do eletricitista profissional.
- 12 compartimentos elásticos na parte dianteira.
- 8 fitas antiderrapantes.
- 3 presilhas elásticas nos lados.
- 2 grandes bolsos principais.
- 1 compartimento de couro e 2 suportes em poliéster nas laterais.



STRAP BELT SYSTEM

ANTI SLIP

3 LAYERS

3D SHAPED POUCHES

REAL LEATHER

DURABLE RIVETING

ELASTIC LOOPS



Os compartimentos elásticos adicionais dentro do porta-ferramentas mantêm as suas ferramentas seguras, bem organizadas e no lugar.

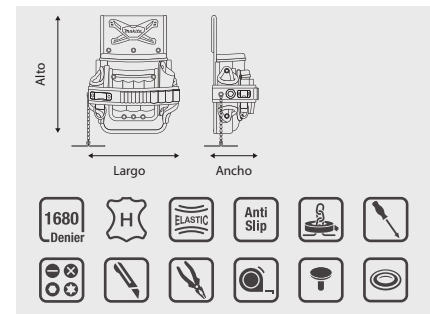

Medidas (C x L x A)	Peso (Kg)	Capacidade (L)	Un.	Código	EAN	P.V.P (€)
250 x 125 x 310 mm	0,55	1,70	1	E-05181	0088381566698	40,00

- 1 Fitas antiderrapantes com superfície de borracha na parte superior.
- 2 Compartimento de couro genuíno para cortador.
- 3 Compartimento elástico para chaves de fendas.
- 4 Porta-fita métrica em aço inoxidável
- 5 Possibilidade de prender um mosquetão na presilha.
- 6 Gancho em T.
- 7 Compartimento elástico externo fora do bolso principal.
- 8 Compartimento para ferramentas em poliéster de borracha resistente.
- 9 Bolso frontal para qualquer tipo de ferramenta de eletricitista.
- 10 Compartimento lateral adicional fabricado em material de 3 camadas.



Bolso principal para guardar ferramentas de eletricitista

Ferramentas não incluídas

Organizador com 3 bolsas

- 3 bolsos espaçosos para uma variedade de ferramentas e acessórios.
- 2 compartimentos de couro genuíno.
- Transporta tudo: pregos, peças, ferramentas, parafusos, lápis, etc.
- Capaz de ser operado com uma mão.
- Todas as ferramentas necessárias ao seu alcance.
- Contém vários bolsos e compartimentos para uma organização perfeita.



STRAP/BELT SYSTEM

ANTI SLIP

3 LAYERS

3D SHAPED POUCHES

REAL LEATHER

DURABLE RIVETING

ELASTIC LOOPS



Os compartimentos extra dentro da bolsa localizados na parede traseira mantêm as suas ferramentas seguras e protegidas.

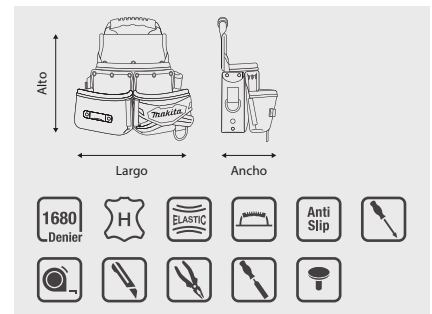

Medidas (C x L x A)	Peso (Kg)	Capacidade (L)	Un.	Código	EAN	P.V.P (€)
320 x 145 x 270 mm	0,67	3,3	1	E-05147	0088381566650	49,00



- 1 O porta-cinzel, fabricado em couro genuíno, extrarrebitado, protege a ferramenta corretamente.
- 2 A presilha para pendurar várias ferramentas e acessórios oferece um armazenamento extra fácil e rápido.
- 3 A sua pega ergonómica com cinta antideslizante proporciona um transporte cómodo.
- 4 O compartimento de aço inoxidável para a fita métrica suporta qualquer fita padrão de 3 a 10 m.
- 5 Compartimentos laterais elásticos para ter todas as ferramentas e acessórios essenciais ao seu alcance.
- 6 Rebites duradouros com arruelas para maior resistência.
- 7 As correias antiderrapantes com superfície de borracha na parte superior evitam acidentes por escorregamento e quedas no local de trabalho.
- 8 O organizador encaixa confortavelmente em qualquer cinto de ferramentas Makita ou cinto de roupa normal.
- 9 Logótipo da Makita visível, desenho de malha moderno Makita.
- 10 O bolso frontal tem muitas possibilidades e também proporciona uma rápida identificação da ferramenta ou acessório.

Bolsa para carpinteiro

- Bolsa grande ideal para carpinteiros, jardineiros e/ou todo o pessoal de manutenção.
- Organiza cuidadosamente uma variedade de ferramentas manuais e evita que elas caiam.
- Pode ser usada com qualquer ferramenta.
- 3 compartimentos de couro nas laterais.
- 3 compartimentos elásticos azuis.
- 2 presilhas para pendurar qualquer coisa com um mosquetão.



STRAP/BELT SYSTEM

ANTI SLIP

3 LAYERS

3D SHAPED POUCHES

REAL LEATHER

DURABLE RIVETING

ELASTIC LOOPS

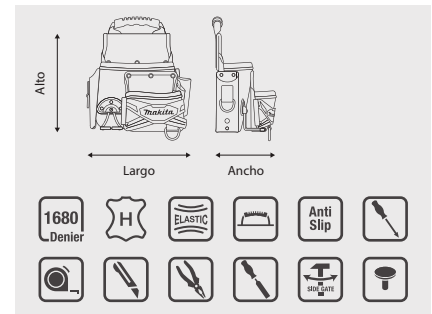

- 1 Compartimento para chaves de fendas em pele genuína.
- 2 Porta-facas de couro genuíno.
- 3 O bolso frontal oferece muitas possibilidades e permite a identificação rápida das ferramentas.
- 4 Presilha para pendurar várias ferramentas e acessórios.
- 5 O porta-martelo de aço inoxidável na lateral balança para manter sempre o martelo na posição vertical
- 6 O porta-cinzel, fabricado em couro genuíno, extrarrebicado, protege a ferramenta corretamente.
- 7 Compartimentos elástico para ferramentas nas laterais para ter todos os elementos essenciais à mão.
- 8 A pega ergonómica facilita o transporte.

Medidas (C x L x A)	Peso (Kg)	Capacidade (L)	Un.	Código	EAN	P.V.P (€)
290 x 145 x 270 mm	0,66	2,60	1	E-05153	0088381566667	55,00



Compartimentos elásticos extra no interior do porta-ferramentas

Porta-bolsas com correia

- Mantém as ferramentas e acessórios ao seu alcance, apenas na cintura!
- 5 bolsos espaçosos.
- 6 compartimentos de couro com resistência e durabilidade confiáveis.
- 2 presilhas para a correia incluídas.
- 10 compartimentos elásticos para um fácil acesso a ferramentas e chaves de fendas adicionais fora dos bolsos.



ANTI SLIP

3 LAYERS

3D SHAPED POUCHES

REAL LEATHER

DURABLE RIVETING

ELASTIC LOOPS

SIDE-GATE SOLUTION

BELT LOOP HOLDER



Dois bolsos principais profundos para um armazenamento seguro das ferramentas, dois bolsos frontais e um bolso mais pequeno no meio.

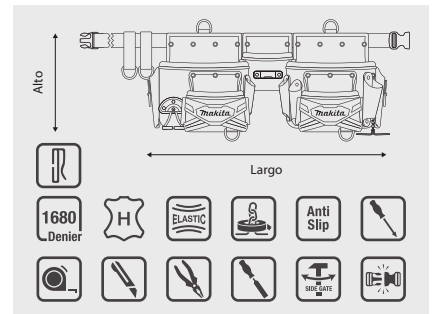

Medidas (C x L x A)	Peso (Kg)	Capacidade (L)	Un.	Código	EAN	P.V.P (€)
640 x 145 x 270 mm	1,34	6,50	1	E-05169	0088381566674	113,00



Ferramentas não incluídas

**Três bolsas
Cinco bolsos
Trinta compartimentos**



- 1 Presilha na extremidade do cinto para evitar que caia.
- 2 2 presilhas para o cinto incluídas.
- 3 Presilha para pendurar várias ferramentas e acessórios.
- 4 Porta-cinzel fabricado em couro genuíno.
- 5 Presilha adicional para usar com mosquetão.
- 6 Porta-martelo de aço inoxidável.
- 7 Compartimentos elásticos no interior.
- 8 Presilhas.
- 9 2 presilhas para pendurar qualquer utensílio com um mosquetão.
- 10 Porta-chaves de fendas em pele genuína.
- 11 Construção robusta com vários rebites adicionais.
- 12 Porta-fita métrica em aço inoxidável
- 13 Porta-ferramentas em couro.
- 14 Compartimento especial para chaves de fendas.
- 15 Bolso frontal com muitas possibilidades e ferramentas mais pequenas.
- 16 Compartimentos elásticos especiais no interior do bolso principal.
- 17 Correias antiderrapantes com superfície de borracha na parte superior.
- 18 Porta-cortador de couro genuíno.
- 19 Gancho em T
- 20 Gancho em forma de fivela de libertação rápida de 40 mm.



Adapta-se a todos os tamanhos de cintura

 Ferramentas não incluídas

Cinto completo

- Distribui o peso das ferramentas uniformemente ao redor da cintura para maior conforto ao longo do dia.
- Totalmente personalizável. Pode ser carregado com vários tipos de porta-ferramentas.
- Conjunto de cinto extra confortável para serviço pesado com todo o equipamento necessário à volta da cintura.
- Capaz de armazenar tudo: peças sobressalentes, ferramentas, brocas, lápis, etc. (acessórios e ferramentas não incluídos).
- Acolchoamento de malha respirável para o calor e o frio.



STRAP/BELT SYSTEM

ANTI SLIP

3 LAYERS

3D SHAPED POUCHES

REAL LEATHER

DURABLE RIVETING

ELASTIC LOOPS

BELT LOOP HOLDER



2 bolsos principais grandes para o armazenamento seguro de ferramentas, 2 bolsos frontais de amplas possibilidades e um bolso mais pequeno no meio.

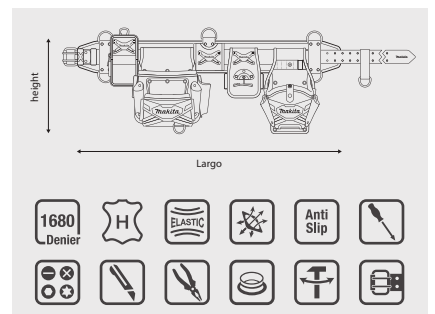

Medidas (C x L x A)	Peso (Kg)	Capacidade (L)	Un.	Código	EAN	P.V.P (€)
310 x - x 880 mm	1,73	2,78	1	E-05175	0088381566681	139,00



Suporte para telemóvel com bolsos frontais elásticos.

Quarenta compartimentos e diversos bolsos



Logótipo Makita visível no porta-ferramentas.

- 1 Fivela de cinto com pino duplo para maior resistência e segurança.
- 2 Presilha de cinto Makita.
- 3 Presilha de cinto de couro.
- 4 Presilha para enganchar suspensórios.
- 5 Presilha útil para pendurar qualquer utensílio com um mosquetão.
- 6 Fecho de correr.
- 7 Bolso principal plano elástico em azul Makita.
- 8 Bolso plano extra elástico na parte dianteira do cinto.
- 9 Compartimentos elásticos laterais para ferramentas pequenas.
- 10 Presilha para pendurar várias ferramentas e acessórios.
- 11 Bolso principal grande para o armazenamento seguro de todas as suas ferramentas principais.
- 12 Bolso frontal para as ferramentas mais pequenas.
- 13 Fita antiderrapante com superfície de borracha na parte superior.
- 14 Presilha adicional.
- 15 Compartimento especial para chaves de fendas em pele genuína.
- 16 Compartimento especial para cortador em pele genuína.
- 17 Logótipo da Makita claramente visível na parte de trás.
- 18 Compartimento especial elástico para chaves de fendas.
- 19 Suporte de martelo resistente forjado em aço inoxidável.
- 20 Porta-martelo com capacidade de oscilação para o manter sempre na posição vertical.
- 21 Mistura de couro e fita de polipropileno resistente.
- 22 Compartimento para chaves de fendas em pele genuína.
- 23 Compartimento elástico para brocas na cor Makita.
- 24 Botão de pressão adicional para imobilizar a correia.
- 25 Compartimento elástico para adaptador de troca rápida.
- 26 Botões de pressão para engatar e desengatar rapidamente.
- 27 Fitas antiderrapantes com superfície de borracha na parte superior.
- 28 Construção robusta com rebites de reforço.
- 29 Presilha de 2 camadas.
- 30 A parte principal do cinto é feita em couro de alta qualidade.
- 31 Fita com presilha incluída adicionalmente no cinto.
- 32 Fila dupla de furos para maior resistência e segurança.
- 33 Logótipo Makita visível gravado no cinto.



- Bolso principal grande para guardar as suas ferramentas e acessórios de forma segura.
- Compartimento especial de couro genuíno para cortador.
- Rebites para uma resistência e durabilidade verdadeiramente inquebráveis.
- Bolso frontal para fixações e ferramentas mais pequenas.

- Fabricado em poliéster 1680D resistente.
- Costuras industriais fortes para maior durabilidade.
- Correias antiderrapantes com superfície de borracha na parte superior do cinto.
- Inúmeros compartimentos elásticos para brocas e adaptadores de brocas.
- Dois botões de pressão de metal tornam-no mais versátil.



Cinto de couro genuíno com botão de pressão metálico.



Porta-ferramentas corretamente localizado num dos lados.

Porta-pregos com porta-martelo

- Para qualquer tipo de trabalho: construtores, carpinteiros, mecânicos, eletricitas, trabalhadores, etc.
- Adapta-se confortavelmente a qualquer cinto Makita.
- Transporta tudo: pregos, peças, ferramentas, parafusos, lápis, etc.
- Confortável de usar, mantém as ferramentas indispensáveis ao seu alcance.
- Um bom começo para iniciar o seu jogo de porta-ferramentas Makita.



STRAP/BELT SYSTEM

ANTI SLIP

3 LAYERS

3D SHAPED POUCHES

REAL LEATHER

DURABLE RIVETING

ELASTIC LOOPS

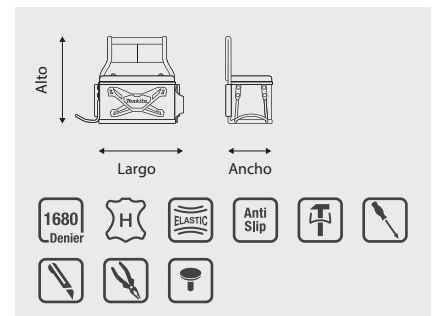

Os compartimentos elásticos mantêm as ferramentas seguras e fixas.

Medidas (C x L x A)	Peso (Kg)	Capacidade (L)	Un.	Código	EAN	P.V.P (€)
180 x 105 x 185 mm	0,25	1,25	1	E-05197	0088381566704	25,00

- 1 Fitas antiderrapantes com superfície de borracha na parte superior.
- 2 Compartimentos elásticos para ferramentas mais pequenas.
- 3 Bolso principal muito versátil.
- 4 Porta-martelo de aço inoxidável.
- 5 Compartimento de couro projetado para pinças.



Também para jardim

Porta-pregos com porta-martelo

Ferramentas não incluídas

Porta-objetos com fecho de correr

- Liberta as suas mãos para se mover em segurança em escadas, telhados e andaimes.
- Porta-objetos perfeito para diversas atividades de trabalho.
- Adapta-se confortavelmente a qualquer cinto Makita.
- Mantém as suas ferramentas à mão quando são necessárias.
- Seguro, prático e confortável.
- Espaço para pregos, peças, ferramentas, jogos de pregos, lápis, etc.

STRAP BELT SYSTEM

3 LAYERS

3D SHAPED POUCHES

DURABLE RIVETING

ELASTIC LOOPS



Porta-fita métrica de aço inoxidável para qualquer fita métrica padrão de 3 a 10 m. A solução perfeita para as suas baterias.

Medidas (C x L x A)	Peso (Kg)	Capacidade (L)	Un.	Código	EAN	P.V.P (€)
175 x 105 x 185 mm	0,24	1,0	1	E-05206	0088381566711	25,00

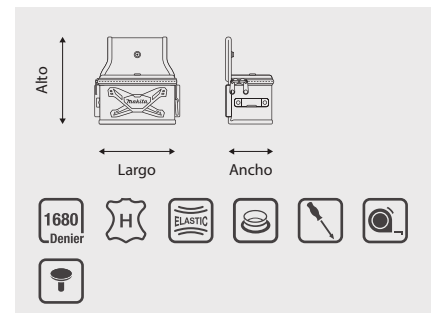

- 1 Com fecho de correr para um armazenamento seguro e à prova de pó.
- 2 Botão de pressão.
- 3 O bolso principal tem capacidade para duas baterias.
- 4 Presilha para pendurar qualquer coisa com engate de mosquetão.
- 5 Compartimentos especiais adicionais para chaves de fendas.



Porta-objetos com compartimentos elásticos

Porta-ferramentas especial para electricista

- Pode ser transportado de 4 formas diferentes, inclusive no cinto.
- Compartimentos seguros em qualquer posição de trabalho.
- 5 compartimentos elásticos para ferramentas na parte frontal para um armazenamento prático.
- 2 compartimentos de couro para maior resistência.
- 2 compartimentos de poliéster nas laterais para uma melhor organização.

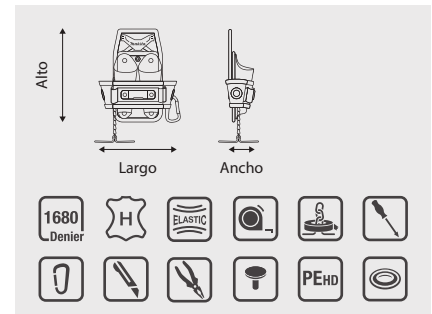

Os compartimentos elásticos mantêm as ferramentas seguras e no seu lugar, imobilizando as ferramentas mais longas.

Medidas (C x L x A)	Peso (Kg)	Capacidade (L)	Un.	Código	EAN	P.V.P (€)
185 x 55 x 205 mm	0,28	-	1	E-05212	0088381566728	25,00

- 1 Parafuso de regulação da intensidade causada pelo balanço.
- 2 Porta-fita métrica em aço inoxidável
- 3 2 compartimentos elásticos laterais para ferramentas.
- 4 2 compartimentos laterais versáteis que prendem as ferramentas maiores e mais pesadas de forma segura.
- 5 Mosquetão preto para fixar qualquer tipo de objeto.
- 6 2 compartimentos de couro versáteis para uma organização segura de ferramentas maiores.
- 7 O gancho em T.
- 8 Costas reforçadas para uma maior ergonomia.



Parafuso para regular a intensidade do balanço

Ferramentas não incluídas

Porta-ferramentas completamente giratório. 4 modos de ajuste



Balanco para manter as ferramentas sempre na posição vertical

- Costas de polipropileno para manter a rigidez e a forma ideal desejada.
- Compartimentos laterais elásticos para ter todas as ferramentas e acessórios à mão.
- O porta-fita métrica suporta qualquer fita padrão de 3 a 10 m.



O porta-ferramentas pode ser pendurado no bolso do peito.



No bolso das calças.



No bolso dianteiro: maior conforto ao ajoelhar-se.



Forma tradicional de transportar o porta-ferramentas num cinto.



Porta-martelo

- O suporte de aço inoxidável adapta-se a qualquer martelo.
- 2 compartimentos elásticos adicionais para lápis ou chave de fendas.
- Adapta-se a qualquer cinto Makita.
- Fabricado em poliéster durável para resistir a anos de desgaste.
- Porta-ferramentas básico perfeito para diversas atividades de trabalho.
- Makita: a marca mais reconhecida em produtos de vestuário de trabalho.

STRAP BELT SYSTEM

3 LAYERS

DURABLE RIVETING

ELASTIC LOOPS

SIDE-GATE SOLUTION



O suporte do martelo de aço inoxidável balança para manter sempre o martelo sempre na posição vertical.

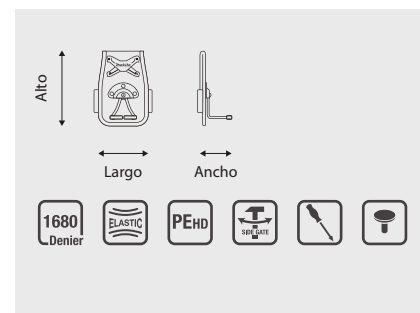

Medidas (C x L x A)	Peso (Kg)	Capacidade (L)	Un.	Código	EAN	P.V.P (€)
880 x 30 x 100 mm	0,66	-	1	E-05234	0088381566742	15,45

- 1 Suporte do martelo em aço inoxidável.
- 2 Polipropileno para manter a rigidez.
- 3 Compartimentos elásticos para todos os acessórios essenciais.
- 4 Cinto de até 50 mm de largura.
- 5 Balanceável para manter o martelo sempre na posição vertical.



Ferramentas não incluídas

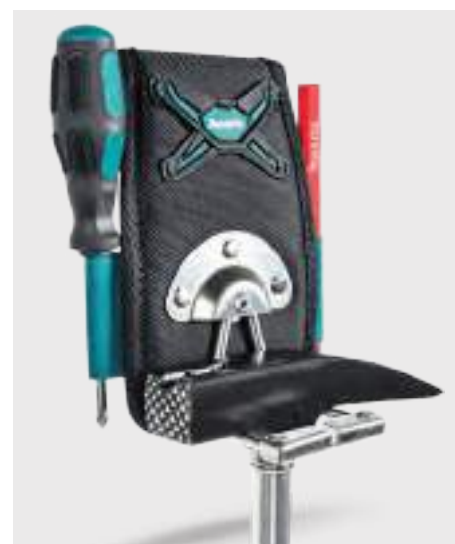

Compatível com todos os tipos de martelos de construção.

Porta-martelo com fechadura

- Porta-ferramentas em aço inoxidável para martelos ou martelos.
- 2 compartimentos elásticos laterais.
- Seguro, prático e confortável.
- Mantém as ferramentas ao seu alcance.
- Adapta-se perfeitamente a qualquer cinto Makita.
- Fabricado em poliéster durável para resistir a anos de desgaste.



STRAP BELT SYSTEM

3 LAYERS

DURABLE RIVETING

ELASTIC LOOPS



Compatível com todos os tipos de martelo para operários, carpinteiros e pessoal de construção.

Medidas (C x L x A)	Peso (Kg)	Capacidade (L)	Un.	Código	EAN	P.V.P (€)
110 x 70 x 165 mm	0,15	-	1	E-05240	0088381566759	14,40

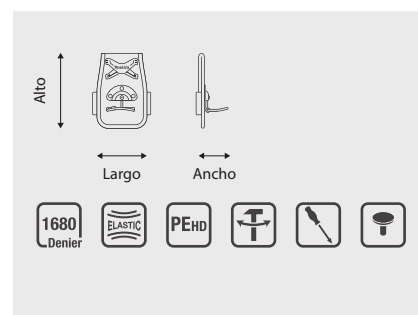

- 1 Porta-ferramentas em aço inoxidável para martelos.
- 2 Capaz de balançar para que o martelo esteja sempre na posição vertical.
- 3 Compartimentos elásticos para todos os acessórios essenciais.
- 4 As presilhas ajustam-se a um cinto de até 50 mm de largura.
- 5 Costas de polipropileno para manter a forma original.



Também para jardim

Também pode usar este porta-ferramentas ao ar livre.

Ferramentas não incluídas

Porta-flexómetro

- Porta-flexómetro ajustável e fácil de usar.
- Especialmente concebido com furos para medir sem retirar a fita.
- 2 compartimentos elásticos para lápis, chaves de fendas e outros acessórios mais pequenos.
- Fabricado em poliéster durável para resistir a anos de desgaste.
- Construído para ser duradouro, mas leve ao mesmo tempo.
- Pode ser usado em qualquer cinto de ferramentas Makita ou cinto de roupa normal.
- Pode ser usado para fitas métricas de 3 a 10 m.

STRAP BELT SYSTEM

ANTI SLIP

3 LAYERS

3D SHAPED POUCHES

DURABLE RIVETING

ELASTIC LOOPS



Fita antiderrapante com superfície de borracha na parte superior para evitar acidentes por escorregamento e quedas no local de trabalho.



Medidas (C x L x A)	Peso (Kg)	Capacidade (L)	Un.	Código	EAN	P.V.P (€)
110 x 80 x 165 mm	0,14	-	1	E-05278	0088381566780	12,35

1 Compartimentos especiais para chaves de fendas e outras ferramentas pequenas.

2 Fecho para telemóvel fixado com dois rebites laterais.

3 Aba para fixar a fita métrica com a opção de movimento tanto para cima como para baixo.

4 Fitas antiderrapantes com superfície de borracha na parte superior.

5 Adapta-se confortavelmente a qualquer cinto Makita de até 50 mm de largura.

6 Orifício na lateral para facilitar o uso sem a remoção da fita métrica.



A parte traseira rígida do porta-flexómetro permite a fácil remoção da fita.

Porta-tesoura de poda

- Porta-ferramentas multiusos (especialmente para tesouras de poda) forrado com poliéster duradouro para resistir ao uso frequente do acessório.
- Forma ergonómica concebida para ser muito versátil para facas, tesouras de podar e outras ferramentas.
- 2 compartimentos elásticos adicionais nas laterais para colocar uma chave de fendas ou um lápis.
- Pequeno, mas muito útil. Mantém as ferramentas ao seu alcance.
- A presilha adapta-se a cintos de até 50 mm de largura.
- Liberta as suas mãos para se mover em segurança em escadas, telhados e andaimes, etc.

STRAP BELT SYSTEM

ANTI SLIP

3 LAYERS

3D SHAPED POUCHES

DURABLE RIVETING

ELASTIC LOOPS



Fita antiderrapante com superfície de borracha na parte superior para evitar acidentes por escorregamento e quedas no local de trabalho.

Medidas (C x L x A)	Peso (Kg)	Capacidade (L)	Un.	Código	EAN	P.V.P (€)
100 x 50 x 200 mm	0,08	-	1	E-05262	0088381566773	13,40

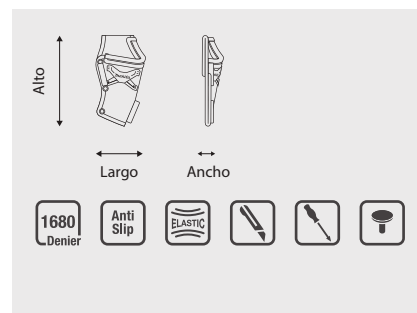

- 1 Fitas antiderrapantes com superfície de borracha na parte superior.
- 2 2 compartimentos elásticos para todos os acessórios importantes.
- 3 Forma especial para tesouras de poda.
- 4 Adapta-se confortavelmente a qualquer cinto Makita.
- 5 Rebites para durabilidade e longa vida útil.



Também para jardim

Também pode usar este porta-ferramentas ao ar livre.

Ferramentas não incluídas

Make It Right, Make It Makita



TECNOLOGIAS

**STRAP / BELT
SYSTEM**

**HEAVY-LOAD
SUPPORT SYSTEM**

**ELASTIC
LOOPS**

**BELT LOOP
HOLDER**

**DURABLE
RIVETING**

**REAL
LEATHER**

Cinto de porta-bolsas

- Perfeito para começar a montar um jogo de porta-ferramentas personalizado.
- Para tarefas muito pesadas. Nunca o dececionará!
- Confortável de usar mesmo quando transporta ferramentas ou acessórios pesados.
- Acabamento extremamente duradouro, acolchoamento extra grosso e fivela de pino duplo.
- Presilha útil para cinto incluída para pendurar qualquer utensílio com um mosquetão.
- Combinação de couro resistente com fita de poliéster leve.



REAL LEATHER



DURABLE RIVETING



BELT LOOP HOLDER

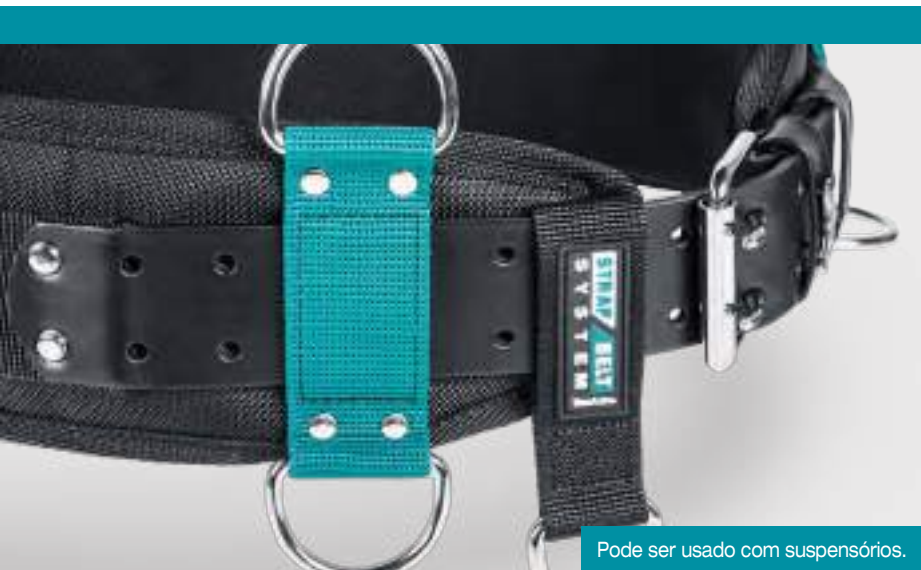

Pode ser usado com suspensórios.

Medidas (C x L x A)	Peso (Kg)	Capacidade (L)	Un.	Código	EAN	P.V.P (€)
880 x 30 x 100 mm	0,66	-	1	E-05321	0088381566834	46,00

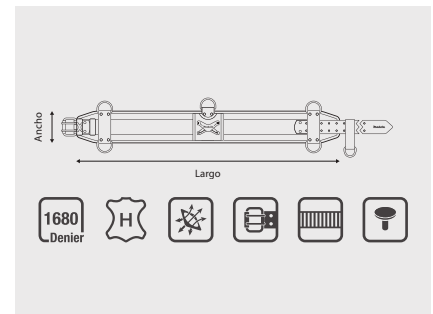

- 1 Fabricado em parte de couro genuíno de alta qualidade.
- 2 Presilhas de metal.
- 3 Presilhas de metal adicionais para acessórios.
- 4 Suporte para cinto incluído.
- 5 Rebites para uma força verdadeiramente inquebrável.
- 6 As costas em malha respirável mantêm o fluxo de ar.
- 7 Presilha de couro adicional para manter o cinto bem ajustado.
- 8 Logótipo de metal da Makita na presilha do cinto.
- 9 Fivela de dois pinos para maior segurança.
- 10 Duas filas de furos de 4,5 mm de diâmetro.



Totalmente acolchoado com espuma de 20 mm de espessura para maior conforto

Cinto básico com fecho rápido

- Cinto básico perfeito para uma variedade de trabalhos.
- Ideal para começar a montar um kit completo de porta-ferramentas.
- Fixado com uma fivela de plástico de alta resistência.
- Presilha útil incluída para pendurar qualquer coisa com um mosquetão.
- Construído para transportar várias bolsas de trabalho leves.
- Costuras duplas à volta do cinto para garantir que os tecidos não se desprendem nem se rasgam.



Correia de polietileno no interior para manter a forma do cinto e evitar que se deforme

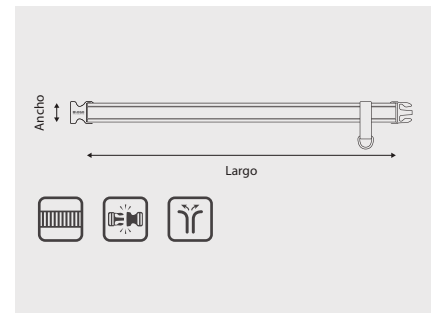

- 1 Fivela de polipropileno de 50 mm de fecho rápido.
- 2 Presilha incluída.
- 3 Adequado para ser usado com qualquer bolsa ou porta-ferramentas Makita.
- 4 Gancho e laço para ajuste de comprimento.
- 5 Logótipo da Makita gravado na fivela.

Medidas (C x L x A)	Peso (Kg)	Capacidade (L)	Un.	Código	EAN	P.V.P (€)
1550 x - x 50 mm	0,25	-	1	E-05337	0088381566841	16,50



Logótipo da Makita gravado na fivela

Cinto de couro com fivela de metal



- Feito a partir de uma única peça de couro genuíno.
- Construção robusta com rebites.
- Os fãs da Makita vão adorar. Ideal para o trabalho e para o uso diário.
- Fivela de metal e cinto de couro preto de 50 mm de largura.
- Presilha útil incluída para pendurar qualquer coisa com um mosquetão.
- Makita: a marca mais reconhecida em produtos de vestuário de trabalho

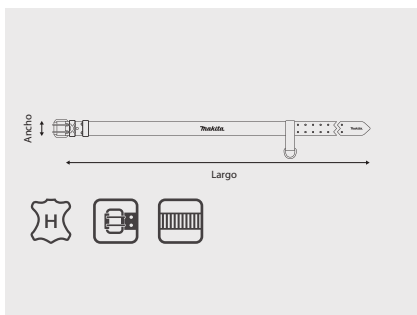

Confeccionado com couro genuíno de uma única peça de primeira qualidade de 50 mm de largura. Adapta-se a todos os tamanhos de cintura.

- 1 Duas filas de furos de 4,5 mm de diâmetro.
- 2 Rebites para maior resistência.
- 3 Fivela resistente e segura.
- 4 Fivela prática.
- 5 Presilha incluída.

Medidas (C x L x A)	Peso (Kg)	Capacidade (L)	Un.	Código	EAN	P.V.P (€)
1380 x - x 48 mm	0,30	-	1	E-05343	0088381566858	28,00



Logótipo metálico Makita na presilha do cinto.



Make It Right, Make It Makita



TECNOLOGIAS

**HEAVY-LOAD
SUPPORT SYSTEM**

ANTI SLIP

Suspensórios porta-ferramentas

- Concebidos para uma utilização profissional.
- Com suporte para smartphone.
- Estrutura antiderrapante, não escorrega nem se desloca dos ombros do utilizador.
- Leve e confortável, mantendo uma elevada resistência e durabilidade.
- Ajuste da correia do peito para se adaptar ao tipo de corpo do utilizador.
- Podem ser combinados com porta-bolsas ou cintos completos para aumentar a capacidade e melhorar o desempenho.

HEAVY-LOAD
SUPPORT SYSTEM

ANTI SLIP



Com um desenho ergonómico que mantém os suspensórios na sua posição ideal durante todo o tempo de utilização. Reduzem a fadiga do utilizador.

Medidas (C x L x A)	Peso (Kg)	Capacidade (L)	Un.	Código	EAN	P.V.P (€)
520 - 23 - 410 mm	0,47	-	1	E-05393	0088381566902	40,00

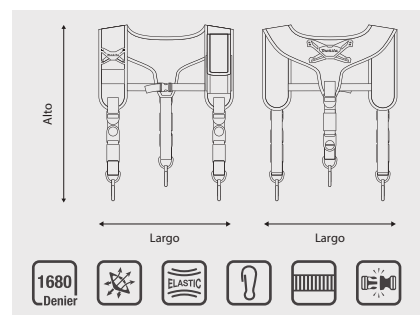

- 1 Parte inferior feita de malha 3D para melhorar a respirabilidade.
- 2 Laterais elásticas do suporte para smartphones.
- 3 Ombreiras adaptativas ergonómicas.
- 4 Reguladores de comprimento.
- 5 Sistema antiderrapante mantém as ombreiras em posição
- 6 Suporte para smartphones.
- 7 Fivela de fecho rápida de 25 mm na correia do peito.
- 8 Fitas elásticas para imobilizar as correias de ajuste de comprimento.
- 9 Ilhós para ajuste rápido do comprimento.
- 10 Mosquetões de metal para conectar ao cinto.



Com parte de fita antiderrapante para pendurar outras ferramentas.

Suspensórios

- Para suportar o peso da cintura até aos ombros.
- Totalmente ajustável, tamanho único.
- Suspensórios com 3 pontos de ajuste que retiram o peso da parte inferior das costas.
- Duradouros e fabricados com uma banda elástica azul robusta.
- Adaptam-se tanto a calças de trabalho como a calças casuais ou calças de ganga.



Concebidos para se adaptarem tanto a calças de trabalho como a calças casuais ou calças de ganga. Para verdadeiros fãs da Makita.

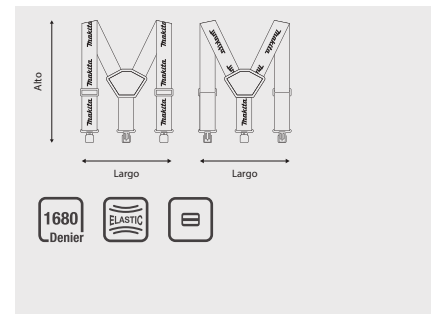

- 1 A almofada acolchoada garante o conforto do utilizador.
- 2 Fabricados com uma banda elástica azul robusta de 50 mm de largura.
- 3 Metal niquelado de alta qualidade.
- 4 Múltiplos logótipos da Makita visíveis.
- 5 Pinças de aço de alta resistência.

Medidas (C x L x A)	Peso (Kg)	Capacidade (L)	Un.	Código	EAN	P.V.P (€)
50 x - x - mm	0,24	-	1	E-05402	0088381566919	24,00



Também para jardim

Tamanho único para todos...

- Concebidos para distribuir o peso entre a cintura e os ombros.
- Recém-desenhados em azul Makita com grandes logótipos da Makita em branco.
- Cor e logótipo reconhecíveis com pouca visibilidade.



Pinças de fixação resistentes

- Suspensórios confortáveis de comprimento ajustável.
- Costuras industriais fortes para maior durabilidade.
- Concebidos para uso profissional.
- Totalmente ajustável, tamanho único.



União acolchoada de ambos os lados

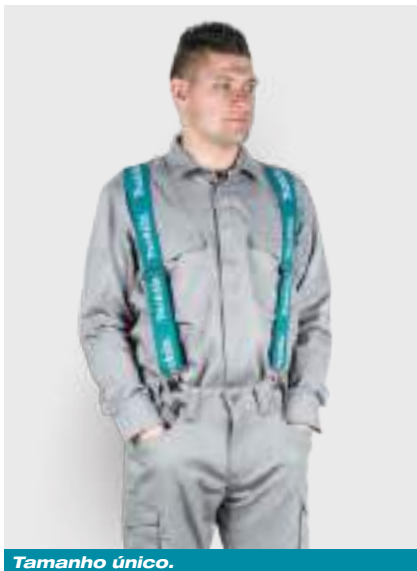

Tamanho único.



Make It Right, Make It Makita

TECNOLOGIAS

STRAP BELT SYSTEM

RAIL GUIDE SYSTEM

TOOL LOOPS SYSTEM

WATERPROOF BOTTOM

CS BACKPACK CARRYING SYSTEM

ELASTIC LOOPS

DURABLE RIVETING

3 LAYERS

ANTI SLIP



Mala porta-ferramentas reforçada

- 20 compartimentos de plástico de vários tamanhos.
- 1 bolso frontal para guardar documentação.
- 3 compartimentos elásticos para uma grande flexibilidade.
- 4 compartimentos espaçosos e totalmente ajustáveis para uma organização ideal.
- Podem ser armazenados pregos, peças, ferramentas, conjuntos de pregos, lápis, etc..
- Perfeito para um electricista, telhador, canalizador, carpinteiro e outros...



O inovador sistema de compartimentos para ferramentas permite ao utilizador colocá-las sem ter que fazer nenhum ajuste.

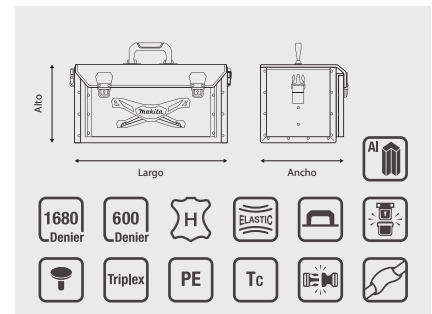

- 1 Guias de carril que dividem a mala em diferentes compartimentos.
- 2 Sistema inovador de compartimentos para ferramentas manuais.
- 3 Bolso frontal para guardar documentos ou outros papéis.
- 4 Bloqueios para manter as ferramentas seguras e imobilizadas.
- 5 Parede transversal.
- 6 As bordas de alumínio evitam danos na carcaça.
- 7 Correia com fivelas de libertação rápida.
- 8 Rebites para maior resistência.
- 9 Logotipo Makita visível na frente.
- 10 Reforço de aba forte com interior reforçado com metal.

Medidas (C x L x A)	Peso (Kg)	Capacidade (L)	Un.	Código	EAN	P.V.P (€)
505 x 295 x 265 mm	3,80	32	1	E-05424	0088381566933	111,00



Bordas de alumínio para proteger contra danos.

Porta-ferramentas aberto com pega

- 9 bolsas exteriores de vários tamanhos feitas de poliéster resistente.
- 2 bolsos laterais com acabamento elástico para maior conforto.
- 1 bolso frontal para documentação ou outros objetos planos.
- 8 compartimentos elásticos no interior de grande flexibilidade.
- 6 compartimentos elásticos na parte traseira para as ferramentas mais compridas.
- Até 30 ferramentas numa posição segura.



- Armazena as ferramentas na vertical para facilitar a sua identificação.
- A forma quadrada mantém o porta-ferramentas estável.
- Os compartimentos elásticos internas proporcionam uma grande capacidade de organização das ferramentas.
- Capaz de transportar até 30 ferramentas manuais de qualquer tipo.
- Desenho aberto para um acesso rápido e fácil ao interior.
- Organize cuidadosamente uma grande variedade de ferramentas manuais, ferramentas elétricas e acessórios.



O sistema inovador de compartimentos para ferramentas permite ao utilizador colocar as ferramentas manuais sem problemas.

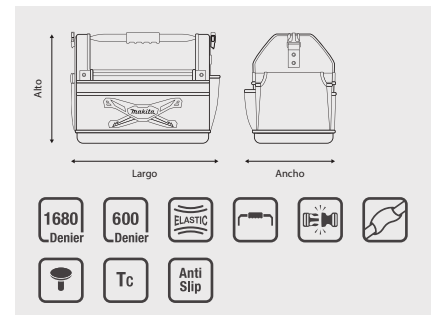

Medidas (C x L x A)	Peso (Kg)	Capacidade (L)	Un.	Código	EAN	P.V.P (€)
490 x 310 x 355 mm	2,44	29,70	1	E-05430	0088381566940	80,00



- 1 Pega de espuma ergonómica.
- 2 Pega de aço resistente.
- 3 Correia de libertação rápida
- 4 Base da correia de aço reforçado.
- 5 Costuras industriais para a correia.
- 6 Bolso frontal para documentação.
- 7 Ombreira confortável de desenho moderno.
- 8 Correia antiderrapante com apoio de borracha para o ombro.
- 9 Compartimentos elásticos nas paredes internas do porta-ferramentas.
- 10 Compartimentos elásticos na parede traseira do bolso.



Saco porta-ferramentas

- Mais de 20 bolsos de diferentes tamanhos para uma organização perfeita.
- Saco macio básico, perfeito para diversas de atividades de trabalho.
- 9 bolsos interiores.
- 9 bolsos exteriores.
- 4 compartimentos elásticos exteriores para ferramentas longas.
- Ideal para transportar ferramentas manuais e outros artigos pequenos.



STRAP/BELT SYSTEM

ELASTIC LOOPS



Bolsos interiores e exteriores para um armazenamento seguro e ordenado.

Medidas (C x L x A)	Peso (Kg)	Capacidade (L)	Un.	Código	EAN	P.V.P (€)
440 x 240 x 250 mm	1,67	25,80	1	E-05468	0088381566971	65,00

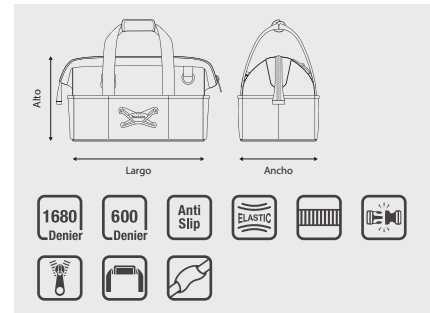

- 1 Grande abertura.
- 2 Acabamento azul da fita interior.
- 3 Fitas antiderrapantes com superfície acolchoada de borracha.
- 4 Presilha para pendurar várias ferramentas e acessórios.
- 5 Logotipo Makita visível na frente.
- 6 Correia com fivela de plástico.
- 7 Ombreira acolchoada.
- 8 Fecho de correr de borracha.
- 9 Fabricado em poliéster 1680D resistente.
- 10 A forma quadrada mantém o saco estável em todos os momentos.



Capaz de transportar uma grande variedade de ferramentas e acessórios.

Saco porta-ferramentas

- Alta capacidade de armazenamento de 55 L
- Confortável mesmo quando se transporta elementos pesados.
- Com 10 compartimentos, 6 no interior e 4 no exterior, ideal para armazenar e organizar objetos de todos os tamanhos.
- Estrutura reforçada que melhora a sua durabilidade para suportar e transportar artigos pesados.
- Com vários tipos de pegas para transportar à mão ou sobre o ombro.
- Estrutura de três camadas que a torna resistente às condições climáticas exteriores.



STRAP/BELT SYSTEM

ANTI SLIP

3 LAYERS



Estrutura reforçada para suportar artigos pesados e proporcionar um transporte confortável.

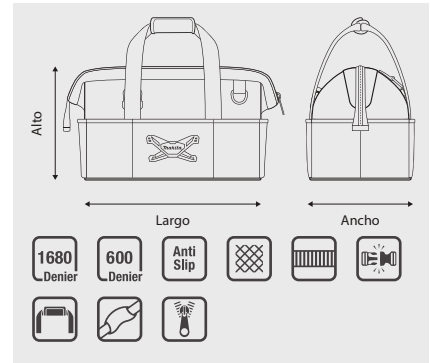

- 1 6 bolsos exteriores.
- 2 4 bolsos interiores.
- 3 Estrutura reforçada para suportar o transporte de artigos pesados.
- 4 Material de camada tripla com alta resistência a condições climáticas adversas.
- 5 Pode ser transportado à mão ou sobre o ombro.
- 6 Capacidade de 55 L.

Medidas (C x L x A)	Peso (Kg)	Capacidade (L)	Un.	Código	EAN	P.V.P (€)
330 x 670 x 300mm	-	55	1	E-11782	0088381584159	108,00



Com fita de velcro para unir ambas as correias ao transportá-lo à mão



Com instruções de utilização acopladas da correia de transporte ao ombro.

Saco trolley reforçado

- Com trolley de transporte, pode armazenar uma grande quantidade de objetos e ainda ser fácil de transportar, apesar do peso.
- Com uma boca de abertura muito larga para poder encaixar objetos de grandes dimensões.
- Com 10 compartimentos, 6 no interior e 4 no exterior, ideal para armazenar e organizar objetos de todos os tamanhos.
- Estrutura reforçada que melhora a sua durabilidade para suportar e transportar artigos pesados.
- Com vários tipos de pegas para transportar à mão ou sobre o ombro.
- Estrutura de três camadas que a torna resistente às condições climáticas exteriores.
- Alta capacidade de armazenamento de 53,5 L.

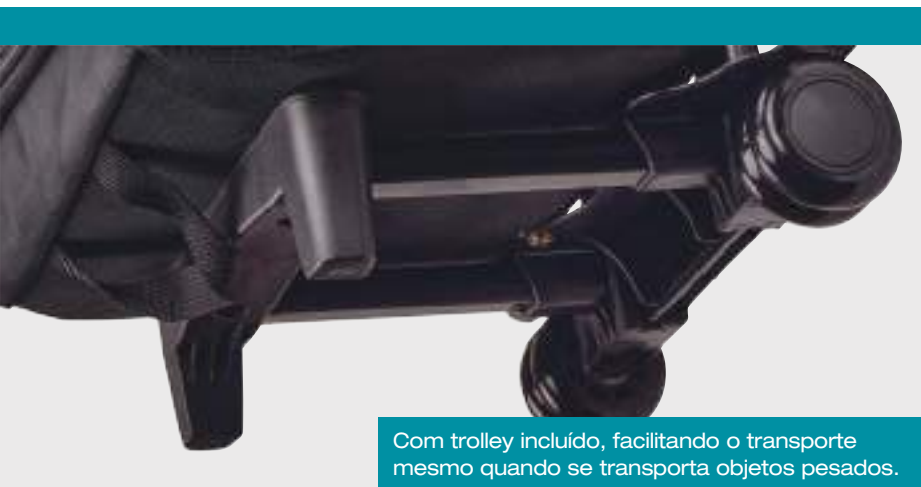

Com trolley incluído, facilitando o transporte mesmo quando se transporta objetos pesados.

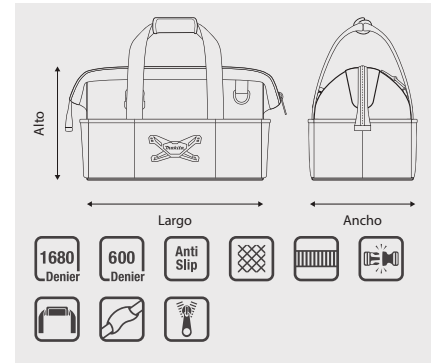

- 1 Abertura principal ampla.
- 2 Com trolley equipado.
- 3 Estrutura reforçada para suportar o transporte de artigos pesados.
- 4 Material de camada tripla com alta resistência a condições climáticas adversas.
- 5 Pode ser transportado à mão ou sobre o ombro.
- 6 Com um grande número de bolsos exteriores e interiores.

Medidas (C x L x A)	Peso (Kg)	Capacidade (L)	Un.	Código	EAN	P.V.P (€)
330 x 680 x 330 mm	-	53,5	1	E-12712	0088381588478	149,00



Com fita de velcro para unir ambas as correias ao transportá-lo à mão



Com instruções de utilização acopladas da correia de transporte ao ombro.

Make It Right, Make It Makita

TECNOLOGIAS

B BACKPACK
C CARRYING
S SYSTEM

ELASTIC
LOOPS

WATERPROOF
BOTTOM

TOOL
LOOPS
SYSTEM

Mochila com organizador de ferramentas

- Fácil organização e transporte de qualquer tipo de ferramenta
- Ideal para trabalhadores da construção, electricistas, operários de reparação...
- Uma alternativa mais fácil de transportar do que uma mala de ferramentas.
- Permite-lhe ter as mãos livres durante o transporte.
- Pode alojar com segurança até 50 ferramentas manuais numa posição vertical.
- Com um grande número de compartimentos e engates.

WATERPROOF
BOTTOM

CS
BACKPACK
CARRYING
SYSTEM

TOOL
LOOPS
SYSTEM

ELASTIC
LOOPS



Bolso exterior com fecho de aba para um armazenamento seguro

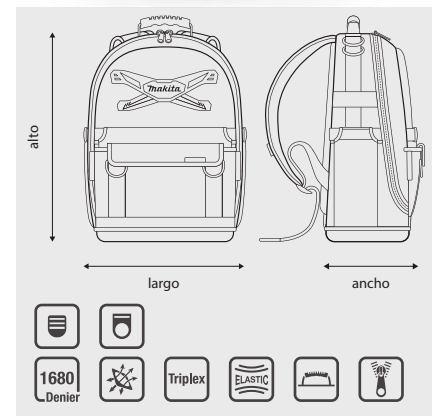

Medidas (C x L x A)	Peso (Kg)	Capacidade (L)	Un.	Código	EAN	P.V.P (€)
390 x 230 x 490 mm	2,56	22,30	1	E-05511	0088381567022	149,00

- 1 Bolso lateral para ferramentas longas.
- 2 Fita elástica para manter as ferramentas em posição e seguras.
- 3 Dois anéis para pendurar ferramentas com um mosquetão.
- 4 Paineis traseiros reforçados.
- 5 Correia lateral para maior segurança das ferramentas alongadas.
- 6 Carril de plástico para armazenar todo o tipo de objetos.
- 7 Fitas para segurar as ferramentas no lugar.
- 8 Fita elástica preta para fixar ferramentas curtas.
- 9 Fita elástica azul para fixar ferramentas de tamanho médio.
- 10 Fita preta para imobilizar ferramentas alongadas.



Anéis para fixar ferramentas com mosquetão.

Ferramentas não incluídas

Make It Right, Make It Makita



TECNOLOGIAS

STRAP / BELT SYSTEM

ANTI SLIP

3 LAYERS

ELASTIC LOOPS

WATERPROOF BOTTOM

DURABLE RIVETING

LOOP-CLIP SOLUTION

Capa vertical para telemóvel

- Desenho moderno, também para uso diário. Os fãs da Makita vão adorar!
- Vantagem única: engate rápido na parte posterior.
- O tamanho é universal, adapta-se aos modelos de smartphone mais populares.
- Prático bolso frontal para cartões de visita, cartões de crédito ou licenças....
- Mosquetão para as chaves, mais o compartimento elástico para canetas
- As múltiplas camadas de revestimento de espuma e malha de ar proporcionam a proteção necessária no trabalho.



STRAP/BELT SYSTEM

ELASTIC LOOPS

LOOP-CLIP SOLUTION

3 LAYERS



O seu desenho e construção garantem a máxima proteção.

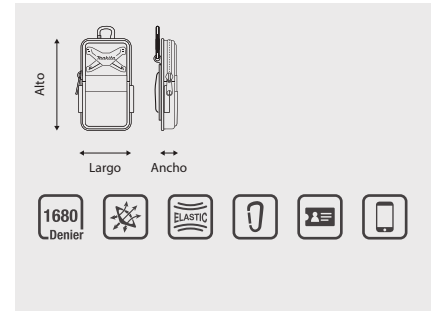

Medidas (C x L x A)	Peso (Kg)	Capacidade (L)	Un.	Código	EAN	P.V.P (€)
90 x 40 x 165 mm	0,12	0,18	1	E-05583	0088381567091	19,55



- 1 Logo da Makita visível num desenho de borracha moderno.
- 2 Bolsos na parte frontal para cartões de visita.
- 3 Bolsos elásticos muito práticos.
- 4 Compartimentos elásticos para acessórios nas laterais.
- 5 Fecho de correr para guardar o telemóvel de forma segura.
- 6 Puxador do fecho de correr de grande durabilidade e resistência.
- 7 Desenho moderno de borracha da Makita.
- 8 Mosquetão para engatar rapidamente a presilha das calças ou cinto.
- 9 Compartimento para gancho atrás do suporte da capa.
- 10 Compartimento elástico útil para caneta ou chave de fendas.



Bolso para proteger os objetos de valor.

Ferramentas não incluídas

Capa para smartphone XL

- Proteja o seu smartphone de possíveis quedas.
- Ideal para armazenar telemóveis grandes ou pequenos.
- Com 2 bolsos exteriores e 2 fitas elásticas para canetas, mais um bolso especial para cartões no interior.
- Maior do que o modelo E-05583 (de 148 mm a 172 mm de altura).
- Com uma pinça e um mosquetão para engatar nos cintos e uma variedade de ilhós.
- Estrutura de três camadas que a torna resistente às condições climáticas exteriores.

STRAP/BELT SYSTEM

ELASTIC LOOPS

LOOP-CLIP SOLUTION

3 LAYERS



A pinça incorporada na parte posterior torna-o ideal para engatar em cintos.

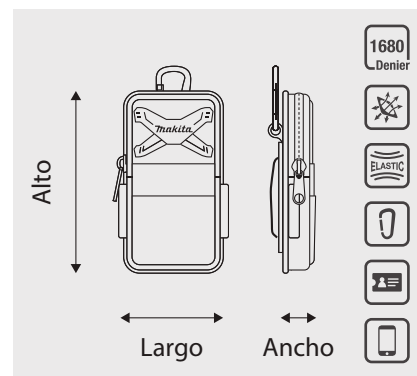

- 1 Maior do que os modelos anteriores
- 2 Fitas para armazenar canetas
- 3 2 bolsos frontais.
- 4 Mosquetão.
- 5 Pinça traseira.
- 6 Estrutura de três camadas que a torna resistente às condições climáticas exteriores.

Medidas (C x L x A)	Peso (Kg)	Capacidade (L)	Un.	Código	EAN	P.V.P (€)
115 x 40 x 200 mm	-	-	1	E-12980	0088381589963	21,00



Bolso interior para proteger os objetos de valor.

Geleira

- Fabricada em poliéster 1680D resistente.
- Pega de transporte confortável.
- Perfeito para a construção, o escritório ou um piquenique familiar.
- Protege os alimentos do pó e dos resíduos da construção civil.
- A sua construção robusta evita fugas.
- O saco é espaçoso e pode guardar o almoço para o dia inteiro de trabalho.



3 LAYERS



Perfeita para o local de trabalho, o escritório ou um piquenique familiar.

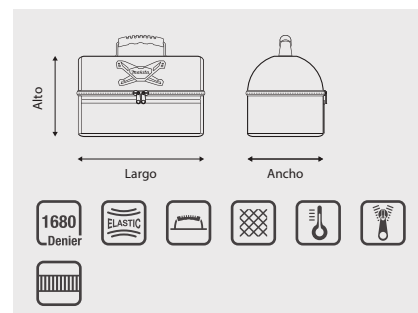

- 1 Rede prática na frente como um bolso exterior.
- 2 Fecho de correr para facilitar a abertura.
- 3 A sua forma ergonómica mantém o saco estável em qualquer altura.
- 4 Forro de pepel de alumínio de fácil limpeza.
- 5 Pega de borracha para um transporte confortável.

Medidas (C x L x A)	Peso (Kg)	Capacidade (L)	Un.	Código	EAN	P.V.P (€)
330 x 180 x 210 mm	0,45	7,5	1	E-05614	0088381567121	33,00



Conteúdo não incluído

Colete porta-ferramentas

- Uma alternativa ao porta-ferramentas tradicional.
- Liberta as suas mãos para se mover em segurança em escadas, telhados e andaimes, etc.
- Dispõe de vários bolsos exteriores para uma organização perfeita.
- Tamanho único com ajuste.
- Construção leve para o conforto do utilizador.
- Pode ser usado por cima de uma T-shirt, camisola ou casaco.

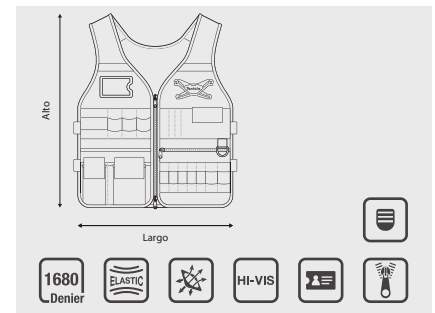

- 1 Fitas ajustáveis nas laterais em função do tamanho.
- 2 Faixa refletora para maior segurança durante o trabalho.
- 3 Plástico transparente para cartão de identificação ou cartão de crédito.
- 4 Os compartimentos elásticos mantêm as suas ferramentas fixas.
- 5 Bolso estreito com aba para um armazenamento seguro.
- 6 Bolsa larga com aba com fecho de segurança para guardar os objetos de valor de forma segura.
- 7 Desenho moderno de borracha.
- 8 Bolso com fecho de correr.
- 9 Compartimentos elásticos para canetas, lápis ou quaisquer outros objetos.
- 10 Fecho elástico para o telemóvel.

Medidas (C x L x A)	Peso (Kg)	Capacidade (L)	Un.	Código	EAN	P.V.P (€)
510 x 640 mm	0,81	-	1	E-05636	0088381567145	72,00



Capas para guias de carril

- Concebidas para conter até 2 guias de carril, conectores e suportes.
- A capa adapta-se às guias de carril e protege-as de arranhões e pancadas durante o transporte e armazenamento.
- Correia de gancho ajustável, bolso frontal com fecho de correr, bolsos interiores para imobilizar as guias de carril mais curtas.
- Duradoura e leve com forro de espuma para uma proteção adicional.
- Com pega ergonómica para o seu transporte e alça para o ombro.

STRAP/BELT
SYSTEM

3 LAYERS



Bolso frontal para armazenar dois sargentos.

Sistema de correia de gancho ajustável para maior conforto.

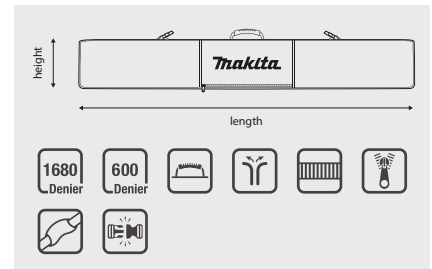

- 1 Bolsos interiores para imobilizar as guias de carril mais curtas.
- 2 Concebidas para armazenar duas guias de carril no seu interior.
- 3 Fecho de correr em todo o comprimento da capa para facilitar o armazenamento.
- 4 Fitas e correias ajustáveis para fixar as guias de carril.
- 5 Com forro de espuma para uma proteção adicional das guias.

Tamanho da guia de carril	Peso (Kg)	Capacidade (L)	Un.	Código	EAN	P.V.P (€)
1 m	1,11	-	1	E-05670	0088381567183	46,00
1,4/1,5 m	1,45	-	1	E-05664	0088381567176	53,00
1,9 m	-	-	1	E-10920	0088381581523	83,00
3 m	-	-	1	E-10936	0088381581530	103,00



Fita de velcro para fixação

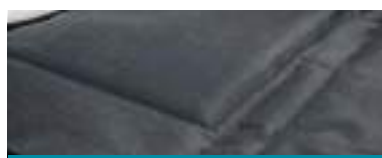

Material acolchoado para maior proteção das guias



Bolso exterior com fecho de correr

Joelheiras de alta proteção

- Joelheiras de alta proteção contra qualquer superfície.
- Não escorregam, marcam ou danificam as superfícies.
- Ideais para trabalhos em betão, pavimentos de madeira, trabalhos de construção civil ou qualquer outro trabalho relacionado.
- O desenho antiderrapante mantém as joelheiras no lugar.
- O acolchoamento de espuma de alta densidade proporciona o maior conforto possível.



As correias elásticas mantêm as joelheiras numa posição confortável durante todo o dia. Ideais para trabalhos em betão, pavimentos de madeira e trabalhos de construção.



- 1 A cobertura dura permite um uso prolongado ao ar livre
- 2 Cobertura especial para uma maior estabilidade do utilizador.
- 3 As correias elásticas adaptam-se à posição do seu corpo.
- 4 Tamanho único.

Medidas (C x L x A)	Peso (Kg)	Capacidade (L)	Un.	Código	EAN	P.V.P (€)
170 x 95 x 240 mm	0,52	-	1	E-05658	0088381567169	48,00



Joelheiras de alta proteção

Joelheiras flexíveis

- O material macio e antideslizante garante uma grande durabilidade.
- Protegem os joelhos.
- Não escorregam, marcam ou danificam as superfícies.
- As fitas flexíveis mantêm as joelheiras numa posição confortável durante todo o dia.
- Perfeitas para pavimentos e ladrilhos de todo o tipo, em garagens, jardins e estaleiros de construção.



As fitas flexíveis e elásticas mantêm os joelhos no seu lugar.

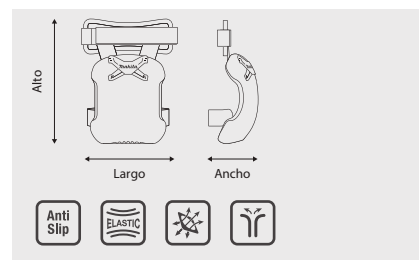

- 1 Fabricadas em material antiderrapante de qualidade superior.
- 2 Forro de malha respirável.
- 3 As fitas elásticas adaptam-se à posição do corpo.
- 4 Tamanho único.
- 5 Correias de banda elástica com gancho.

Medidas (C x L x A)	Peso (Kg)	Capacidade (L)	Un.	Código	EAN	P.V.P (€)
170 x 30 x 240 mm	0,28	-	1	E-05642	0088381567152	32,00



Joelheiras de proteção

Baterias, carregadores e compatibilidade de carregamento



Lítio-ion EXTREMA TECNOLOGIA

36V

Carregador rápido



BL3626 194873-2 DC36RA 194863-5

P.V.P
278 €

Tempo de
carregamento **22** min

P.V.P
184 €

36V

Carregador normal



BL3622A 195410-5 DC36WA 195471-5

P.V.P
190 €

Tempo de
carregamento **60** min

P.V.P
95 €

Ni - MH

24 V
Ni-MH

DC24SC
194164-1



167 €

3,1
Ah



268 €

BH2433
193739-3

60
min

MAKSTAR

12 V
Ni-MH

DC24SC
194164-1

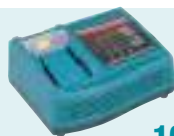

167 €

DC18RC
195584-2



112 €

DC18SD
194533-6



76 €

DC18SE
Automóvel 194622-7



113 €

3,1
Ah



BH1233C
193930-3

30
min

22
min

70
min

9,6 V
Ni-MH

DC24SC
194164-1

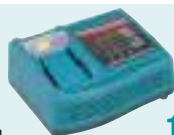

167 €

DC18RC
195584-2



112 €

DC18SD
194533-6



76 €

DC18SE
Automóvel 194622-7



113 €

3,1
Ah



144 €

BH9033C
193636-3

30
min

30
min

70
min

1,8
Ah



134 €

BH9020
193631-3

20
min

15
min

40
min

Ni - MH

18 V

DC1804
193827-6

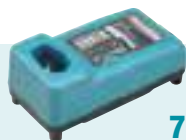

76 €

DC1822
Automóvel
193439-5

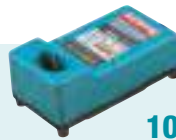

106 €

DC1414
193864-0

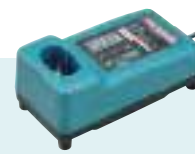

62 €

2,8
Ah



150 €

1835
193061-8

70
min

70
min

14,4 V

2,8
Ah



115 €

1435
193060-0

70
min

70
min

70
min

18 V

2,8
Ah



99 €

1235
193059-5

70
min

70
min

70
min

Malas



Malas empilháveis Makpac.

- Oferecemos uma vasta gama de produtos para transportar o seu equipamento de trabalho nas melhores condições. Além disso, poderá expandir os seus equipamentos de trabalho de forma sistemática.



Com o armazenamento MakPac, pode modificar as diferentes formas de armazenamento a qualquer momento, combiná-las separadamente e transportar seus dispositivos adicionais.

No seu armazém, as possibilidades são ilimitadas.

O número de malas que podem ser empilhadas, na verdade, é ilimitada.



- As pegas fortes e retráteis fazem com que o transporte e o armazenamento sejam feitos de forma correta.

Quatro tamanhos diferentes.

- Estão disponíveis quatro tamanhos diferentes de malas.
- Também pode optar por um plástico específico para armazenar a sua ferramenta corretamente.
- As malas MAKPAC são empilháveis, podem ser unidas ou separadas através dos quatro cliques de bloqueio manual.
- Uma vez unidas, podem ser levantadas com uma mão para o seu transporte.
- As pegas fortes e retráteis fazem com que o transporte e o armazenamento sejam feitos de forma correta.



Tipo 1



Tipo 2



Tipo 3



Tipo 4

Malas Makpac com gavetas

- Novas malas Makpac com gavetas para acessórios



P-84311



P-84333



P-84327

- Malas Makpac com gavetas, para maior comodidade e organização. Distribui facilmente parafusos, buchas e outros acessórios.
- Possibilidade de unir facilmente aos diferentes produtos Makpac.

Descrição	Un.	Código	EAN	P.V.P. (€)
4 gavetas. 295 x 395 x 210 mm	1	P-84311	0088381580786	182,00
6 gavetas. 295 x 395 x 210 mm	1	P-84333	0088381580809	208,00
12 gavetas. 295 x 395 x 210 mm	1	P-84327	0088381580793	216,00

Conjunto de divisórias para malas Makpac



Descrição	Un.	Código	EAN	P.V.P. (€)
Conjunto de divisórias	1	P-84171	-	14,40

Geleira Makpac

Ideal para manter as bebidas frias no local de trabalho!

- Com poliestireno de 20 mm de espessura e fitas de vedação na junta entre a tampa e a caixa.

18 L



500 mL x 20 2 L x 4

Dimensões	Mala	Un.	Código	EAN	P.V.P. (€)
295 x 395 x 315 mm	Tipo 4	1	198253-4	0088381476607	120,00

Carrinho de transporte



Descrição	Un.	Código	EAN	P.V.P. (€)
Carrinho de transporte Capacidade de carga até 100 kg	1	P-83886	0088381468411	120,00

Trolley com rodas



Mala Makpac não incluída

Descrição	Un.	Código	EAN	P.V.P. (€)
Trolley com rodas Capacidade de carga até 25 kg	1	TR00000001	0088381468190	213,00

Classificador interno de plástico



Mala Makpac não incluída

Descrição	Un.	Código	EAN	P.V.P. (€)
Classificador com compartimentos diferentes	1	P-83668	0088381463805	10,80

Classificador interno de plástico colorido

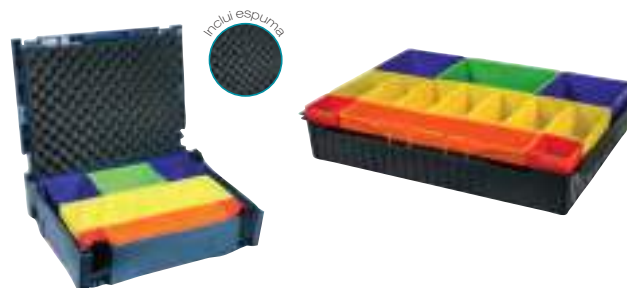

Mala Makpac não incluída

Descrição	Un.	Código	EAN	P.V.P. (€)
Classificador com compartimentos diferentes	1	P-83652	0088381463799	32,00

Separador de espuma

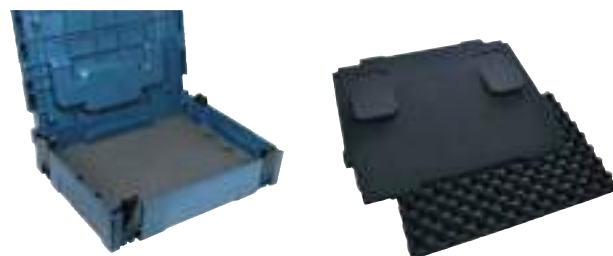

Mala Makpac não incluída

P-84268

Descrição	Un.	Código	EAN	P.V.P. (€)
Separador de espuma adequado para todas as malas Makpac	1	P-83705	0088381463843	22,00
Espuma universal de 20 mm Makpac	1	P-84268	-	16,65
Espuma universal de 40 mm Makpac	1	P-84274	-	19,25

Caixa de ferramentas Makpac



Descrição	Un.	Código	EAN	P.V.P. (€)
Caixa de ferramentas prática com vários compartimentos.	1	P-84137	0088381524865	89,00

Plásticos interiores e malas MAKPAC

Tipo 1



Medidas	Un.	Código	EAN	P.V.P. (€)
39,5 x 29,5 x 10,5 cm	1	821549-5	0088381432986	31,00

Tipo 2



Medidas	Un.	Código	EAN	P.V.P. (€)
39,5 x 29,5 x 15,5 cm	1	821550-0	0088381430128	34,00

PLÁSTICOS INTERIORES

Makpac	Modelo (ferramenta)	Un.	Código	EAN	P.V.P. (€)
821549-5	4326 4328 4326 4329 4350CT 4350FCT 4351FCT JV0600	1	837803-7	0088381436090	7,70
	DA330D	1	837695-4	0088381436083	9,55
	DF030D DF330D HP330D TD090D TW100D	1	837866-3	0088381525954	8,20
	DF031D DF032D DF033D DF331D DF332D DF333D HP331D HP332D HP333D TD110D TD111D	1	838312-9	0088381526166	6,55
	DP3002 DP3003 DP4001 DP4002 DP4003 DP4001 HP2051 HP2071	1	838039-1	0088381441452	8,15
	JR100D	1	837664-5	0088381436052	8,20
	6904V 6952 TW0200	1	837869-7	0088381525978	7,95
	HR1841	1	839214-2	-	5,20
	JV103	1	839186-1	0088381526234	5,15



PLÁSTICOS INTERIORES

Makpac	Modelo (ferramenta)	Un.	Código	EAN	P.V.P. (€)
821550-0	DBO180	1	837809-5	0088381437349	7,70
	DBS180	1	835P86-9	-	4,20
	DDA350	1	838040-6	0088381441704	7,35
	DDF343 DDF441 DDF446 DDF448 DDF451 DDF453 DDF456 DDF459 DDF480 DDF482 DDF484 DHP343 DHP441 DHP446 DHP448 DHP451 DHP453 DHP456 DHP459 DHP480 DHP481 DHP482 DHP484	1	837916-4	0088381441438	9,05
	DFS250 DFS251 DFS451 DFS452 FS2300 FS2500 FS2700 FS4200 FS6300	1	837805-3	0088381436250	7,70
	DGD800	1	837806-1	0088381436267	7,70
	DJV180 DJV182	1	837639-4	0088381436120	11,35
	DJS161	1	837636-0	0088381436113	7,10
	BO4900V BO4901	1	837675-0	0088381436212	8,40
	BST221 DPT351	1	837640-9	0088381436137	9,30
	DFN350	1	835B51-4	0088381568777	3,85
	DDF083 DDF483 DHP483 DTD129 DTD134 DTD146 DTD147 DTD148 DTD152 DTD153 DTD154 DTD155 DTD170 DTD171 DTP140 DTP141 DTW250 DTW251 DTW281 DTW285	1	837670-0	0088381436182	12,10
	DTW300 DTW301	1	835L10-8	-	
	DTL061	1	837644-1	0088381436144	8,45
	GA4540 GA4540C GA5040 GA5040C SA5040C	1	837672-6	0088381436199	4,35
	HR2300 HR2600 HR2610 HR2610T HR2611FT	1	837651-4	0088381436151	8,10
	HS300D	1	837662-9	0088381436175	15,20
	JN3201 JS3201	1	837630-2	0088381430142	8,45
	RP0900	1	837646-7	0088381525916	8,15
	RP0910 RP110C	1	837660-3	0088381436168	8,50
	TM3000C TM3010C	1	837673-4	0088381436205	8,15
	TW0350	1	837870-2	0088381525985	7,55
	TW004G TW005G	1	835R29-3	-	3,85
	BO5030 BO5031 BO5040 BO5041	1	837874-4	0088381526029	10,60
	6906	1	838024-4	-	10,55
	9046	1	838025-2	-	10,60
	3709 3710	1	837674-2	0088381525923	8,75
	HR166D	1	838683-4	-	6,20
	DJR183	1	837897-2	0088381447195	5,45
	HR140	1	839245-1	0088381526258	4,95
	DRV150Z	1	835A34-8	-	3,80

Plásticos interiores e malas MAKPAC

Tipo 3



Medidas	Un.	Código	EAN	P.V.P. (€)
39,5 x 29,5 x 21,5 cm	1	821551-8	0088381432993	37,00

Tipo 4



Medidas	Un.	Código	EAN	P.V.P. (€)
39,5 x 29,5 x 31,5 cm	1	821552-6	0088381433006	48,00

PLÁSTICOS INTERIORES

Makpac	Modelo (ferramenta)	Un.	Código	EAN	P.V.P. (€)
821551-8	9403	1	837652-2	0088381436359	8,25
	9404	1	837653-0	0088381436366	8,20
	9911 9910	1	837658-0	0088381436397	7,70
	BO6030	1	837654-8	0088381436373	8,70
	BO6040	1	837655-6	0088381436380	8,45
	DBN500	1	838023-6	0088381453967	7,35
	DSS501 DCS550	1	837628-9	0088381436274	8,50
	DFR550Z	1	837631-0	0088381447201	7,65
	DGA504 DGA508 DGA454 DGA458 DGA461 DGA467 DGA511 DGA517 DTD171 DTD171	1	838175-3	0088381453981	10,05
	DGA452	1	837632-8	0088381436281	8,15
	DHR165	1	838109-6	0088381453998	8,50
	DHR202	1	837634-4	0088381436304	9,00
	DHS680	1	838182-6	0088381454018	10,15
	DKP180	1	837808-7	0088381436434	7,70
	DPJ180	1	837648-3	0088381436342	7,70
	DSS610	1	837642-5	0088381436328	9,00
	DTM50 DTM51	1	837671-8	0088381436427	8,10
	DTW450 DTW1001 DTW1002	1	837645-9	0088381436335	8,25
	HP001G DF001G	1	835F93-2	-	2,95
	KP0800 KP0810 KP0810C	1	837659-8	0088381436403	7,70
	N9741	1	838026-0	-	8,75
	PJ7000	1	837661-1	0088381436410	11,45
	DHR171	1	839387-1	0088381535588	5,25
	DPT353	1	839128-5	0088381535601	8,45
	DLX2221	1	837864-7	0088381441216	5,45
	DJN161	1	837678-4	0088381436229	12,00
	DJR188	1	839458-4	0088381526319	7,30
	DJV181	1	837789-5	0088381441414	6,95
	BO6050J	1	838246-6	0088381526142	5,50
	DHS661Z	1	839752-4	-	5,15
	HS6601	1	838314-5	-	4,90
	DCS553	1	839751-6	0088381546492	4,90
TD001G	1	835F94-0	-	3,05	
TW001G TW007G TW008G	1	835K85-1	-	3,80	

PLÁSTICOS INTERIORES

Makpac	Modelo (ferramenta)	Un.	Código	EAN	P.V.P. (€)
821552-6	5008MG 5604R 5704R	1	837657-2	0088381436489	9,60
	CA5000	1	838390-9	0088381526197	9,90
	DHR242 DHR243	1	837649-1	0088381535595	8,20
	DHR262 DHR262T	1	837650-6	0088381436472	8,50
	DHR263 DHR264	1	837988-9	0088381454001	9,30
	DHS710	1	837861-3	0088381441445	17,45
	DHK180	1	835D35-4	0088381574501	4,35
	HS6101 HS7101	1	837807-9	0088381436502	8,00
	RP1800 RP2300FC	1	837647-5	0088381436465	8,20
	RT0700C	1	837247-1	0088381436441	8,20
	SP6000	1	837945-7	0088381437356	7,70
	SG1251	1	838111-9	0088381526135	8,25
	BO5030 BO5031 BO5040 BO5041	1	837247-1	0088381436441	8,20
	DHR280 DHR281 DHR282 DHR283	1	839559-8	0088381526333	4,30
	CC301	1	838315-3	0088381526180	6,80
	DHR182	1	839891-0	-	5,20
	DBN600	1	839523-9	-	4,35
	GA005G GA008G GA013G GA016G GA022G GA023G GA026G GA028G GA029G GA032G	1	835E79-0	-	3,00
	KITS DE BATERIAS 4,0 Ah 5,0 Ah 6,0 Ah	1	839205-3	0088381436342	5,20
	HR001G HR002G HR003G HR004G	1	835C84-5	-	3,00
	HS004G	1	835K82-7	-	3,80
	HS7601	1	838108-8	-	5,65

Fecho de mala Makpac



Descrição	Un.	Código	EAN	P.V.P. (€)
Fecho de mala Makpac	1	453974-8	0088381430135	0,60

Modelo	Descrição	Un.	Código	EAN	P.V.P. (€)
1100	Metálico	1	181790-5	008838118705	99,00
4326	Plástico	1	824572-9	0088381151627	11,85
4327	Plástico	1	824572-9	0088381151627	11,85
4328	Plástico	1	824572-9	0088381151627	11,85
4329	Plástico	1	824572-9	0088381151627	11,85
6807	Plástico	1	824890-5	3240890391902	15,45
6842	Plástico	1	824808-6	0088381347204	34,00
6844	Plástico	1	824808-6	0088381347204	34,00
2107F	Plástico	1	824728-4	0088381197700	45,00
2107FX	Plástico	1	824728-4	0088381197700	45,00
4350CT	Plástico	1	824809-4	0088381345729	23,00
4350T	Plástico	1	824809-4	0088381345729	23,00
4351CT	Plástico	1	824809-4	0088381345729	23,00
5603R	Plástico	1	824555-9	0088381189422	46,00
5604R	Plástico	1	824555-9	0088381189422	46,00
5903R	Plástico	1	193196-5	0088381189385	58,00
6019D	Plástico	1	824723-4	0088381200455	17,00
6096D	Plástico	1	824723-4	0088381200455	17,00
6207DW	Plástico	1	183763-4	0088381139595	23,00
6260D (3 baterias)	Plástico	1	824652-1	0088381196949	9,80
6260D (lanterna)	Plástico	1	824581-8	0088381156790	12,35
6261D (3 baterias)	Plástico	1	824852-3	0088381350631	14,15
6270D (3 baterias)	Plástico	1	824652-1	0088381196949	9,80
6270D (lanterna)	Plástico	1	824581-8	0088381156790	12,35
6271D (3 baterias)	Plástico	1	824852-3	0088381350631	14,15
6280D (3 baterias)	Plástico	1	824652-1	0088381196949	9,80
6280D (lanterna)	Plástico	1	824581-8	0088381156790	12,35
6281D (3 baterias)	Plástico	1	824852-3	0088381350631	14,15
6317D	Plástico	1	183763-4	0088381139595	23,00
6337D	Plástico	1	183763-4	0088381139595	23,00
6347D	Plástico	1	183763-4	0088381139595	23,00
6391D (3 baterias)	Plástico	1	824852-3	0088381350631	14,15
6904V	Plástico	1	824698-7	0088381183789	28,00
6905B	Plástico	1	824698-7	0088381183789	28,00
6905H	Plástico	1	824698-7	0088381183789	28,00
6918FD	Plástico	1	824635-1	0088381161145	10,85
6934FD	Plástico	1	824635-1	0088381161145	10,85
6935FD	Plástico	1	824635-1	0088381161145	10,85
6936FD	Plástico	1	824635-1	0088381161145	10,85
6980FD	Plástico	1	824635-1	0088381161145	10,85
8270D	Plástico	1	824635-1	0088381161145	10,85
8280D	Plástico	1	824635-1	0088381161145	10,85
9554NB	Metálico	1	823256-6	-	24,00
9555NB	Metálico	1	823256-6	-	24,00
9557NB	Metálico	1	823256-6	-	24,00
9558NB	Metálico	1	823256-6	-	24,00
AF505	Plástico	1	HY00000090	0088381335218	19,55
BFR440	Plástico	1	824756-9	0088381341981	22,00
BGA452	Plástico	1	824767-4	0088381289702	19,55
BHR162	Plástico	1	824863-8	0088381351010	53,00
BHR200SJEP	Plástico	1	824690-3	-	36,00
BHR202	Plástico	1	141642-2	-	24,00

Modelo	Descrição	Un.	Código	EAN	P.V.P. (€)
BJR181	Plástico	1	824760-8	0088381341998	23,00
BO4556	Plástico	1	824806-0	0088381346092	13,55
BO4565	Plástico	1	824806-0	0088381346092	13,55
BO5020	Plástico	1	183782-0	0088381189262	23,00
BO5021	Plástico	1	183782-0	0088381189262	23,00
BO5030	Plástico	1	183782-0	0088381189262	23,00
BO5031	Plástico	1	183782-0	0088381189262	23,00
BSS610	Plástico	1	824757-7	0088381252898	30,00
BTW200	Plástico	1	824593-1	0088381158084	35,00
BUC122	Plástico	1	824820-6	3240890258571	47,00
DA400LR	Plástico	1	824646-6	0088381171052	44,00
DBM080	Metálico	1	P-45135	0088381975247	47,00
DBN500	Metálico	1	821604-3	-	56,00
DF010D	Plástico	1	158775-6	3240890276278	11,55
DF030D	Plástico	1	824842-6	3240890276261	11,45
DF330D	Plástico	1	824842-6	3240890276261	11,45
DF347D	Plástico	1	824981-2	0088381401517	18,60
DF457D	Plástico	1	824981-2	0088381401517	18,60
DP4011	Plástico	1	824695-3	0088381184342	15,40
FS2300	Plástico	1	824890-5	3240890391902	15,45
FS2500	Plástico	1	824890-5	3240890391902	15,45
FS2700	Plástico	1	824890-5	3240890391902	15,45
FS4200	Plástico	1	824890-5	3240890391902	15,45
FS6300R	Plástico	1	824890-5	3240890391902	15,45
GA038G	Plástico	1	821841-9	-	52,00
GA7020R	Plástico	1	824958-7	0088381371438	29,00
GA7030R	Plástico	1	824958-7	0088381371438	29,00
GA7040R	Plástico	1	824958-7	0088381371438	29,00
GA9020R	Plástico	1	824958-7	0088381371438	29,00
GA9030R	Plástico	1	824958-7	0088381371438	29,00
GA9040R	Plástico	1	824958-7	0088381371438	29,00
GF600SE	-	-	824990-1	0088381425148	58,00
GN900SE	Plástico	1	824875-1	0088381354509	50,00
HG5002	Plástico	1	HG130442	3240890345578	22,00
HG5012	Plástico	1	HG130442	3240890345578	22,00
HG550V	Plástico	1	HG130442	3240890345578	22,00
HG551V	Plástico	1	HG130442	3240890345578	22,00
HG651C	Plástico	1	HG130442	3240890345578	22,00
HK0500	Plástico	1	824523-2	0088381151849	40,00
HK1810	Metálico	1	150640-5	0088381152426	35,00
HK1820	Plástico	1	824789-4	0088381346108	17,75
HM0860C	Plástico	1	824708-0	0088381187725	39,00
HM0870C	Plástico	1	824905-8	-	71,00
HM0871C	Plástico	1	824904-0	0088381361743	74,00
HM1101C	Plástico	1	140561-9	0088381367639	132,00
HM1111C	Plástico	1	140561-9	0088381367639	132,00
HM1200K	Plástico	1	150583-1	0088381152402	47,00
HM1202C	Plástico	1	824564-8	0088381154536	69,00
HM1203C	Plástico	1	824908-2	0088381359504	102,00
HM1213C	Plástico	1	824908-2	0088381359504	102,00
HM1214C	Plástico	1	824882-4	0088381359788	146,00
HM1303	Metálico	1	182851-4	0088381155618	148,00

Modelo	Descrição	Un.	Código	EAN	P.V.P. (€)
HM1304B	Metálico	1	183598-3	0088381183796	105,00
HM1307C	Plástico	1	824898-9	-	142,00
HM1317C	Plástico	1	824898-9	-	142,00
HM1317CB	Plástico	1	824898-9	-	142,00
HP1620	Plástico	1	824724-2	0088381193887	18,00
HP1621	Plástico	1	824724-2	0088381193887	18,00
HP1631	Plástico	1	824811-7	0088381351140	17,80
HP1640	Plástico	1	824811-7	0088381351140	17,80
HP1641	Plástico	1	824811-7	0088381351140	17,80
HP2050	Plástico	1	824695-3	3240890275165	15,40
HP2051	Plástico	1	824695-3	3240890275165	15,40
HP2070	Plástico	1	824695-3	3240890275165	15,40
HP2071	Plástico	1	824695-3	3240890275165	15,40
HP330D	Plástico	1	824842-6	3240890276261	11,45
HP347D	Plástico	1	824981-2	0088381401517	18,60
HP457D	Plástico	1	824981-2	0088381401517	18,60
HR005G	Plástico	1	821837-0	-	43,00
HR160D	Plástico	1	824550-9	0088381157612	20,10
HR1830	Plástico	1	824695-3	3240890275165	15,40
HR2020	Plástico	1	824695-3	3240890275165	15,40
HR2230	Plástico	1	824799-1	0088381346849	25,00
HR2440	Plástico	1	824695-3	3240890275165	15,40
HR2450	Plástico	1	824695-3	3240890275165	15,40
HR2460	Plástico	1	824799-1	0088381346849	25,00
HR2470	Plástico	1	824799-1	0088381346849	25,00
HR2800	Plástico	1	824789-4	0088381346108	17,75
HR2810	Plástico	1	824789-4	0088381346108	17,75
HR2811	Plástico	1	824789-4	0088381346108	17,75
HR3200C	Plástico	1	824819-1	3240890266422	55,00
HR3210C	Plástico	1	824825-6	0088381349727	64,00
HR3540C	Plástico	1	824819-1	3240890266422	55,00
HR3541FC	Plástico	1	824825-6	0088381349727	64,00
HR4013C	Plástico	1	196278-2	0088381462976	98,00
HR4500C	Plástico	1	824607-6	0088381160070	63,00
HR4501C	Plástico	1	158274-8	0088381369510	76,00
HR5000	Plástico	1	150589-9	0088381146661	58,00
HR5001C	Plástico	1	824519-3	0088381152952	64,00
HR5201C	Plástico	1	158274-8	3240890306630	76,00
JR001G	Plástico	1	821796-8	0088381579797	37,00
JR3060T	Plástico	1	821621-3	-	23,00
JR3070CT	Plástico	1	821621-3	-	23,00
JV0600K	Plástico	1	824998-5	0088381401487	21,00
KP0800	Plástico	1	824892-1	0088381361408	15,40
PC1100	Metálico	1	181789-0	0088381116213	70,00
PC5001C	Metálico	1	140073-2	0088381358651	72,00
SG150	Metálico	1	B50856	3240890267061	64,00
TD090D	Plástico	1	824842-6	3240890276261	11,45
TW0200	Plástico	1	824703-0	0088381185424	15,10
TW0350	Plástico	1	824702-2	0088381185837	20,05
TW1000	Plástico	1	824737-3	0088381200042	56,00
UC120DWAE	Plástico	1	824491-9	0088381152747	37,00
JV101	Plástico	1	821691-2	-	21,00

Modelo	Descrição	Un.	Código	EAN	P.V.P. (€)
HR4001	Plástico	1	196183-3	-	93,00
HR4011C	Plástico	1	196185-9	-	99,00
DTM51	Plástico	1	821608-5	-	23,00
BHP458	Plástico	1	143603-8	-	36,00
HS7101	Plástico	1	141736-3	-	57,00
TD110D	Plástico	1	821661-1	-	16,70
DJR187	Plástico	1	821620-5	0088381572385	29,00
DJR181	Plástico	1	141354-7	-	29,00
HS301D	Plástico	1	821663-7	-	21,00
DCG180	Plástico	1	821568-1	0088381437516	63,00
DGA900	Plástico	1	821717-0	0088381536172	58,00
DGA511	Plástico	1	821734-0	-	36,00
CG100	Plástico	1	821710-4	0088381585927	32,00
DJR360	Plástico	1	821670-0	0088381524209	51,00
9069K1	Plástico	1	824707-2	-	15,45
BHR242	Plástico	1	141401-4	0088381432764	30,00

Escovas (por modelos de máquina)

1		6319D		BPJ180		DTW450	441	HP1631K	419	LF1016F	
1100	100	6337D		BSS501	430	F		HP2010N	106	LH1040F	153
1902	51	6339D	430	BSS610	441	FS2300		HP2033		LH200FL	
1806B	153	6347D		BTD130F		FS2500		HP2050		LS0714F	303
1902K		6349D		BTD140	440	FS2700	419	HP2051		LS0815FL	JM23500117
1923B	51	6501X	70	BTD200	441	FS4200		HP2070	419	LS1013F	
1923H	132	6797F	424	BTP130		FS6300R		HP2071		LS1013FL	
2		6805BV	64	BTP140	440	G		HR1830		LS1013L	
2012NB	153	6824N		BTS130	440	GA4530		HR2020		LS1016FL	
2107FK		6825R	419	BTW200	441	GA5030	459	HR2230	325	LS1018L	
2107FKK	303	6826N		BTW250		GA4534		HR2300		LS1040F	153
2414B		6904V	415	BTV251	440	GA5034		HR2410		LS1214F	
2414EN	203	6905B	65	BTW450	441	GA4540C	318*	HR2432		LS1214L	
2414NB		6905H	415	BUC122	430	GA4540Z	325	HR2440	419	LS1216F	
2704	153	6918FD		D		GA5021C	253	HR2450		LS1216FL	
3		6932FD		DA3000R	65	GA5040C	318*	HR2450T		LS1440	
3612	203	6934FD		DA3010F	419	GA5040Z	325	HR2460		M	
3620	106	6935FD	434	DA3011F		GA6021C	253	HR2460F		MLS100	JM23000123
3706	64	6936FD		DA4000LR	303	GA6040C	318*	HR2470	325	MLT100	
3709		6980FD		DA4031		GA7010C	204*	HR2470F		N	
3710	411	7		DA6301	100	GA7012C		HR2470FT		N4105KB	
3901		7104L	153	DBM130		GA7020S		HR2475T	105*	N9741	100
3601B	153	8		DBM131	EE80700019	GA7020R		HR2600		NPC1100	
3612C	203	8414D		DBM230		GA7030S		HR2610		P	
3707FC	411	8434D	430	DCS550	430	GA7030R		HR2610T	325	PC5001C	253
4		8444D		DDA340		GA7040S		HR2611FT		PJ7000C	459
440	80051B5X	9		DDF440		GA7040R		HR262D	442	PV7000C	303
443	W26774	906	64	DDF441		GA7050		HR2622D		PW5000CH	318*
445X	80051B5X	9031		DDF442		GA7050R		HR2800			
446L		9032	411	DDF450		GA9010C	204*	HR2810		RP0900	106
447L	W49625	9046	419	DDF451		GA9012C		HR2810T	325	RP0910	
4131	303	9402	153	DDF452		GA9020S		HR2811FT		RP1100C	303
4326		9403		DDF458	440	GA9020R		HR3000C	327*	RP1800	
4327	64	9404	303	DFR440		GA9030S		HR3200C		RP2300FC	203
4328		9903		DFR550		GA9030R		HR3210C		RT0700C	411
4329		9910	411	DFR750		GA9040S		HR3210FCT	350*	S	
4402		9911		DFS440		GA9040R		HR3540C		SA5040C	318*
4403	411	9920		DFS450		GA9050		HR3541FC		SA7000C	204*
4101RH	303	9015B	303	DFS451		GA9050R		HR4000C	327*	SC161D	430
4112HS	204*	9016B		DGA452	430	GD0600		HR4001C		SG1250	
4114S		9049S		DGD800		GD0601	325	HR4003C		SG1251J	318*
4157KB	153	9059S	204*	DHP440		GD0602		HR4011C	350*	SG150	B45872
4329K	64	9077S		DHP441		GD0800C		HR4013C		SL7000	MO1401045
4331D		9079S		DHP442		GD0801C	318*	HR4500C	155*	SP6000	303
4333D	430	9218SB	100	DHP450	440	GD0810C		HR4501C		SR2300	155*
4334D	441	9227CB	303	DHP451		GD0811C		HR4511C	171	T	
4340CT		9554NB		DHP452		GS5000	204*	HR5000	155*	TD0101F	411
4350CT		9555NB		DHP458		GS6000		HR5001C		TM3000C	
4350FCT		9557NB	325	DHP460		GV5010	64	HR5201C	171	TM3010C	459
4350T	419	9558NB		DHR162	430	GV7000C	303	HR5202C	175	TW0200	
4351CT		9558PBY		DHR200		H		HR5211C	171	TW0350	411
4351FCT		9561CH		DHR202	441	HB500	EIB106C	HR5212C	175	TW1000	153
5		9562C		DHR261		HK0500	113	HS6100		U	
5008MG	153	9562CH	318*	DHR262	442	HK1810	105*	HS7100	174	UB1101	303
5017RKB	303	9562CVH		DJN161	430	HK1820	350*	HS7101		UC3530A	957805410
5103R		9564C		DJR181		HM0810B		J		UC4020A	132
5104S	203	9564H	325	DJR182	441	HM0810T	105*	JN1601	411	UC4030A	957805410
5143R		9565HP	318*	DJR240		HM0830T		JN3200	100	UT120	EE80700013
5603R		9565CVL		DJV140	430	HM0860C	327*	JN3201	303	UT121	EE80700032
5604R	303	9565H	325	DJV180		HM0870C		JR1000FT	419	SG150	B45872
5704R		9565PCV		DDF446		HM0871C	350*	JR140D	441	SP6000	303
5705R		9566C		DDF458	440	HM1101C		JR180D		SR2300	155*
5903R	203	9566HP	318*	DFS451		HM1111C	171	JR3050T		T	
6		9566PCV		DGA452	430	HM1200B		JR3060T	303	TM3000C	
6305	303	9924DB	100	DHP456	440	HM1200K	155*	JR3070CT		TM3010C	459
6310		E		DHP458		HM1202C		JS1000	459	TW0200	
6408	419	BLS820	441	DHR202	441	HM1203C		JS1600	65	TW0350	411
6413	64	BO3700	64	DJR181		HM1213C	171	JS1601		TW1000	153
6501	70	BO4556		DJV180	430	HM1214C		JS1602	459	U	
6807		BO4557		DP2010		HM1304	204*	JS1660		UB1101	303
6821		BO4565	419	DP2011		HM1304B		JS1670	65	UC3530A	957805410
6823		BO4566		DP3002		HM1307C		JS3200	100	UC4020A	132
6824	419	BO4900V		DP3003		HM1317C	171	JS3201	303	UC4030A	
6826		BO4901		DP4000	419	HM1317CB		JS8000	419	UH5540	957805410
6827		BO5010		DP4001		HM1400	155*	JV0600	64	UH6540	
6842		BO5020	64	DP4002		HM1801		K		UT120	EE80700013
6844	411	BO5021		DP4003		HM1810	204*	KP0800	411	UT1200	EE80700032
6906	100	BO5030	419	DP4011		HP1620		KP0810	132		
6952	411	BO5031		DS4012	411	HP1621	419	KP0810C			
6013B		BO5040		DP4700	64	HP1631	85	KP312S	203		
6300-4	51	BO5041	64	DS4010	411	HP1640		L			
6305W	303	BO6030	419	DTD146	440	HP1641	419	LC1230	203		
6317D	430	BO6040	318*	DTW251		HP1641K		LF1000	153		

Escovas (por modelo de escova)

51	1902	155*	HM1200B	303	4101RH	325	HR2810T	419	DP4003	440	DFR750
	1902K		HM1200K		5017RKB		HR2811FT		DP4011		DFS440
	1923B		HM1202C		5603R		HM0830T		FS2300		DFS450
	6013B		HM1400		5604R		HM0860C		FS2500		DFS451
	6300-4		HR4500C		5704R		HR3000C		FS2700		DHP440
64	3706	171	HR5000	303	5705R	350*	HR4000C	419	FS4200	440	DHP441
	4326		HR5001C		6305		HK1820		FS6300R		DHP442
	4327		SR2300		6305W		HM0870C		HP1620		DHP450
	4328		HM1101C		9403		HM0871C		HP1621		DHP451
	4329		HM1111C		9404		HR3200C		HP1640		DHP452
	4329K		HM1203C		9903		HR3210C		HP1641		DHP458
	6413		HM1213C		9920		HR3210FCT		HP1641K		DDF446
	6805BV		HM1214C		9015B		HR3540C		HP1631K		DDF458
	906		HM1307C		9016B		HR3541FC		HP2033		DFS451
	BO3700		HM1317C		9227CB		HR4001C		HP2050		DHP456
	BO5010	HM1317CB	DA4000LR	HR4003C	HP2051	DHP458					
	BO5020	HR4501C	DA4031	HR4011C	HP2070	DTD146					
	BO5021	HR4511C	GV7000C	HR4013C	HP2071	DTW251					
	BO5040	HR5201C	JN3201		HR1830	4334D					
	BO5041	HR5211C	JR3050T		HR2020	BLS820					
DP4700	HS6100	JR3060T		HR2410	BSS610						
GV5010	HS7100	JR3070CT		HR2432	BTD200						
JV0600	HS7101	JS3201		HR2440	BTW200						
65	6905B	174	HR5202C	303	LS0714F	411	HR2450	424	HR2450T	441	BTW450
	DA3000R		HR5212C		PV7000C		HR2450T		DHR202		
	JS1600	2414B	RP0910		6844		JR1000FT		DJR181		
	JS1660	2414EN	RP1100C		6952		JS8000		DJR182		
	JS1670	2414NB	SP6000		9031		6797F		DJR240		
70	6501	203	3612	303	UB1101	411	4331D	424	4331D	442	DHR202
	6501X		3612C		9561CH		9910		4333D		DJR181
	HP1631		5103R		9562C		9911		6317D		DTW450
	1100		5104S		9562CH		DS4012		6319D		JR140D
	6906		5143R		9562CVH		DS4010		6337D		JR180D
100	9218SB	203	5903R	303	9564C	415	6339D	430	6339D	442	DHR261
	9924DB		KP312S		9565HP		JN1601		6347D		DHR262
	DA6301		LC1230		9565CVL		KP0800		6349D		HR262D
	JN3200		RP1800		9565PCV		RT0700C		8414D		HR262TD
	JS3200		RP2300FC		9566C		TD0101F		8434D		GA4530
	N4105KB		4112HS		9566HP		TW0200		8444D		GA5030
	N9741		4114S		9566PCV		TW0350		8444D		GA4534
	NPC1100		9049S		B06040		6904V		BPJ180		GA5034
	HK1810		9059S		GA4540C		6905H		BSS501		JS1000
	HM0810B		9077S		GA5040C		4340CT		BUC122		JS1601
HM0810T	9079S	GA6040C	4350CT	DCSS50	JS1602						
105*	HR2510	203	GA7010C	303	GA6040C	415	4350FCT	430	DGA452	459	PJ7000C
	3620		GD0800C		GD0801C		4350T		DGD800		TM3000C
	HP2010N		GD0810C		GD0810C		4351CT		DHP460		TM3010C
106	RP0900	203	GA7020R	303	GD0811C	415	4351FCT	430	DHR162	459	UC3530A
	GA7030S		PW5000CH		6310		DHR200		UC4030A		
	GA7030R		SA5040C		6408		DJN161				
113	HK0500	204*	GA7040S	303	SG1250	419	6807	434	DJV140	440	440
	1923H		GA7040R		SG1251J		6821		DJV180		445X
	KP0810		GA7050		9554NB		6823		DGA452		SG150
	KP0810C		GA7050R		9555NB		6824		DJV180		UT120
	UC4020A		GA9010C		9557NB		6826		SC161D		DBM130
153	1806B	204*	GA9012C	325	9558NB	419	6827	434	6918FD	440	DBM131
	2012NB		GA9020S		9558PB		6824N		6932FD		DBM230
	2704		GA9020R		9564H		6825R		6934FD		UT121
	3601B		GA9030S		9565H		6826N		6935FD		UT1200
	4157KB		GA9030R		9565H		9046		6936FD		HB500
	4578MG		GA9030R		GA4540Z		BO4556		6980FD		MLS100
	5008MG		GA9040S		GA5040Z		BO4557		BTD130F		MLT100
	7104L		GA9040R		GD0600		BO4565		BTD140		LS0815FL
	9402		GA9050R		GD0601		BO4566		BTP130		SL7000
	LF1000		GS5000		HR2230		BO4900V		BTP140		
	LF1016F	GS6000	HR2300		BO4901V		BTS130				
	LH1040F	HM1304	HR2460		BO5030		BTW250				
	LH1200FL	HM1304B	HR2470		BO5031		BTW251				
	LS1013F	HM1801	HR2470F		BO6030		DDA340				
	LS1013FL	SA7000C	HR2470FT		DA3010F		DDF440				
	LS1013L	GA5021C	HR2600		DA3011F		DDF442				
	LS1016FL	GA6021C	HR2610		DP2010		DDF450				
	LS1018L	PC5001C	HR2610T		DP2011		DDF451				
	LS1040F	2107FK	HR2611FT		DP3002		DDF452				
	LS1214F	2107FKX	HR2800		DP3003		DDF458				
LS1214L	4131	HR2810	DP4000	DDF458							
LS1216F			DP4001	DFR440							
LS1216FL			DP4002	DFR550							
LS1440											
TW1000											

Nome	Código	P.V.P. (€)	Nome	Código	P.V.P. (€)	Nome	Código	P.V.P. (€)	Nome	Código	P.V.P. (€)	Nome	Código	P.V.P. (€)
CB-51	181021-2	1,50	CB-113	191904-8	5,50	CB-303	191963-2	3,00	CB-424	191966-6	1,90	957800410	957800410	6,75
CB-64	191627-8	1,50	CB-132	191972-1	3,60	CB-318*	191978-9	8,00	CB-432	191976-3	3,60	957802410	957802410	6,50
CB-65	191628-6	3,00	CB-153	181044-0	3,00	CB-325	194074-2	1,40	CB-434	191971-3	2,40	B45872	B45872	8,00
CB-70	191914-5	2,40	CB-155*	181048-2	7,00	CB-327*	194285-9	4,25	CB-436	193466-2	2,25	EE80700013	EE80700013	6,20
CB-85	191998-3	1,50	CB-171	195844-2	3,60	CB-350*	194160-9	3,60	CB-440	194427-5	3,00	EE80700019	EE80700019	6,20
CB-100	181030-1	2,40	CB-203	191953-5	3,00	CB-411	191940-4	2,00	CB-441	194435-6	3,60	JM23000123	JM23000123	3,00
CB-105*	181038-5	5,50	CB-204*	191957-7	3,00	CB-415	191950-1	4,80	CB-459	194722-3	1,90	W49625	W49625	25,00
CB-106	181410-1	2,75	CB-253	194547-5	4,20	CB-419	191962-4	1,75	80051B5X	80051B5X	12,00			

* Autodesconectantes.

Kits de manutenção para martelos



Modelos	Un.	Código	EAN	P.V.P. (€)
DHR162	1	188580-7	0088381350662	8,00
DHR200	1	195258-5	-	13,00
DHR202	1	195193-7	-	7,00
DHR242 DHR281 DHR282	1	195833-7	-	8,50
DHR243	1	195834-5	-	9,00
BHR261 BHR262 DHR263 DHR264	1	195189-8	-	12,00
HK0500	1	193397-5	-	17,00
HK1810	1	193394-1	-	13,00
HK1820	1	195194-5	-	17,00
HM0810 HM0810T	1	193242-4	-	28,00
HM0830T	1	188048-3	-	19,00
HM0860C	1	195204-8	-	31,00
HM0870C HM0871C	1	195113-1	-	28,00
HM1100 HM1100C	1	193243-2	-	21,00
HM1101C HM1111C	1	195260-8	-	32,00
HM1200 HM1200B	1	193244-0	-	37,00
HM1200K	1	193279-1	-	34,00
HM1202C	1	193391-7	0088381162326	28,00
HM1203C HM1213C HM1214C	1	195114-9	-	34,00
HM1303 HM1303B	1	193393-3	0088381162166	25,00
HM1304 HM1304B	1	195201-4	-	28,00
HM1307C HM1307CB HM1317C	1	195103-4	-	17,00
HM1400	1	193399-1	0088381162210	48,00
HM1801 HM1810	1	195205-6	-	34,00
HM1812	1	197127-6	-	31,00
HR1830	1	188389-7	-	10,00
HR2010	1	193395-9	-	13,00

Modelos	Un.	Código	EAN	P.V.P. (€)
HR2020 HR2021 HR2432 HR2440 HR2450 HR2450T HR2450FT	1	193606-2	-	17,00
HR2300 HR2600 HR2610	1	195105-0	-	15,00
HR2400	1	193386-0	-	14,00
HR2410 HR2430 HR2431	1	193388-6	-	12,00
HR2230 HR2460 HR2470/T HR2800 HR2810/T HR2811FT	1	195206-4	-	11,00
HR2510	1	193404-4	-	13,00
HR2630	1	196968-7	-	11,00
HR3000C	1	193390-9	0088381162159	21,00
HR3200C HR3210C HR3210FCT	1	195199-5	-	17,00
HR3520 HR3520T	1	193280-6	-	28,00
HR3540C	1	188646-3	-	11,00
HR3850 HR3850B	1	193281-4	-	31,00
HR3850K	1	193282-2	-	37,00
HR4000C	1	193283-0	-	23,00
HR4001C HR4011C	1	195195-3	-	23,00
HR4003C HR4013C	1	196532-4	-	24,00
HR4500C	1	193407-8	0088381162289	23,00
HR4501C HR4511C	1	195210-3	-	25,00
HR5000	1	193284-8	-	21,00
HR5000K	1	193285-6	-	28,00
HR5001C	1	193392-5	0088381163323	28,00
HR5201C HR5211C	1	195191-1	-	25,00
HR5202C HR5212C	1	196865-7	-	34,00



Código	Pág.	P.V.P. (€)
A		
A-07157	67	93,00
A-15051	298	22,00
A-16564	258	366,00
A-16570	258	364,00
A-16586	258	384,00
A-16592	258	430,00
A-16601	258	493,00
A-16617	258	757,00
A-19875	61	83,00
A-19897	61	40,00
A-31485	65	115,00
A-34235	281	35,00
A-34447	181	21,00
A-34453	181	21,00
A-34469	181	19,05
A-34475	181	16,50
A-34481	181	16,50
A-34534	181	20,10
A-34540	181	19,05
A-34556	181	18,00
A-34562	181	23,00
A-34578	181	23,00
A-34584	181	22,00
A-34590	181	22,00
A-34609	181	19,05
A-36706*	102	370,00
A-43692	101	13,45
A-43751	101	26,00
A-47450	222	102,00
A-47846	281	32,00
A-68161	59	80,00
A-80391	243	10,50
A-80400	244	9,95
A-80416	246	16,50
A-83951	298	26,00
A-85248	169	8,75
A-85400	136	10,30
A-85494	123	9,80
A-85503	123	19,55
A-85519	123	10,30
A-85525	123	19,55
A-85531	123	10,30
A-85547	123	19,55
A-85553	123	10,30
A-85569	123	19,55
A-85575	123	10,30
A-85581	123	18,55
A-85628	244	6,20
A-85634	244	6,50
A-85640	244	5,20
A-85656	242	4,20
A-85662	242	3,90
A-85678	242	3,90
A-85684	243	5,65
A-85690	243	5,80
A-85709	242	4,45
A-85715	243	5,50
A-85721	246	8,45
A-85737	245	5,25
A-85743	245	5,00
A-85759	245	5,00
A-85765	244	5,25
A-85771	244	5,85
A-85787	245	6,35
A-85793	244	4,45
A-85802	249	5,55
A-85818	248	7,30
A-85852	248	5,55
A-85868	248	4,45
A-85874	248	5,55
A-85880	249	5,80
A-85896	249	9,00
A-85905	249	6,05
A-85911	248	5,55
A-85927	248	7,05
A-85933	248	4,45
A-86169	214	45,00
A-86290	244	11,55
A-86309	243	8,05
A-86315	243	11,00
A-86468	214	69,00
A-86561	245	6,90
A-86583	244	7,30
A-86664	320	46,00
A-87579	218	237,00
A-89931	123	4,10
B		
B45872	385	8,40
B50856	383	64,00
B-8539	294	49,00
B-00898	101	49,00
B-00907	101	51,00

Código	Pág.	P.V.P. (€)
B-00913	101	51,00
B-00929	101	51,00
B-00935	101	51,00
B-00941	101	51,00
B-00957	101	52,00
B-00979	101	54,00
B-00985	101	63,00
B-00991	101	63,00
B-01002	101	74,00
B-01018	101	75,00
B-01024	101	82,00
B-01030	101	91,00
B-01046	101	94,00
B-01068	101	134,00
B-01127	101	236,00
B-01177	101	9,80
B-01183	101	10,30
B-01199	101	11,85
B-01208	101	14,40
B-01971	314	2,30
B-02870	136	36,00
B-05016	320	32,00
B-05038	230	16,50
B-05044	230	14,40
B-05072	216	43,00
B-05153	230	14,95
B-05169	228	12,90
B-05175	231	14,95
B-06292	242	6,35
B-06432	145	21,00
B-06460	242	8,00
B-06476	242	8,00
B-06482	242	9,55
B-06890	246	24,00
B-06909	246	33,00
B-06921	68	13,40
B-07004	68	16,75
B-07010	68	19,05
B-07250	233	30,00
B-07325	218	44,00
B-07375	314	3,10
B-07674	247	99,00
B-07680	247	104,00
B-07705	247	68,00
B-07711	247	88,00
B-07733	247	84,00
B-08187	206	18,55
B-08327	206	23,00
B-08757	213	45,00
B-08953	214	33,00
B-09042	214	33,00
B-09363	207	25,00
B-09737	216	101,00
B-10300	65	99,00
B-10344	212	60,00
B-10366	60	12,35
B-10394	233	34,00
B-10403	233	47,00
B-10506	123	4,90
B-10609	233	9,55
B-10615	218	44,00
B-10643	211	24,00
B-10970	243	12,70
B-10986	243	14,85
B-10372*	66	32,00
B-10388*	65	35,00
B-10665-5	157	21,00
B-11265*	100	8,00
B-12289	148	210,00
B-12295	148	103,00
B-12712	141	138,00
B-12762	142	45,00
B-12778	142	46,00
B-12784	142	104,00
B-12809	233	26,00
B-12980	143	41,00
B-12996	143	46,00
B-13007	143	56,00
B-13035	143	91,00
B-13041	143	168,00
B-13057	143	220,00
B-13063	143	71,00
B-13085	143	27,00
B-13091	143	29,00
B-13172	143	54,00
B-13188	143	55,00
B-13194	143	74,00
B-13219	143	144,00
B-13225	143	263,00
B-13253	144	96,00
B-13269	144	173,00
B-13275	144	202,00
B-13459	141	200,00

Código	Pág.	P.V.P. (€)
B-13465	141	258,00
B-13471	141	308,00
B-13546	142	155,00
B-13552	142	184,00
B-13568	142	222,00
B-13699	210	32,00
B-14118	310	11,35
B-14124	310	11,85
B-14130	310	11,85
B-14146	310	13,40
B-14152	310	13,40
B-14168	310	14,95
B-14607	211	9,55
B-16667	235	56,00
B-16673	235	47,00
B-16689	235	46,00
B-16695	235	62,00
B-16776	228	16,50
B-16782	228	16,50
B-16798	229	9,00
B-16807	229	9,00
B-16813	230	9,00
B-16829	229	14,95
B-16835	228	11,85
B-16841	228	11,85
B-16857	227	20,10
B-16863	229	19,05
B-20395	234	11,35
B-20404	234	11,35
B-20410	234	11,35
B-20426	234	11,35
B-20432	234	11,35
B-20448	234	11,35
B-20454	234	11,35
B-20644	258	24,00
B-21098	147	35,00
B-21559	197	4,10
B-21618	197	3,90
B-21624	197	3,60
B-21630	197	3,35
B-21646	197	3,35
B-21652	197	3,35
B-21668	197	3,35
B-21674	197	4,10
B-21680	197	3,85
B-21696	197	3,85
B-21705	197	3,85
B-21711	197	3,85
B-21727	197	3,85
B-21733	197	4,10
B-21749	197	3,85
B-21755	197	3,85
B-21761	197	3,85
B-21777	197	3,60
B-21783	197	3,60
B-21799	197	3,10
B-21808	197	3,10
B-21814	197	3,10
B-21820	197	3,10
B-21951	147	37,00
B-22028	147	94,00
B-22947	197	3,35
B-22953	197	3,35
B-22969	197	3,85
B-23064	60	19,60
B-23086	218	73,00
B-24876	118	27,00
B-24882	118	27,00
B-26490	118	26,00
B-26509	118	26,00
B-27246	210	28,00
B-28606	119	22,00
B-28662	157	57,00
B-28678	157	57,00
B-28684	157	72,00
B-28690	157	72,00
B-28977	160	9,55
B-28983	160	10,55
B-29072	115	6,80
B-29094	115	8,50
B-29496	216	95,00
B-30564	233	22,00
B-31706	100	8,00
B-31843	232	12,90
B-31859	232	17,50
B-31930	208	14,70
B-32007	208	17,90
B-32035	208	21,00
B-32085	208	32,00
B-32091	206	18,45
B-32100	206	22,00
B-32122	206	21,00
B-32144	206	23,00

Código	Pág.	P.V.P. (€)
B-32150	206	23,00
B-32172	206	37,00
B-32188	206	52,00
B-32203	206	22,00
B-32225	206	23,00
B-32247	206	24,00
B-32253	206	29,00
B-32269	206	24,00
B-32281	206	59,00
B-32297	206	27,00
B-32312	206	25,00
B-32340	206	32,00
B-32356	206	34,00
B-32362	206	30,00
B-32378	206	43,00
B-32384	206	63,00
B-32390	206	35,00
B-32409	206	47,00
B-32415	206	32,00
B-32568	213	73,00
B-32708	214	23,00
B-32720	214	52,00
B-32764	214	41,00
B-32770	214	37,00
B-32786	214	48,00
B-32792	214	38,00
B-32801	214	45,00
B-32817	214	63,00
B-32845	214	48,00
B-32851	214	75,00
B-32873	214	50,00
B-32889	214	82,00
B-32910	211	23,00
B-32926	211	21,00
B-32954	211	25,00
B-32976	211	24,00
B-32982	212	29,00
B-32998	212	35,00
B-33015	212	53,00
B-33021	212	57,00
B-33037	207	26,00
B-33043	207	21,00
B-33059	207	21,00
B-33087	207	81,00
B-33093	207	30,00
B-33118	207	29,00
B-33130	207	31,00
B-33146	207	60,00
B-33168	207	34,00
B-33174	207	27,00
B-33180	207	38,00
B-33196	207	48,00
B-33205	207	74,00
B-33211	207	75,00
B-33227	207	107,00
B-33233	210	39,00
B-33261	210	55,00
B-33277	210	63,00
B-33283	215	41,00
B-33299	215	48,00
B-33308	214	42,00
B-33314	215	68,00
B-33320	215	63,00
B-33336	215	70,00
B-33342	215	66,00
B-33358	215	92,00
B-33386	216	71,00
B-33392	216	77,00
B-33417	218	65,00
B-33423	218	47,00
B-33439	218	115,00
B-33445	218	53,00
B-33451	218	52,00
B-33467	218	139,00
B-33548	210	55,00
B-33554	210	26,00
B-33582	211	87

Código	Pág.	P.V.P. (€)
B-47438	46	2,85
B-47444	46	3,15
B-47450	46	4,70
B-47472	46	4,15
B-47488	46	5,20
B-47503	46	9,85
B-47525	46	14,55
B-47531	46	3,90
B-47547	46	5,20
B-47553	46	4,40
B-47569	46	4,90
B-47575	46	5,70
B-47581	46	6,50
B-47606	46	10,90
B-47612	46	15,05
B-47634	46	38,00
B-47640	46	5,45
B-47656	46	6,00
B-47662	46	7,25
B-47684	46	5,45
B-47690	46	6,75
B-47709	46	8,60
B-47721	46	11,95
B-47737	46	15,60
B-47759	46	41,00
B-47765	46	5,45
B-47771	46	6,25
B-47787	46	7,25
B-47793	46	9,35
B-47802	46	6,75
B-47818	46	8,35
B-47824	46	9,35
B-47830	46	14,55
B-47846	46	17,15
B-47852	46	42,00
B-47868	46	7,55
B-47874	46	8,80
B-47880	46	9,60
B-47896	46	15,10
B-47905	46	7,30
B-47911	46	8,85
B-47933	46	11,45
B-47949	46	17,15
B-47955	46	21,00
B-47961	46	31,00
B-47977	46	48,00
B-47983	46	13,50
B-48751	117	4,80
B-48767	117	5,95
B-48773	117	16,35
B-48789	117	16,35
B-48832	217	166,00
B-48860	217	183,00
B-49046	49	29,00
B-49052	48	14,55
B-49638	97	110,00
B-49703	236	21,00
B-49719	236	27,00
B-49725	97	139,00
B-49884	97	149,00
B-50295	92	38,00
B-51867	115	34,00
B-51926	157	13,80
B-51932	157	15,40
B-51960	157	22,00
B-51976	157	28,00
B-52043	233	22,00
B-52532	116	25,00
B-52548	116	27,00
B-52554	116	46,00
B-52582	116	25,00
B-52598	116	27,00
B-52607	116	46,00
B-52635	116	27,00
B-52641	116	30,00
B-52657	116	48,00
B-52934	117	5,40
B-53986	144	23,00
B-53992	144	25,00
B-54025	144	33,00
B-54031	144	58,00
B-54053	144	74,00
B-54069	144	95,00
B-54081	119	34,00
B-54265	231	385,00
B-54346	319	185,00
B-54352	319	190,00
B-54368	319	214,00
B-54374	319	253,00
B-54380	319	47,00
B-54520	94	53,00
B-54667	117	2,70
B-54673	117	3,55

Código	Pág.	P.V.P. (€)
B-55310	148	52,00
B-55326	148	97,00
B-55332	148	175,00
B-55572	227	17,50
B-55588	227	21,00
B-55594	227	27,00
B-56378	155	3,60
B-56390	155	4,10
B-56437	85	12,00
B-56699	212	44,00
B-56708	212	69,00
B-56714	212	68,00
B-56720	212	57,00
B-56742	212	66,00
B-57336	211	47,00
B-57401	86	3,25
B-57417	86	3,25
B-57423	86	3,80
B-57439	86	3,85
B-57445	86	4,65
B-57451	86	4,65
B-57467	86	4,65
B-57473	86	5,20
B-57489	86	3,50
B-57495	86	3,55
B-57504	86	3,50
B-57510	86	4,10
B-57526	86	4,40
B-57532	86	13,80
B-57548	115	6,20
B-57554	117	6,25
B-57635	55	185,00
B-57641	55	218,00
B-57657	55	219,00
B-57663	55	246,00
B-57679	55	230,00
B-57685	55	273,00
B-57691	55	254,00
B-57700	55	337,00
B-57738	117	8,70
B-57744	117	10,65
B-57897	44	4,95
B-57906	44	5,20
B-57912	44	8,05
B-57928	44	8,30
B-57940	44	4,95
B-57956	44	5,20
B-57962	44	4,95
B-57978	44	5,20
B-57984	44	6,75
B-57990	44	8,05
B-58001	44	11,15
B-58023	44	7,00
B-58039	44	9,10
B-58045	44	11,40
B-58051	44	13,80
B-58067	44	6,25
B-58073	44	7,00
B-58089	44	10,15
B-58095	44	5,70
B-58104	44	5,95
B-58110	44	7,00
B-58126	44	8,30
B-58132	44	11,40
B-58154	44	18,20
B-58176	44	6,50
B-58198	44	5,95
B-58207	44	6,75
B-58213	44	7,55
B-58229	44	8,85
B-58235	44	11,45
B-58257	44	19,20
B-58263	44	26,00
B-58279	44	63,00
B-58372	44	26,00
B-58388	44	63,00
B-58497	44	65,00
B-58590	44	36,00
B-58609	44	75,00
B-58615	44	27,00
B-58621	44	31,00
B-58637	44	30,00
B-58659	44	36,00
B-58665	44	34,00
B-58687	44	45,00
B-58693	44	43,00
B-58702	44	49,00
B-58718	44	43,00
B-58724	44	54,00
B-58746	44	49,00
B-58752	44	63,00
B-58768	44	55,00
B-58774	44	69,00

Código	Pág.	P.V.P. (€)
B-58780	44	89,00
B-59075	48	19,20
B-62016	230	15,45
B-62496	45	3,15
B-62505	45	3,15
B-62511	45	3,75
B-62527	45	4,05
B-62608	45	3,85
B-62614	45	3,85
B-62620	45	4,40
B-62636	45	4,90
B-62642	45	5,20
B-62664	45	5,15
B-62670	45	5,15
B-62686	45	5,65
B-62692	45	6,20
B-62701	45	6,45
B-62739	45	6,95
B-62745	45	7,45
B-62751	45	8,00
B-62767	45	8,25
B-62773	45	9,25
B-62795	45	10,30
B-62804	45	10,80
B-62810	45	11,35
B-62826	45	11,60
B-62832	45	11,85
B-62854	45	12,35
B-62860	45	12,90
B-62876	45	13,50
B-62882	45	14,65
B-62898	45	15,20
B-62979	211	29,00
B-63149	211	59,00
B-63585	233	40,00
B-63591	233	48,00
B-63600	113	1,65
B-63616	113	1,65
B-63622	113	1,65
B-63638	113	1,65
B-63644	113	1,65
B-63650	113	1,65
B-63666	113	1,65
B-63672	113	1,65
B-63688	113	1,65
B-63694	113	1,65
B-63703	113	1,65
B-63719	113	2,45
B-63725	113	2,45
B-63731	113	2,45
B-63747	113	2,45
B-63753	113	2,45
B-63769	113	2,45
B-63775	113	2,45
B-63781	113	2,45
B-63797	113	2,45
B-63806	113	2,45
B-63812	113	2,45
B-64238	58	11,40
B-64244	58	11,40
B-64250	58	16,60
B-64294	58	7,80
B-64303	58	7,80
B-64319	58	11,45
B-64674	48	88,00
B-64799	192	17,00
B-64808	192	24,00
B-64814	192	12,90
B-64820	192	18,00
B-64836	192	14,40
B-64842	193	8,00
B-64842-5	193	41,00
B-64870-5	193	58,00
B-64858	192	11,35
B-64864	192	13,40
B-64870	193	11,60
B-64886	194	11,35
B-64892	193	17,50
B-64901	193	14,40
B-64917	193	7,70
B-64923	193	8,75
B-64939	193	11,35
B-64945	194	19,55
B-64951	193	23,00
B-64967	194	23,00
B-64973	192	23,00
B-64989	194	9,00
B-64995	194	9,25
B-64814-20	192	211,00
B-64858-20	192	130,00
B-64870-20	193	211,00
B-65006	194	15,95
B-65012	194	17,00

Código	Pág.	P.V.P. (€)
B-65028	195	26,00
B-65034	195	42,00
B-65040	195	23,00
B-65056	195	22,00
B-65062	196	22,00
B-65078	195	36,00
B-65084	195	23,00
B-65090	195	21,00
B-65109	195	21,00
B-65115	196	11,35
B-66400	198	12,90
B-66416	198	13,90
B-66422	198	23,00
B-66438	198	10,05
B-66444	198	23,00
B-66450	198	24,00
B-66466	199	13,40
B-66472	199	6,70
B-66494	200	28,00
B-66503	200	28,00
B-66519	199	38,00
B-66547	200	27,00
B-66553	200	21,00
B-66575	200	21,00
B-66793	112	4,55
B-66818	112	5,65
B-66824	112	3,10
B-66830	112	3,15
B-66846	112	3,10
B-66852	112	3,15
B-66880	112	40,00
B-67206	232	271,00
B-67240	214	65,00
B-67256	214	65,00
B-67480	196	45,00
B-67496	196	54,00
B-68127	45	2,60
B-68133	45	2,60
B-68177	45	19,60
B-68183	45	25,00
B-68199	45	31,00
B-68208	45	39,00
B-68236	45	24,00
B-68242	45	29,00
B-68258	45	38,00
B-68264	45	42,00
B-68389	178	32,00
B-68395	178	31,00
B-68404	178	27,00
B-68410	178	27,00
B-68426	178	27,00
B-68432	93	44,00
B-68448	125	16,20
B-69478	97	110,00
B-80014	274	201,00
B-80020	274	295,00
B-80036	274	164,00
D		
DML810	38	489,00
DML811	39	294,00
DML812	40	149,00
DML814	38	422,00
D-00016	47	1,20
D-00022	47	1,20
D-00038	47	1,20
D-00044	47	1,20
D-00050	47	1,20
D-00066	47	1,20
D-00072	47	1,50
D-00088	47	1,20
D-00094	47	1,20
D-00103	47	1,20
D-00119	47	1,20
D-00125	47	1,20
D-00131	47	1,20
D-00147	47	1,50
D-00153	47	1,85
D-00169	47	1,50
D-00175	47	1,50
D-00181	47	1,80
D-00197	47	1,80
D-00206	47	2,40
D-00228	47	1,50
D-00234	47	

Código	Pág.	P.V.P. (€)
D-07945	136	11,10
D-07951	136	12,45
D-07967	136	14,70
D-08056	47	1,50
D-08062	47	6,65
D-08517	47	8,55
D-08682	62	3,35
D-08707	62	5,55
D-08713	58	3,80
D-08729	58	3,65
D-08735	58	4,90
D-09167	253	9,55
D-09210	254	17,40
D-09226	254	18,30
D-09232	254	8,75
D-09248	254	8,75
D-09254	254	8,75
D-09260	254	8,75
D-09276	254	9,00
D-09282	254	9,00
D-09298	254	9,55
D-09307	254	10,80
D-09313	254	12,60
D-09329	255	12,90
D-09335	254	12,90
D-09341	254	24,00
D-09357	255	19,55
D-09363	255	24,00
D-09379	256	23,00
D-09385	256	22,00
D-09391	256	23,00
D-09400	256	25,00
D-09416	256	24,00
D-09422	255	17,50
D-09444	255	22,00
D-09472	255	15,20
D-09488	256	21,00
D-09494	256	21,00
D-09525	255	18,55
D-09547	255	22,00
D-09553	255	26,00
D-09575	255	25,00
D-09581	255	24,00
D-09628	208	12,60
D-09634	208	13,70
D-09640	208	29,00
D-09656	84	0,85
D-09662	84	0,80
D-09678	84	0,85
D-09684	84	0,85
D-09690	84	1,10
D-09709	84	1,10
D-09715	84	1,20
D-09721	84	1,45
D-09737	84	1,65
D-09743	84	1,75
D-09759	84	1,90
D-09765	84	2,25
D-09771	84	2,50
D-09787	84	3,25
D-09793	84	3,00
D-09802	84	3,55
D-09818	84	3,80
D-09824	84	4,35
D-09830	84	5,70
D-09846	84	6,00
D-09852	84	6,55
D-09868	84	7,10
D-09874	84	7,60
D-09880	84	8,20
D-10001	253	7,70
D-10017	253	8,50
D-10023	253	8,50
D-10039	253	8,75
D-10051	254	10,30
D-10067	254	11,35
D-10176	254	11,85
D-10182	254	12,90
D-10198	254	12,90
D-10285	254	16,50
D-10291	254	18,55
D-10300	254	21,00
D-10316	254	21,00
D-10322	254	22,00
D-10338	254	25,00
D-10344	254	24,00
D-10350	254	26,00
D-10366	254	28,00
D-10372	254	28,00
D-10388	254	21,00
D-10419	254	25,00
D-10425	254	30,00
D-10431	254	28,00

Código	Pág.	P.V.P. (€)
D-10447	254	31,00
D-10453	254	32,00
D-10469	254	32,00
D-10475	254	32,00
D-10497	255	21,00
D-10584	254	14,95
D-10687	256	15,95
D-10693	256	18,55
D-10702	256	15,95
D-10718	256	19,05
D-10746	256	31,00
D-11829	255	65,00
D-01155-25	47	21,65
D-01161-25	47	23,00
D-01177-25	47	28,00
D-01183-25	47	28,00
D-01199-25	47	35,00
D-03707-25	47	38,00
D-03713-25	47	34,00
D-03729-25	47	38,00
D-12027	256	41,00
D-14093	69	2,60
D-14928	85	1,65
D-14934	85	1,90
D-14940	85	1,90
D-14962	85	2,20
D-14978	85	3,00
D-15235	47	7,20
D-15241	47	7,95
D-15257	47	10,40
D-15263	47	11,55
D-15285	65	16,55
D-15300	65	17,15
D-15584	152	14,85
D-15609	152	14,85
D-15621	152	14,85
D-15643	152	14,85
D-15659	152	24,00
D-15665	47	1,15
D-15827	85	5,70
D-15833	85	8,70
D-15849	85	11,45
D-15855	85	14,70
D-15861	79	1,15
D-15877	79	1,15
D-15883	79	1,45
D-15899	79	1,45
D-15908	79	2,05
D-15914	79	2,35
D-15920	79	3,20
D-15936	79	5,00
D-15942	77	2,60
D-15958	77	2,60
D-15964	77	2,85
D-15970	77	2,85
D-15986	77	3,50
D-15992	79	4,05
D-16003	79	4,60
D-16019	79	5,45
D-16025	79	5,75
D-16031	79	5,70
D-16047	79	5,85
D-16053	79	6,55
D-16069	79	7,60
D-16075	79	9,50
D-16106	47	1,20
D-16128	47	2,75
D-16271	47	4,55
D-16287	47	5,75
D-16302	47	9,10
D-16318	47	16,45
D-16346	136	6,80
D-16368	59	35,00
D-16863	62	9,30
D-16879	62	6,10
D-16988	257	10,80
D-16994	98	3,50
D-17005	98	3,95
D-17011	98	4,50
D-17027	98	5,10
D-17033	98	5,10
D-17049	98	5,40
D-17055	98	5,95
D-17061	98	5,95
D-17077	98	6,80
D-17083	98	7,95
D-17099	98	8,30
D-17108	98	9,55
D-17114	98	10,75
D-17120	98	11,05
D-17136	98	11,90
D-17142	98	13,60
D-17158	98	17,25

Código	Pág.	P.V.P. (€)
D-17164	98	20,40
D-17170	99	4,05
D-17186	99	7,35
D-17192	99	2,95
D-17251	98	4,25
D-17267	98	5,10
D-17273	98	6,25
D-17289	86	1,35
D-17295	86	1,35
D-17304	86	1,40
D-17310	86	1,45
D-17332	86	1,45
D-17348	86	1,65
D-17354	86	1,90
D-17360	86	1,95
D-17376	86	2,45
D-17382	86	2,55
D-17398	86	3,00
D-17407	86	3,45
D-17413	86	4,65
D-17429	86	5,70
D-17435	86	6,00
D-17441	86	6,00
D-17457	86	8,05
D-17463	86	9,05
D-17479	86	10,10
D-17485	86	10,35
D-17491	86	12,95
D-17500	86	13,10
D-17516	86	15,55
D-17522	86	16,65
D-17538	47	4,25
D-17544	47	4,90
D-17566	47	6,70
D-17572	47	19,90
D-17603	99	5,95
D-17619	99	9,70
D-17631	66	18,90
D-17647	66	18,90
D-17778	85	4,10
D-19180	50	56,00
D-19196	63	9,50
D-20074	63	8,40
D-20694	62	5,20
D-20769	91	12,05
D-23759	91	9,50
D-23793	77	1,95
D-23802	77	2,00
D-23818	77	2,70
D-23824	64	9,00
D-23868	65	21,75
D-24072	133	3,80
D-24094	133	4,35
D-24119	133	5,20
D-24131	133	5,75
D-24153	133	6,55
D-24876	98	7,65
D-24882	98	8,85
D-25616	58	5,20
D-25688	98	8,35
D-25694	98	10,20
D-27034	158	3,15
D-27040	158	3,15
D-27056	158	3,15
D-27062	158	3,15
D-27084	158	3,60
D-27090	158	3,60
D-27109	158	3,60
D-27115	158	3,60
D-27137	158	7,20
D-27143	158	7,20
D-27159	158	7,20
D-27165	158	7,20
D-27838	159	5,15
D-27844	159	5,15
D-27850	159	5,15
D-27866	159	5,15
D-27888	159	6,20
D-27894	159	6,20
D-27903	159	6,20
D-27919	159	6,20
D-27931	159	10,30
D-27947	159	10,30
D-27953	159	10,30
D-27969	159	10,30
D-28036	160	3,70
D-28042	160	3,70
D-28058	160	3,70
D-28064	160	3,70
D-28086	160	4,20
D-28092	160	4,20
D-28101	160	4,20
D-28117	160	4,20

Código	Pág.	P.V.P. (€)
D-28139	160	7,20
D-28145	160	7,20
D-28151	160	7,20
D-28167	160	7,20
D-28173	160	5,15
D-28189	160	5,15
D-28195	160	5,15
D-28204	160	5,15
D-28210	160	10,30
D-28226	160	10,30
D-28232	160	10,30
D-28248	160	10,30
D-28298	158	6,45
D-28307	158	6,45
D-28313	158	6,45
D-28329	158	6,45
D-28335	158	7,45
D-28341	158	7,45
D-28357	158	7,45
D-28363	158	7,45
D-28379	158	13,40
D-28385	158	13,40
D-28391	158	13,40
D-28400	158	13,40
D-29050	208	23,00
D-29228	66	20,05
D-29284	133	6,25
D-29290	133	9,55
D-29561	133	6,00
D-29577	133	7,90
D-30140	98	8,90
D-30209	253	21,35
D-30287	78	0,85
D-30293	78	0,85
D-30302	78	0,85
D-30324	78	0,90
D-30346	78	1,15
D-30368	78	1,15
D-30374	78	1,40
D-30380	78	1,45
D-30411	78	2,00
D-30427	78	4,30
D-30449	78	2,30
D-30455	78	2,60
D-30461	78	5,75
D-30477	91	6,60
D-30667	118	11,35
D-31033	78	0,85
D-31061	78	0,90
D-31669	118	50,00
D-31778	95	89,00
D-33691	94	68,00
D-34176	60	5,80
D-34182	60	7,25
D-34198	60	9,30
D-34207	60	5,80
D-34213	60	7,55
D-34229	60	9,00
D-34235	60	8,25
D-34241	60	13,35
D-34366	118	9,20
D-34805	65	21,75
D-34914	118	50,00
D-35003	151	26,00
D-35019	151	25,00
D-35025	151	21,25
D-35302	136	41,00
D-35368	98	3,40
D-35374	98	4,00
D-35380	98	4,50
D-35396	98	5,10
D-35405	98	5,35
D-35411	98	5,65
D-35427	98	5,95
D-35433	98	6,50
D-35449	98	6,80
D-35455	98	7,35
D-35461	98	7,65
D-35477	98	7,65
D-35483	98	8,30
D-35499	98	8,30
D-35508	98	9,50
D-35514	98	10,50
D-35520	98	10,75
D-35536	98	11,05
D-35542	98	11,90
D-35558		

Código	Pág.	P.V.P. (€)
D-42298	80	12,85
D-42307	80	17,55
D-42357	59	30,00
D-42450	61	46,00
D-42961	85	3,10
D-42977	85	3,10
D-42983	85	3,10
D-43000	85	3,10
D-43038	85	3,10
D-43044	85	3,10
D-43072	85	2,05
D-43094	85	2,30
D-43119	85	2,60
D-43125	85	2,85
D-43131	85	3,10
D-43147	85	3,10
D-43153	85	3,60
D-43169	85	5,40
D-43175	85	5,40
D-43181	85	6,70
D-43197	85	6,95
D-43206	85	7,20
D-43212	85	10,30
D-43228	85	13,40
D-43234	85	15,95
D-44432	151	36,00
D-44454	151	28,00
D-44476	151	35,00
D-44507	151	44,00
D-44529	151	55,00
D-45375	85	10,30
D-45381	85	10,30
D-45397	85	15,20
D-45509	130	4,90
D-45515	130	6,55
D-45521	130	7,60
D-45537	130	4,90
D-45543	130	6,55
D-45559	130	7,60
D-45565	131	3,85
D-45571	131	4,65
D-45587	131	4,90
D-45593	131	6,55
D-45602	131	7,60
D-45618	131	3,85
D-45624	131	4,65
D-45630	131	4,90
D-45646	131	6,55
D-45652	131	7,60
D-45668	129	3,00
D-45674	129	3,80
D-45680	129	4,35
D-45696	129	6,00
D-45705	129	3,00
D-45711	129	3,80
D-45727	129	4,35
D-45733	129	6,00
D-45749	130	8,20
D-45755	130	8,20
D-45761	133	10,35
D-45777	133	13,10
D-46202	91	21,55
D-47117	99	45,00
D-47123	99	38,00
D-47139	99	45,00
D-47298	99	102,00
D-52554	209	7,20
D-52560	209	8,45
D-52576	209	10,25
D-52582	209	9,05
D-52598	209	10,25
D-52607	209	11,45
D-52613	209	15,65
D-52629	209	18,10
D-52635	209	20,50
D-52766	145	8,15
D-53453	79	2,65
D-53469	79	3,25
D-53475	79	6,00
D-53481	79	6,55
D-53497	79	9,55
D-53506	79	10,65
D-53534	253	63,00
D-53540	253	65,00
D-53724	159	2,90
D-53730	159	2,90
D-53746	159	2,90
D-53752	159	2,90
D-53774	159	3,35
D-53780	159	3,35
D-53796	159	3,35
D-53805	159	3,35
D-53827	159	7,45

Código	Pág.	P.V.P. (€)
D-53833	159	7,45
D-53849	159	7,45
D-53855	159	7,45
D-54081	90	18,10
D-54972	69	138,00
D-56960	182	2,15
D-56982	145	63,00
D-56998	145	78,00
D-57009	145	91,00
D-65953-10	156	6,90
D-65969-10	156	7,95
D-61070	151	17,40
D-61086	151	17,95
D-61092	151	18,50
D-61101	151	26,00
D-61123	145	8,15
D-61145	145	17,50
D-61151	145	8,15
D-61167	145	9,35
D-61173	145	20,95
D-61189	145	7,00
D-61690	114	1,95
D-62505	183	4,60
D-62511	183	6,50
D-62527	183	7,65
D-62533	183	4,60
D-62549	183	6,50
D-62555	183	7,65
D-62561	183	4,60
D-62577	183	6,50
D-62583	183	7,65
D-62599	183	4,60
D-62608	183	6,50
D-62614	183	7,65
D-62620	183	4,60
D-62636	183	6,50
D-62642	183	7,65
D-62658	183	4,60
D-62664	183	6,50
D-62670	183	7,65
D-63666	136	25,00
D-63747	159	1,85
D-63753	159	1,85
D-63769	159	1,85
D-63775	159	1,85
D-63781	159	2,15
D-63797	159	2,15
D-63806	159	2,10
D-63812	159	2,10
D-63828	159	4,25
D-63834	159	4,25
D-63840	159	4,25
D-63856	159	4,25
D-64951	209	10,55
D-64967	209	12,05
D-64973	209	14,35
D-64995	118	9,75
D-67527	90	23,00
D-67549	90	46,00
D-67561	90	58,00
D-67583	90	62,00
D-67614	80	1,75
D-70742	131	10,35
D-70758	131	10,35
D-70786	183	17,45
D-70792	183	17,45
D-70873	182	17,45
D-71211	136	14,30
D-71962	91	7,95
D-72154	306	23,00
D-72160	306	23,00
D-72291	209	13,05
D-72300	209	14,25
D-72316	215	33,00
D-72322	215	37,00
D-72338	215	42,00
D-72780	78	1,70
D-72833	90	6,00
D-72861	91	4,95
D-72877	90	5,45
D-73271	118	4,15
D-73455	92	8,75
D-73461	92	30,00
D-73477	92	28,00
D-73508	101	16,20
D-73514	101	17,35
D-73520	101	17,35
D-73542	101	10,40
D-73601	130	1,45
D-73617	130	1,70
D-73623	130	1,85
D-73639	130	2,10
D-73645	130	2,60

Código	Pág.	P.V.P. (€)
D-73651	131	1,45
D-73667	131	1,55
D-73673	131	1,75
D-73689	131	1,85
D-73695	131	2,10
D-73704	129	1,35
D-73710	129	1,55
D-73726	129	1,85
D-73732	129	2,10
D-73798	130	4,65
D-73807	130	5,15
D-73813	131	4,45
D-73829	131	4,65
D-73835	129	2,25
D-73841	129	2,90
D-73857	129	3,40
D-73863	129	4,45
D-73891	51	7,20
D-73900	51	7,70
D-73916	51	8,00
D-73922	51	9,30
D-73938	51	12,10
D-73944	51	16,50
D-73950	51	19,55
D-73966	51	22,00
D-73972	51	1,65
D-73988	51	3,90
D-73994	51	5,90
D-74005	51	8,25
D-74011	51	17,50
D-74027	51	22,00
D-74136	49	8,25
D-74304	81	11,85
D-74310	81	13,90
D-74326	81	15,45
D-74332	81	16,50
D-74348	81	18,55
D-74354	81	22,00
D-74360	81	24,00
D-74376	81	27,00
D-74382	81	32,00
D-74398	81	36,00
D-74407	81	54,00
D-74413	81	63,00
D-74429	81	80,00
D-74435	81	1,30
D-74441	81	1,30
D-74457	81	10,30
D-74463	81	12,35
D-74479	81	14,95
D-74728	49	8,25
DML816X	42	77,00
DEADML805	39	174,00
DEADML809	39	443,00
DEAADP06	31	29,00
DEAADP08	31	29,00
DEAML103	40	29,00
DEAML104	42	102,00
DEAML106	41	62,00
DEAWST05	221	326,00
DEAWST07	221	407,00
DEBML105	41	58,00
DEBWS06	221	297,00
DEBDML186	40	24,00
DEBDML800	40	46,00
DEBDML801	42	48,00
DEBDML802	41	55,00
DEBDML806	42	77,00
DEBDML808	41	62,00
DEBDML815	41	39,00
DECADP05	31	30,00
D-01208-25	47	28,00
DA00000002	313	8,00
DA00000169	310	15,45
E		
E-00022	118	220,00
E-00365	155	1,75
E-00371	155	2,25
E-00387	155	1,85
E-00393	155	2,05
E-00402	155	2,80
E-00418	155	2,05
E-01769	315	3,10
E-01775	315	5,80
E-01781	315	42,00
E-01797	315	3,90
E-01806	315	7,35
E-01812	315	44,00
E-01828	315	4,45
E-01834	315	8,15
E-01840	315	42,00
E-01909	211	41,00
E-02060	146	37,00

Código	Pág.	P.V.P. (€)
E-02076	146	40,00
E-02967	146	139,00
E-03121	110	3,10
E-03137	110	3,10
E-03159	110	3,10
E-03165	110	3,10
E-03171	110	3,10
E-03187	110	3,10
E-03193	110	3,10
E-03202	110	3,10
E-03218	110	3,10
E-03224	110	3,10
E-03230	110	3,10
E-03268	110	6,20
E-03274	110	6,20
E-03280	110	6,20
E-03296	110	6,20
E-03305	110	6,20
E-03311	110	6,20
E-03327	110	6,20
E-03333	110	6,20
E-03349	110	6,20
E-03355	110	6,20
E-03361	110	6,20
E-03399	111	8,00
E-03408	111	8,75
E-03414	111	9,25
E-03420	111	6,20
E-03436	111	6,20
E-03442	110	4,10
E-03458	111	6,20
E-03464	111	6,20
E-03470	111	6,20
E-03486	111	6,45
E-03492	111	8,75
E-03517	111	9,25
E-03523	111	9,55
E-03573	111	23,00
E-03654	100	8,00
E-03660	100	8,00
E-03676	100	8,50
E-03698	100	10,30
E-03707	100	9,80
E-03713	100	9,80
E-03735	100	10,20
E-03757	100	10,80
E-03763	100	10,30
E-03779	100	11,35
E-03785	100	11,35
E-03791	100	11,85
E-03800	100	11,85
E-03822	100	12,35
E-03838	100	13,15
E-03850	100	14,15
E-03872	100	14,15
E-03894	100	15,00
E-03925	100	16,20
E-03931	100	16,20
E-03947	100	18,55
E-03953	100	19,05
E-03969	100	19,55
E-03981	100	25,00
E-04977-5	157	39,00
E-04008	100	25,00
E-04014	100	32,00
E-04020	100	32,00
E-04036	100	36,00
E-04042	100	32,00
E-04064	100	42,00
E-04070	100	24,00
E-04086	100	6,45
E-05094	333	28,00
E-05119	334	20,10
E-05125	335	55,00
E-05131	336	38,00
E-05147	338	49,00
E-05153	339	55,00
E-05169	340	113,00
E-05175	342	139,00
E-05181	337	40,00
E-05197	344	25,00
E-05206	345	25,00
E-05212	346	

Código	Pág.	P.V.P. (€)
E-11330	52	16,10
E-11346	52	14,45
E-11352	52	18,35
E-11368	52	17,20
E-11374	52	21,10
E-11380	52	23,00
E-11396	52	27,00
E-11405	52	27,00
E-11411	52	33,00
E-11427	52	32,00
E-11433	52	37,00
E-11449	52	36,00
E-11455	52	42,00
E-11461	52	37,00
E-11477	52	43,00
E-11483	52	47,00
E-11499	52	57,00
E-11508	52	57,00
E-11514	52	70,00
E-11536	90	7,70
E-11542	121	162,00
E-11689	93	113,00
E-11782	364	108,00
E-12027	110	4,90
E-12354	124	31,00
E-12360	113	13,65
E-12376	113	13,65
E-12382	113	13,65
E-12398	113	13,65
E-12407	113	9,80
E-12413	113	9,80
E-12429	113	9,80
E-12435	113	9,80
E-12653	113	13,65
E-12669	113	13,65
E-12675	113	9,80
E-12681	113	9,80
E-12712	365	149,00
E-12980	370	21,00
E-13041	61	57,00
E-14495	44	7,70
E-14504	44	9,25
E-14510	44	10,80
E-14526	44	14,95
E-14532	44	7,20
E-14548	44	8,75
E-14554	44	9,80
E-14560	44	13,90
E-14576	44	21,00
E-14635	44	10,30
E-14641	44	13,90
E-14657	44	15,95
E-14663	44	17,00
E-14679	44	22,00
E-14685	44	29,00
E-14691	44	15,95
E-14700	44	18,00
E-14716	44	19,55
E-14722	44	26,00
E-14738	44	16,50
E-14744	44	18,55
E-14750	44	21,00
E-14766	44	23,00
E-14772	44	29,00
E-14928	48	48,00
E-03006-25	156	57,00
E-10861-12	156	19,55
E-10877-12	156	22,00
E-12441-10	113	227,00
EE80700013	385	6,50
EE80700019	385	6,50
F		
F-30913	271	15,70
F-31140	271	21,00
F-31166	271	20,10
F-31182	271	26,00
F-31227	271	15,20
F-31230	271	16,75
F-31825	272	13,40
F-31838	272	14,40
F-31841	272	16,20
F-31854	272	18,00
F-32142	272	25,00
F-32155	272	29,00
F-32168	272	33,00
F-32171	272	37,00
F-32647	273	13,90
F-32650	273	12,35
F-32663	273	16,50
F-32676	273	18,55
F-32689	273	19,55
F-32843	271	35,00
F-32856	271	39,00

Código	Pág.	P.V.P. (€)
F-32869	271	32,00
F-32872	271	33,00
F-32885	271	35,00
F-32898	271	41,00
F-33562	272	44,00
F-33575	272	53,00
F-33588	272	55,00
F-33591	272	84,00
F-81518	273	23,50
F-81521	273	18,00
G		
GM00001396	39	20,10
GM00001499	32	23,00
GM00001605	31	45,00
GM00002073	39	213,00
GM00002283	39	67,00
GM00002286	39	19,55
GM00002287	39	13,40
H		
HG130442	382	22,00
HW3086	322	16,20
H311225	138	65,00
HW40167	322	50,00
HW40551	322	29,00
HW40925	322	48,00
HW41154	322	24,00
HW41163	323	56,00
HW41165	323	62,00
HW41167	323	98,00
HW41175	323	55,00
HW41179	323	26,00
HW41181	323	70,00
HW41185	323	18,00
HW41187	323	31,00
HW41847	322	51,00
HW41849	323	72,00
HW46221	322	26,00
HW2500390	322	170,00
HW3082750	324	12,60
HW3083550	322	75,00
HW3163270	322	160,00
HW3320120	322	4,30
HW3320130	322	4,30
HW3320152	322	8,65
HW3640090	324	3,25
HW3640630	322	10,80
HW3640640	322	3,50
HW3640660	322	44,00
HW3640670	322	2,30
HW3640920	322	27,00
HW3640940	322	10,55
HW3640950	323	5,95
HW3641150	322	10,25
HW3641570	322	59,00
HY00000090	382	19,55
HY00000212	274	193,00
J		
JM21000300	237	83,00
JM21000320	237	23,00
JM21000330	237	14,95
JM21080230	237	19,55
JM21080260	237	10,80
JM23000123	385	3,20
JM23000127	222	9,25
JM23000128	222	0,75
JM23000131	223	7,70
JM23100500	222	10,70
JM23100501	224	3,45
JM23100502	223	6,10
JM23300008	223	52,00
JM23510009	223	10,30
JM23510010	224	6,70
JM27000090	237	0,75
JM27000300	222	257,00
JM27100005	223	37,00
JM27170001	216	31,00
L		
LE00772796	296	24,00
LE00784968	294	66,00
LE00785633	295	14,40
LE00785638	296	16,75
LE00789389	295	42,00
LE00791661	295	97,00
LE00796587	294	330,00
LE00796588	294	61,00
LE00822220	296	29,00
LE00823195	296	23,00
LE00834534	296	18,55
LE00837085	294	167,00
LE00837096	294	50,00
LE00855702	294	221,00
LE00864505	296	36,00
LE00870131	295	31,00

Código	Pág.	P.V.P. (€)
LE00870134	295	43,00
LE00870137	295	72,00
LE00874658	294	103,00
LE00929103	296	43,00
LE00929104	295	78,00
M		
ML001G	41	50,00
ML002G	42	118,00
ML003GZ	39	216,00
ML006GX	42	84,00
P		
PILOTL	87	9,00
PILOTS	87	7,20
P-00860	178	4,20
P-00882	178	5,50
P-00907	178	5,50
P-00913	178	5,50
P-00935	178	5,80
P-00957	178	5,00
P-00979	178	6,30
P-00985	178	6,30
P-00991	178	6,55
P-01002	178	6,85
P-01018	178	6,85
P-01030	178	7,90
P-01052	178	8,15
P-01074	178	8,15
P-01080	178	8,15
P-01096	178	7,60
P-01105	178	7,60
P-01127	135	61,00
P-01155	135	61,00
P-01199	181	10,30
P-01208	181	10,30
P-01214	181	10,30
P-01220	181	10,30
P-01236	181	10,30
P-01395	181	11,35
P-01404	181	11,35
P-02319	56	147,00
P-02325	101	10,30
P-02331	101	14,40
P-02347	101	13,90
P-02353	101	32,00
P-03763	54	8,80
P-03779	54	85,00
P-03785	54	89,00
P-03791	54	108,00
P-03800	54	122,00
P-03816	54	144,00
P-03822	54	166,00
P-03838	54	9,35
P-03844	55	136,00
P-03850	55	166,00
P-03866	55	206,00
P-03872	55	262,00
P-03888	55	56,00
P-03894	55	47,00
P-03925	55	91,00
P-03931	55	21,00
P-03947	61	77,00
P-04008	55	129,00
P-04014	55	183,00
P-04020	55	187,00
P-04036	55	370,00
P-04400	134	108,00
P-04416	134	87,00
P-04422	134	103,00
P-04438	134	104,00
P-04444	134	104,00
P-04450	134	104,00
P-04466	134	103,00
P-04874	228	13,90
P-04896	228	13,90
P-04955	228	15,50
P-05038	233	20,85
P-05044	233	24,00
P-05050	233	51,00
P-05066	233	46,00
P-05088	229	20,35
P-05474	68	25,00
P-05480	68	28,00
P-05496	68	24,00
P-05533	58	14,95
P-05549	65	31,00
P-05555	65	76,00
P-05561	65	45,00
P-05583	65	44,00
P-05608	65	58,00
P-05614	63	20,10
P-05620	63	15,45
P-05636	63	14,60
P-05642	63	19,60

Código	Pág.	P.V.P. (€)
P-05658	63	23,00
P-05664	63	29,00
P-05670	63	63,00
P-05686	63	37,00
P-05692	66	28,00
P-05701	66	49,00
P-05717	66	70,00
P-05723	66	27,00
P-05929	246	13,40
P-05941	125	43,00
P-05963	125	37,00
P-06030	114	8,25
P-06046	114	24,00
P-06052	114	8,25
P-06068	114	23,00
P-06074	114	8,25
P-06080	114	23,00
P-06096	114	8,25
P-06105	114	23,00
P-06111	114	8,25
P-06127	114	23,00
P-06133	114	8,25
P-06149	114	23,00
P-06177	114	13,40
P-06199	114	13,40
P-06214	114	13,40
P-06242	114	14,40
P-06323	114	13,40
P-06339	114	13,40
P-06345	114	13,40
P-06351	114	13,40
P-06367	114	13,40
P-06373	114	13,40
P-06389	114	13,40
P-08361	69	3,10
P-08844	258	46,00
P-08850	258	46,00
P-10067	151	15,70
P-10073	151	16,50
P-11835*	105	12,35
P-13041	62	21,00
P-13057	62	14,95
P-13063	62	17,40
P-13079	62	20,15
P-13100	62	37,00
P-13122	63	15,30
P-13138	63	19,65
P-13144	63	15,65
P-13150	63	18,50
P-13166	63	27,00
P-13188	63	23,00
P-13219	63	54,00
P-13231	67	18,05
P-13253	67	23,00
P-13269	67	25,00
P-13275	67	18,05
P-13297	67	21,00
P-13306	67	27,00
P-13312	67	31,00
P-13334	67	54,00
P-13378	64	17,80
P-13384	64	23,00
P-13390	64	24,00
P-13409	64	18,60
P-13415	64	24,00
P-13437	64	39,00
P-13487	65	30,00
P-13493	65	61,00
P-13502	65	31,00
P-13518	65	73,00
P-13552	114	3,70
P-13568	114	5,90
P-13574	114	3,60
P-13580	114	5,65
P-15718	104	36,00
P-16237	60	8,00
P-16		

Código	Pág.	P.V.P. (€)
P-33152	173	4,10
P-33168	173	4,10
P-33174	175	6,45
P-33180	175	6,20
P-33196	175	6,20
P-33205	175	6,20
P-33211	175	6,20
P-33233	175	5,90
P-33249	175	5,90
P-33255	173	3,85
P-33255	197	3,85
P-33261	173	3,85
P-33261	197	3,85
P-33277	173	3,85
P-33277	197	3,85
P-33283	173	3,60
P-33283	197	3,60
P-33299	173	3,60
P-33299	197	3,60
P-33308	173	3,60
P-33314	173	3,60
P-33314	197	3,60
P-33320	173	3,60
P-33320	197	3,60
P-33336	173	3,60
P-33342	177	4,65
P-33358	177	4,40
P-33364	177	4,10
P-33370	177	4,10
P-33386	177	4,10
P-33392	177	4,10
P-33401	177	4,10
P-33417	177	4,10
P-33423	177	4,10
P-33439	178	10,30
P-33445	178	8,00
P-33451	178	7,70
P-34718	150	24,00
P-34724	151	17,50
P-35807	173	5,40
P-35813	173	5,15
P-35829	173	4,90
P-35835	173	4,90
P-35841	173	4,90
P-35857	173	4,90
P-35863	173	4,90
P-35879	173	4,90
P-35885	173	4,90
P-35891	174	4,65
P-35900	174	4,65
P-35916	174	4,65
P-35922	174	4,65
P-36011	174	3,35
P-36027	174	3,35
P-36033	174	3,35
P-36049	174	3,35
P-36136	174	3,10
P-36142	174	2,85
P-36158	174	2,85
P-36267	175	4,10
P-36273	175	3,85
P-36289	175	3,85
P-36398	172	3,85
P-36407	172	3,35
P-36413	172	3,10
P-36429	172	3,10
P-36516	172	4,65
P-36522	172	4,10
P-36538	172	4,10
P-36544	172	4,10
P-36550	172	4,10
P-36566	172	4,10
P-36572	172	4,10
P-36588	172	4,10
P-36675	181	4,90
P-36681	181	4,40
P-36697	181	4,40
P-36706	181	4,40
P-36712	181	4,40
P-36728	181	4,40
P-36734	181	4,40
P-36887	180	12,90
P-36893	180	11,85
P-36902	180	11,85
P-36918	180	11,85
P-36924	180	11,85
P-36930	180	11,85
P-36946	180	11,85
P-37091	180	9,25
P-37100	180	9,00
P-37116	180	9,00
P-37122	180	9,00
P-37138	180	9,00

Código	Pág.	P.V.P. (€)
P-37144	180	9,00
P-37150	180	9,00
P-37172	180	9,80
P-37188	180	9,25
P-37194	180	8,75
P-37203	180	8,50
P-37219	180	8,50
P-37225	180	8,50
P-37231	180	8,50
P-37312	180	10,80
P-37328	180	10,30
P-37334	180	9,80
P-37340	180	9,00
P-37356	180	9,00
P-37362	180	9,00
P-37378	180	9,00
P-37839	177	6,95
P-37845	177	6,45
P-37851	177	6,20
P-37867	177	5,90
P-37873	177	5,90
P-37889	177	5,90
P-37895	177	5,90
P-37904	177	5,90
P-37910	177	5,90
P-37926	177	5,90
P-37932	177	5,90
P-38037	178	8,50
P-38043	178	7,70
P-38059	178	7,70
P-38065	178	7,70
P-38102	176	8,00
P-38118	176	6,20
P-38124	176	5,40
P-38130	176	5,15
P-38146	176	5,15
P-38152	176	5,15
P-38168	176	5,15
P-38174	176	5,15
P-38180	176	4,10
P-38196	176	55,00
P-38205	176	45,00
P-38211	176	39,00
P-38227	176	36,00
P-38233	176	36,00
P-38249	176	36,00
P-38255	176	36,00
P-38261	176	36,00
P-38277	176	36,00
P-38283	271	29,00
P-38788	246	14,45
P-38794	246	14,45
P-39394	181	30,00
P-39419	181	30,00
P-39425	181	30,00
P-40082	152	721,00
P-40098	152	35,00
P-40107	152	1,80
P-40113	152	9,55
P-40129	152	4,40
P-40288	152	12,35
P-41551	150	24,00
P-41604	150	34,00
P-41610	150	39,00
P-41626	150	49,00
P-41632	150	63,00
P-41648	150	79,00
P-41676	151	49,00
P-41682	151	48,00
P-41698	151	39,00
P-41707	151	45,00
P-41735	152	12,35
P-41866	151	18,45
P-41872	151	134,00
P-41888	151	25,00
P-41903	151	74,00
P-41919	151	3,35
P-41931	151	4,90
P-41981	151	10,80
P-42151	151	33,00
P-42684	173	4,10
P-42690	173	3,85
P-42709	173	3,85
P-42715	173	3,85
P-42721	173	3,85
P-42737	173	3,85
P-42743	173	3,85
P-42759	173	3,85
P-42765	173	3,85
P-42868	172	6,20
P-42874	172	6,20
P-42880	172	5,90
P-42896	172	5,90

Código	Pág.	P.V.P. (€)
P-42905	172	5,90
P-42911	172	5,65
P-42927	172	5,65
P-42933	172	5,65
P-43022	175	7,20
P-43038	175	6,70
P-43044	175	6,45
P-43050	175	6,20
P-43066	175	6,20
P-43072	175	5,65
P-43088	175	6,20
P-43094	175	6,20
P-43181	181	5,40
P-43197	181	5,40
P-43206	181	5,15
P-43212	181	5,15
P-43228	181	5,15
P-43234	181	5,15
P-43240	181	5,15
P-43256	181	6,20
P-43262	181	6,20
P-43278	181	5,90
P-43284	181	5,90
P-43290	181	5,90
P-43309	181	5,90
P-43315	181	5,90
P-43321	181	8,00
P-43337	181	7,70
P-43343	181	7,45
P-43359	181	7,20
P-43365	181	7,20
P-43371	181	7,45
P-43387	181	7,45
P-43533	177	5,15
P-43549	177	4,90
P-43555	177	4,65
P-43561	177	4,65
P-43577	177	4,65
P-43583	177	4,65
P-43599	177	4,65
P-43608	177	4,40
P-43614	177	4,40
P-44074	117	11,85
P-45082	151	35,00
P-45135	382	47,00
P-45680	231	17,10
P-45696	231	20,85
P-45705	227	17,10
P-45711	227	20,85
P-45727	227	25,00
P-45749	245	8,05
P-45864	273	14,85
P-45870	273	15,95
P-45886	273	19,80
P-45892	273	23,00
P-45901	273	25,00
P-45917	273	28,00
P-45923	272	11,55
P-45939	272	13,20
P-45945	272	15,40
P-45951	272	16,50
P-45967	272	19,25
P-46997	227	15,00
P-47008	227	19,25
P-47014	232	14,40
P-47064	231	18,55
P-47086	229	12,85
P-47092	229	13,90
P-47101	230	19,25
P-47117	229	15,50
P-47123	230	16,60
P-47173	233	16,05
P-47189	232	15,00
P-47195	232	19,80
P-47204	245	9,90
P-47210	245	9,35
P-47226	245	7,75
P-47232	246	7,75
P-47357	317	8,50
P-47363	317	10,30
P-49622	245	10,45
P-49638	245	11,75
P-49644	246	13,40
P-52174	155	1,10
P-52180	155	1,30
P-52196	155	2,40
P-52205	155	1,30
P-52211	155	2,85
P-52227	155	3,10
P-52233	155	3,10
P-52249	155	1,30
P-52255	155	1,30
P-52819	155	4,40

Código	Pág.	P.V.P. (€)
P-52928	155	1,80
P-52934	155	1,80
P-52940	155	1,55
P-52962	155	2,05
P-52978	155	1,55
P-52984	155	1,80
P-52990	155	2,60
P-53001	155	1,30
P-53017	155	1,30
P-53023	155	1,35
P-53039	155	1,35
P-53045	155	1,30
P-53051	155	1,35
P-53067	155	3,10
P-53073	155	1,30
P-53089	155	1,80
P-53095	155	1,35
P-53126	155	1,30
P-53148	155	3,85
P-53154	155	5,15
P-53263	115	17,50
P-53914	56	191,00
P-53920	56	27,00
P-53936	56	34,00
P-53942	56	47,00
P-54075	115	18,00
P-54178	151	196,00
P-54184	151	28,00
P-54190	152	1.324,00
P-54221	151	97,00
P-57102	150	67,00
P-57118	150	69,00
P-57124	150	69,00
P-57146	150	69,00
P-57152	150	70,00
P-57174	150	72,00
P-63797	61	41,00
P-63806	150	97,00
P-63828	150	124,00
P-63921	150	165,00
P-64060	150	39,00
P-64076	150	41,00
P-64082	150	43,00
P-64098	150	43,00
P-64107	150	47,00
P-64113	150	48,00
P-64129	150	49,00
P-64272	66	47,00
P-64288	66	47,00
P-64319	76	28,00
P-64331	76	34,00
P-64347	50	6,25
P-64347	76	6,25
P-64462	76	29,00
P-64478	76	29,00
P-64484	76	33,00
P-64490	76	34,00
P-64509	76	35,00
P-64515	76	36,00
P-64521	76	38,00
P-64537	76	42,00
P-64543	76	42,00
P-64559	76	42,00
P-64565	76	43,00
P-64571	76	46,00
P-64587	76	52,00
P-64593	76	53,00
P-64602	76	54,00
P-64618	76	55,00
P-64630	76	57,00
P-64646	76	62,00
P-64652	76	64,00
P-64668	76	83,00
P-64858	323	21,00
P-64864	324	17,50
P-64870	324	9,80
P-64892	323	43,00
P-64901	322	38,00
P-64917	322	83,00
P-65648	134	105,00
P-65931	66	36,00
P-65		

Código	Pág.	P.V.P. (€)
P-78178	52	167,00
P-78184	52	228,00
P-78190	52	177,00
P-78215	52	201,00
P-78293	283	35,00
P-81088	294	84,00
P-81309	296	72,00
P-81315	294	251,00
P-81739	281	36,00
P-81745	281	21,00
P-81745	284	21,00
P-81789	281	26,00
P-83652	379	32,00
P-83668	379	10,80
P-83705	379	22,00
P-83886	379	120,00
P-84084	281	65,00
P-84137	379	89,00
P-84171	378	14,40
P-84268	379	16,65
P-84274	379	19,25
P-84311	378	182,00
P-84327	378	216,00
P-84333	378	208,00
PDC1200A01	29	1.854,00
PDC1200A02	29	1.741,00
PR00000028	267	7,65
PR00000029	267	7,65
PR00000030	267	9,85
PR00000031	267	8,20
PR00000032	267	16,30
PR00000033	267	17,90
PR00000034	267	7,65
PR00000035	267	10,35
PR00000039	267	9,00
PR00000041	267	20,75
S		
SC00000203	300	108,00
SC00000205	300	108,00
SC00000207	300	108,00
SC00000209	300	108,00
SC00000211	300	108,00
SC00000213	300	108,00
SC00000215	300	108,00
SC00000217	300	108,00
SC00000219	300	108,00
SC00000221	300	108,00
SC00000223	300	108,00
SC00000244	300	108,00
SC00000246	300	108,00
SC00000248	300	108,00
SC00000250	300	108,00
SC00000252	300	108,00
SC00000254	300	108,00
SC00000256	300	108,00
SC00000258	300	108,00
SC00000260	300	108,00
SC00000262	300	108,00
SC00000264	300	108,00
SC00000266	300	108,00
SC03300790	299	80,00
SC03801080	299	88,00
SC05332710	300	108,00
SC05340040	300	108,00
SC05340050	300	108,00
SC05340060	300	108,00
SC05340070	300	108,00
SC05340080	300	108,00
SC05340090	300	108,00
SC05340100	300	108,00
SC05340110	300	108,00
SC05340120	300	108,00
SC05340130	300	108,00
SC05340140	300	108,00
SC05340150	300	108,00
SC05340160	300	108,00
SC05340200	300	149,00
SC05340210	300	149,00
SC05340220	300	149,00
SC05340230	300	149,00
SC05340240	300	149,00
SC05340250	300	149,00
SC05340260	300	149,00
SC05340270	300	149,00
SC05340280	300	149,00
SC05340290	300	149,00
SC05340300	300	149,00
SC05340310	300	149,00
SC05352510	300	108,00
SE00000078	29	16,50
SE00000101	29	24,00
SE00000501	29	14,40
SE00000679	29	31,00

Código	Pág.	P.V.P. (€)
SH00000065	292	45,00
SH000000213	282	80,00
SH000000213	292	80,00
SH000000231	292	58,00
SH000000313	292	81,50
SH000000314	292	40,00
STEX122299	186	105,00
STEX122312	138	64,00
STEX122338	137	80,00
STEX122385	264	36,00
T		
TE00000333	34	0,80
TE00000334	34	0,50
TE00000335	34	0,55
TEB0000006	29	32,00
TK02100200	296	18,55
TK0LDG301G	294	321,00
TK0LM4001F	294	141,00
TK0LM5030F	294	204,00
TRO0000001	379	213,00
UA-1048	310	3,85
UL23-08/C	321	48,00
W		
W15331	280	31,00
W29541	281	4,40
W49625	385	26,30
W5067	281	13,15
W6084	281	5,15
W107402706	281	14,40
W107413540	282	71,00
W107418350	281	33,00
W107418353	283	36,00
W107418355	283	33,00
W107418688	284	28,00
WL00000002	29	9,25
WL00000058	29	77,00
YL00000003	31	38,00
YL00000004	31	44,00
1		
12L	87	30,00
12S	87	22,00
122230-4	138	42,00
122235-4	258	319,00
122296-4	186	13,15
122297-2	186	10,85
122330-0	224	14,95
122335-0	281	14,40
122335-2	281	-
122343-1	264	25,00
122351-2	224	7,95
122354-6	138	14,40
122391-0	264	6,30
122431-4	68	64,00
122446-1	222	27,00
122464-9	126	17,50
122470-4	223	85,00
122472-0	223	5,15
122473-8	259	38,00
122474-6	259	7,10
122520-5	281	8,25
122538-6	223	18,55
122548-3	186	5,45
122562-9	186	13,20
122567-9	223	41,00
122571-8	223	21,90
122591-2	186	11,85
122700-3	264	17,50
122703-7	264	3,50
122707-9	223	16,10
122708-7	71	8,45
122727-3	126	21,00
122728-1	223	16,50
122729-9	223	27,00
122730-4	223	15,45
122739-6	223	116,00
122785-9	137	7,40
122791-4	137	27,00
122793-0	138	17,00
122829-5	69	61,00
122846-5	163	13,05
122852-0	224	3,55
122853-8	168	4,90
122854-6	223	25,00
122867-7	126	6,10
122868-5	126	6,75
122878-2	74	13,10
122889-7	163	8,95
122891-0	163	10,30
122907-1	317	25,00
122911-0	163	8,30
122913-6	163	16,30
122930-6	223	74,00
123004-6	138	3,10

Código	Pág.	P.V.P. (€)
123006-2	138	5,55
123053-3	137	12,90
123062-2	138	2,85
123098-1	163	7,20
123099-9	163	7,75
123101-8	222	14,95
123144-0	163	9,75
123145-8	163	9,10
123146-6	163	11,35
123149-0	259	19,90
123150-5	259	6,55
123199-5	164	22,00
123200-6	164	23,00
123235-7	313	11,35
123241-2	292	8,10
123245-4	292	5,40
123246-2	292	12,60
123488-8	281	10,30
123539-7	281	10,30
123544-4	264	28,00
125052-1	164	11,35
125157-7	185	59,00
125158-5	185	33,00
125159-3	185	80,00
125354-5	298	116,00
125420-8	69	55,00
126617-2	223	28,00
126738-0	170	6,00
126756-8	281	8,45
127069-0	223	46,00
127093-3	281	10,80
127425-4	307	9,80
127501-4	307	8,25
127502-2	307	16,90
127725-2	282	9,00
127750-3	170	13,15
123022-4*	264	13,00
13L	87	31,00
13S	87	22,00
132025-7	292	3,85
132126-1	102	158,00
134182-7	292	10,40
134745-9	124	19,00
134746-7	124	18,55
134803-1	74	28,00
134825-1	123	4,90
134826-9	123	4,90
134827-7	123	6,45
134828-5	123	5,15
134829-3	123	4,90
134830-8	123	4,90
134831-6	123	5,65
134832-4	123	5,65
134833-2	123	7,20
134834-0	123	7,20
134835-8	123	7,70
134836-6	123	8,00
134837-4	123	8,00
134838-2	123	6,20
134839-0	123	8,75
134840-5	123	6,45
134841-3	123	7,70
134842-1	123	8,50
134843-9	123	10,80
134844-7	123	7,70
134845-5	123	11,85
134846-3	123	9,25
134847-1	123	12,35
134848-9	123	9,00
134849-7	123	12,90
134851-0	123	6,45
134853-6	123	11,35
134854-4	123	23,00
134855-2	123	10,30
134856-0	123	21,00
134857-8	123	10,30
134858-6	123	18,00
134859-4	123	18,55
134860-9	123	13,40
134861-7	123	25,00
134862-5	123	14,95
134863-3	123	22,00
134864-1	123	23,00
134865-9	123	22,00
134867-5	123	33,00
134870-6	124	67,00
134871-4	123	10,30
134872-2	123	24,00
134874-8	124	23,00
134877-2	125	66,00
134881-1	74	26,00
134887-9	74	37,00
134889-5	74	20,10

Código	Pág.	P.V.P. (€)
134890-0	74	34,00
134909-5	74	26,00
134915-0	74	28,00
134916-8	74	23,00
134944-3	74	22,00
134945-1	74	28,00
134997-2	124	49,00
134998-0	125	100,00
135197-7	74	20,10
135209-6	74	21,00
135222-4	184	4,60
135246-0	184	4,65
135269-8	74	39,00
135283-4	74	38,00
135302-6	74	3,70
135327-0	184	6,20
135332-7	74	22,00
135380-6	74	23,00
136017-8	70	89,00
136018-6	70	95,00
14L	87	32,00
14S	87	22,00
140073-2	383	72,00
140248-3	282	14,75
140253-0	282	18,50
140441-9	176	4,20
140561-9	382	132,00
140830-8	321	62,00
140G19-0	281	20,70
140G26-3	281	9,20
140H95-0	281	5,15
140J64-3	281	7,60
140Y22-9	170	7,95
140Y23-7	170	6,95
140Y25-3	170	3,65
141354-7	383	29,00
141401-4	383	30,00
141642-2	382	24,00
141736-3	383	57,00
143396-7	221	4,10
143603-8	383	36,00
143787-2	281	30,00
144163-3	185	3,25
15L	87	33,00
15S	87	23,00
150583-1	382	47,00
150589-9	383	58,00
150640-5	382	35,00
150980-1	180	5,15
151517-7*	184	8,25
151749-6	180	5,15
151750-1	180	5,15
151751-9	180	8,00
151776-3	162	10,80
151780-2	184	2,45
152456-4	184	20,10
152491-2	185	2,35
152492-0	162	2,85
152498-8	2	

Código	Pág.	P.V.P. (€)
191C26-2	283	21,05
191C30-1	283	18,60
191C50-5	29	1.777,00
191D12-9	282	11,00
191D34-9	306	36,00
191D39-9	321	160,00
191D63-2	283	18,55
191D71-3	281	39,00
191D76-3	281	5,95
191D79-7	281	4,35
191D91-7	313	17,50
191D92-5	313	17,50
191E07-8	29	160,00
191E19-1	307	69,00
191E27-2	309	118,00
191E39-5	282	10,90
191E43-4	317	13,55
191E54-9	70	160,00
191F24-4	33	72,00
191F46-4	69	51,00
191F47-2	69	32,00
191F49-8	70	49,00
191F78-1	33	27,00
191F79-9	33	27,00
191F80-4	33	57,00
191F81-2	162	49,00
191F95-1	70	113,00
191G00-4	70	113,00
191G06-2	162	81,00
191G67-2	125	129,00
191J13-3	307	9,70
191J39-5	29	479,00
191J50-7	30	124,00
191J51-5	30	180,00
191J59-9	34	371,00
191J65-4	29	386,00
191J81-6	29	505,00
191J97-1	29	695,00
191L00-4	29	196,00
191L14-3	307	6,20
191L24-0	114	95,00
191L29-0	29	191,00
191L47-8	29	314,00
191L91-5	71	5,60
191L96-5	307	10,65
191M20-4	73	63,00
191M27-0	34	185,00
191M48-2	170	51,00
191M50-5	281	54,00
191M56-3	309	510,00
191M75-9	309	464,00
191M78-3	284	9,30
191M79-1	284	9,30
191M90-3	29	93,00
191N09-8	29	258,00
191N23-4	321	30,00
191N24-2	321	22,00
191N62-4	30	155,00
191N90-9	182	9,55
191N91-7	182	11,85
191N92-5	182	11,85
191P11-3	318	143,00
191P72-3	309	159,00
191P89-6	32	89,00
191R02-6	197	11,20
191R51-3	306	45,00
191R52-1	306	73,00
191R54-7	321	155,00
191R55-5	321	155,00
191R56-3	321	170,00
191T38-7	309	180,00
191T43-4	306	15,60
191U00-8	29	711,00
191U13-9	29	803,00
191U86-2	322	25,00
191U88-8	322	35,00
192227-7	164	14,40
192236-6	281	5,65
192282-9	104	31,00
192349-3	250	7,70
192349-3	284	7,70
192439-2	124	154,00
192440-7	124	69,00
192454-6	164	39,00
192505-5	220	29,00
192506-3	220	114,00
192507-1	220	85,00
192523-3	184	21,00
192562-3	281	9,10
192563-1	281	8,65
192613-2	284	14,40
192625-5	223	19,00
192628-9	222	40,00

Código	Pág.	P.V.P. (€)
192629-7	183	19,55
192669-5	222	71,00
192694-6	186	40,00
192732-4	250	8,20
192755-2	319	194,00
192877-8	105	35,00
192985-5	166	14,00
192988-9	166	24,00
192989-7	184	7,20
193011-3	166	23,00
193012-1	166	19,05
193036-7	137	27,00
193055-3	186	81,00
193070-7	186	94,00
193072-3	186	95,00
193141-0	166	64,00
193143-6	166	23,00
193178-7	259	21,00
193180-0	259	24,00
193196-5	382	58,00
193201-8	180	7,30
193202-6	180	4,90
193203-4	104	34,00
193224-6	105	40,00
193226-2	104	33,00
193228-8	105	37,00
193242-4	386	29,40
193243-2	386	22,10
193244-0	386	38,90
193279-1	386	35,70
193280-6	386	29,40
193281-4	386	32,60
193282-2	386	38,90
193283-0	386	24,20
193284-8	386	22,10
193285-6	386	29,40
193293-7	184	7,60
193294-5	184	12,35
193317-9	102	235,00
193318-7	105	48,00
193331-5	261	13,40
193332-3	261	9,55
193334-9	261	10,80
193335-7	261	16,20
193336-5	261	12,35
193338-1	261	12,90
193339-9	261	14,40
193340-4	261	13,40
193386-0	386	14,70
193388-6	386	12,60
193390-9	386	22,10
193391-7	386	29,40
193392-5	386	29,40
193393-3	386	26,30
193394-1	386	13,70
193395-9	386	13,70
193397-5	386	17,90
193399-1	386	50,40
193404-4	386	13,70
193407-8	386	24,20
193448-4	260	24,00
193449-2	260	6,70
193466-2	385	2,40
193472-7	71	46,00
193472-7	285	46,00
193483-2	257	5,15
193516-3	250	9,55
193517-1	250	30,00
193519-7	105	51,00
193521-0	176	28,00
193523-6	176	15,00
193606-2	386	17,90
193618-5	185	33,00
193706-8	105	6,70
193712-3	184	6,25
193730-1	224	3,80
193822-6*	105	26,00
193902-8	137	59,00
193903-6	164	14,95
193904-4	264	46,00
193947-6	31	47,00
193956-5	164	8,50
193976-9	71	13,40
194002-7	222	56,00
194026-3	238	640,00
194074-2	385	1,50
194079-2	69	60,00
194080-7	69	31,00
194086-5	223	34,00
194087-3	223	41,00
194093-8	222	350,00
194160-9	385	3,80
194175-6	224	37,00

Código	Pág.	P.V.P. (€)
194254-0	104	48,00
194267-1	264	15,50
194268-9	264	13,10
194270-2	264	41,00
194281-7	124	28,00
194285-9	385	4,50
194289-1	164	2,05
194330-0	126	24,00
194367-7	220	185,00
194367-7	250	185,00
194367-7	262	185,00
194368-5	220	71,00
194368-5	250	71,00
194368-5	262	71,00
194385-5	221	28,00
194385-5	250	28,00
194385-5	262	28,00
194427-5	385	3,20
194435-6	385	3,80
194500-1	125	83,00
194533-6	29	76,00
194547-5	385	4,40
194566-1	283	3,75
194568-7	69	69,00
194579-2	262	36,00
194581-5	71	13,40
194582-3	71	5,10
194583-1	71	4,80
194588-1	29	47,00
194622-7	29	113,00
194663-3	321	38,00
194666-7	321	44,00
194671-4	321	77,00
194673-0	321	62,00
194678-0	306	2,05
194681-1	306	23,00
194684-5	162	13,80
194691-8	235	21,00
194692-6	235	21,00
194722-3	385	2,00
194733-8	264	2,25
194746-9*	184	5,15
194852-0	274	45,00
194906-3	126	37,00
194921-7	168	7,70
194925-9	220	109,00
194925-9	250	109,00
194925-9	262	109,00
194930-6	176	14,40
194934-8	264	10,80
195050-9	306	37,00
195055-9	137	9,95
195103-4	386	17,90
195105-0	386	15,80
195113-1	386	29,40
195114-9	386	35,70
195136-9	264	53,00
195173-3	71	7,05
195173-3	285	7,05
195176-7	321	49,00
195179-1	71	8,40
195179-1	285	8,40
195187-2	321	58,00
195189-8	386	12,60
195191-1	386	26,30
195193-7	386	7,40
195194-5	386	17,90
195195-3	386	24,20
195199-5	386	17,90
195201-4	386	29,40
195204-8	386	32,60
195205-6	386	35,70
195206-4	386	11,60
195210-3	386	26,30
195239-9	162	49,00
195240-4	222	9,00
195246-2	274	4,40
195258-5	386	13,70
195260-8	386	33,60
195272-1	321	23,00
195299-1	310	21,95
195311-7	30	72,00
195321-4	306	22,00
195333-7	221	3,05
195354-9	164	41,00
195385-8	162	66,00
195423-6	29	53,00
195432-5	283	7,05
195433-3	281	59,00
195434-1	281	59,00
195435-9	281	109,00
195436-7	281	72,00
195437-5	281	47,00

Código	Pág.	P.V.P. (€)
195439-1	281	100,00
195446-4	164	11,35
195511-9	30	130,00
195532-1	169	7,45
195534-7	169	26,00
195545-2	284	6,75
195546-0	284	4,20
195547-8	284	3,15
195548-6	284	8,25
195551-7	281	27,00
195557-5	283	25,00
195559-1	264	3,35
195562-2	263	82,00
195563-0	263	70,00
195564-8	264	6,10
195566-4	309	84,00
195584-2	29	112,00
195595-7	319	190,00
195599-9	169	65,00
195663-6	309	112,00
195717-9	309	268,00
195769-0	321	92,00
195797-5	31	46,00
195798-3	31	48,00
195833-7	386	8,90
195834-5	386	9,50
195844-2	385	3,80
195858-1	313	7,00
195870-1	71	103,00
195898-9	70	114,00
195902-4	70	114,00
196008-1*	105	11,35
196022-7	197	5,15
196066-7	29	57,00
196074-8	72	105,00
196074-8	285	105,00
196122-3	316	2,60
196129-9	317	51,00
196148-5	314	4,85
196152-4	183	24,00
196162-1	70	30,00
196183-3	383	93,00
196185-9	383	99,00
196235-0	29	93,00
196246-5	273	201,00
196278-2	383	98,00
196285-5	272	82,00
196286-3	272	82,00
196287-1	272	82,00
196288-9	272	82,00
196289-7	272	82,00
196290-2	272	76,00
196291-0	272	76,00
196292-8	272	76,00
196293-6	272	76,00
196294-4	272	76,00

Código	Pág.	P.V.P. (€)
198673-2	167	25,00
198688-9	221	187,00
198719-4	164	16,05
198720-9	29	175,00
198751-8	282	4,10
198885-7	220	25,00
198885-7	250	25,00
198885-7	262	25,00
198900-7	31	55,00
198909-9	322	33,00
198915-4	282	7,00
198987-9	263	31,00
198990-0	281	2,20
198992-6	281	2,20
198993-4	69	6,20
199008-0	324	181,00
199009-8	324	209,00
199010-3	296	12,90
199041-2	281	7,20
199067-4	305	3,00
199075-5	304	12,95
199083-6	217	68,00
199085-2	217	68,00
199087-8	217	68,00
199098-3	321	103,00
199099-1	321	103,00
199137-9	34	188,00
199138-7	69	22,00
199139-5	69	51,00
199140-0	220	45,00
199140-0	250	45,00
199140-0	262	45,00
199142-6	72	100,00
199142-6	285	100,00
199155-7	114	44,00
199168-8	320	98,00
199169-6	320	123,00
199178-5	296	10,30
199231-7	221	8,85
199232-5	220	52,00
199318-5	309	544,00
199339-7	309	570,00
199386-8	221	15,65
199388-4	281	59,00
199424-6	183	26,00
199439-3	281	3,80
199453-9	281	16,45
199454-7	281	29,00
199455-5	281	29,00
199491-1	281	36,00
199493-7	281	18,65
199514-5	164	26,00
199557-7	70	11,00
199581-0	70	145,00
199585-2	70	145,00
199596-7	70	8,75
199624-8	197	8,25
199627-2	197	10,75
199664-6	70	91,00
199687-4	29	113,00
199709-0	163	9,40
199710-5	163	9,90
199725-2	33	27,00
199728-6	33	33,00
199729-4	33	34,00
199730-9	33	14,40
199731-7	33	14,40
199773-1	283	232,00
199872-9	310	25,00
199874-5	310	38,00
199897-3	319	4,10
199937-7	185	175,00
199938-5	179	59,00
199939-3	179	54,00
199940-8	179	61,00
199966-0	282	6,75
199971-7	281	5,25
2		
20L	87	41,00
20S	87	27,00
21L	87	44,00
21S	87	28,00
213397-0	123	1,00
213398-8	123	1,00
213399-6	123	1,00
213461-7	123	1,00
213514-2	123	1,00
213570-2	123	1,00
22L	87	44,00
22S	87	29,00
221502-5	258	17,00
224415-9	163	1,50
224515-5	179	5,15

Código	Pág.	P.V.P. (€)
224543-0	163	1,95
23L	87	46,00
23S	87	30,00
24L	87	48,00
24S	87	31,00
242075-5	274	19,55
242077-1	274	10,80
242088-6	274	14,40
242094-1	274	16,50
25L	87	50,00
25S	87	35,00
252627-4	261	10,30
256282-4	123	1,00
256283-2	123	1,00
256284-0	123	1,00
256812-1	222	24,00
257022-3	224	0,80
257060-5	224	1,30
257262-3	224	0,80
26L	87	53,00
26S	87	36,00
262542-4	185	2,20
266491-7	264	2,05
268056-1	123	1,00
268057-9	123	1,00
27L	87	56,00
27S	87	37,00
273457-0	74	10,80
273472-4	74	10,30
273496-0	74	11,35
28L	87	57,00
28S	87	42,00
29L	87	60,00
29S	87	43,00
3		
30L	87	63,00
30S	87	44,00
31L	87	65,00
31S	87	45,00
313248-8	197	2,60
32L	87	68,00
32S	87	46,00
321492-3	261	15,45
321812-1	261	10,05
322119-8	126	18,55
322120-3	126	8,00
322124-5	126	12,35
322125-3	126	12,90
322126-1	126	13,90
322177-4	102	1,10
322932-4	222	6,50
324149-5	260	11,00
324219-0	102	1,85
327095-1	222	5,50
327684-2	318	31,00
327685-0	318	36,00
327687-6	318	27,00
33L	87	73,00
33S	87	47,00
34L	87	74,00
34S	87	49,00
341705-6	180	3,35
341796-7	298	1,05
342328-3	180	2,85
342332-2	186	3,85
342390-8	137	2,05
342428-9	264	6,85
343411-9	59	29,00
343411-9	68	29,00
343433-9	136	3,60
343577-5	261	0,75
344364-5	261	2,60
344586-7	180	2,60
344620-3	180	2,15
35L	87	77,00
35S	87	53,00
36L	87	80,00
36S	87	52,00
369224790	314	2,60
369224791	314	10,80
369224792	314	3,35
369224793	314	11,05
369224794	314	29,00
369224795	314	3,85
369224796	314	11,05
369224797	314	29,00
369224798	314	4,90
369224799	314	13,15
369224800	314	33,00
369224801	314	52,00
369224802	314	5,40
369224803	314	13,15
369224804	314	34,00

Código	Pág.	P.V.P. (€)
369224805	314	52,00
369224807	314	2,15
369224808	314	2,45
369224809	314	4,10
369224810	314	4,65
369224811	314	11,05
369224812	314	11,05
369224815	314	29,00
369224816	314	29,00
369224819	314	4,90
369224820	314	4,90
369224821	314	11,05
369224822	314	11,05
369224823	314	11,05
369224824	314	11,05
369224825	314	29,00
369224826	314	29,00
369224827	314	29,00
369224828	314	29,00
37L	87	83,00
37S	87	54,00
38L	87	84,00
38S	87	58,00
381224230	310	5,65
381224240	313	17,25
382224300	313	19,55
382224310	310	7,70
384224270	313	23,00
385224150	310	25,00
385224240	313	17,25
385224250	310	8,75
39L	87	93,00
39S	87	59,00
394114272	170	60,00
4		
40L	87	98,00
40S	87	67,00
41L	87	102,00
41S	87	68,00
410047-0	168	0,75
410306-2	281	3,40
412088-2	167	3,30
413094-0	184	1,30
413101-9	220	4,10
413102-7	220	15,45
413148-3	263	4,50
413150-6	263	2,50
415412-8	264	5,00
415452-6	138	3,45
415486-9	102	0,90
415524-7	250	0,75
415579-2	259	7,50
416041-0	281	1,30
416348-4	185	10,40
416368-8	138	2,05
416477-3	250	0,50
416772-1	224	4,05
417113-4	223	0,60
417322-5	168	7,60
417322-5	185	7,60
417671-0	185	16,85
417852-6	250	2,60
417853-4	250	1,05
418529-6	185	3,00
419242-9	305	2,80
419288-5	305	*
419525-7	273	1,45
42L	87	104,00
42S	87	69,00
421093-8	180	4,10
421342-3	71	2,30
421646-3	180	2,60
421648-9	180	3,50
421664-1	71	3,60
422440-6	282	0,50
422449-8	282	2,75
423029-3	180	2,80
423035-8	180	3,85
423036-6	180	2,20
423149-3	180	2,60
423154-0	71	0,75
423312-8	180	2,05
423313-6	180	2,60
423315-2	180	2,35
423316-0	180	2,85
423359-2	220	5,65
423360-7	220	11,00
423361-5	220	6,70
423362-3	220	15,45
423386-9	220	8,25
423390-8	220	9,25
423398-2	282	9,25
43L	87	107,00

Código	Pág.	P.V.P. (€)
43S	87	71,00
44L	87	111,00
44S	87	73,00
443060-3	282	1,00
443122-7	69	3,05
45L	87	124,00
45S	87	74,00
450066-4	184	0,90
450770-5	184	2,40
450819-1	263	3,00
450963-4	126	1,80
450967-6	126	1,20
450968-4	126	1,20
451208-3	282	1,80
451241-5	281	2,15
451243-1	281	0,80
451244-9	281	4,05
451330-6	220	6,20
451424-7	281	2,20
451753-8	307	4,10
452055-5	321	2,40
452093-7	305	1,90
452123-4	307	12,35
453378-4	185	9,75
453974-8	381	0,60
454226-0	32	3,85
454407-6	31	4,65
454842-8	263	2,40
454896-5	307	7,70
455288-1	185	2,85
455291-2	185	8,80
455591-0	126	1,75
455634-8	307	13,15
456586-6	281	1,10
456587-4	281	1,95
458184-2	281	-
458342-0	321	4,00
458467-0	282	0,50
459056-4	281	2,50
459353-8	281	2,30
459356-2	281	2,30
459937-2	31	6,20
459938-0	31	7,70
46L	87	128,00
46S	87	82,00
47L	87	136,00
47S	87	84,00
48L	87	141,00
48S	87	85,00
49L	87	143,00
49S	87	88,00
5		
50L	87	145,00
50S	87	90,00
501035	103	25,00
501036	103	10,30
501037	103	4,40
501038	103	4,65
501043	103	185,00
501329	102	34,00
501353	103	162,00
502024	61	36,00
502026	61	46,00
503174	186	13,90
511291756	304	14,15
511492740	304	13,40
511492752	304	13,65
511492756	304	14,15
512466760	304	18,00
6		
699020-5	126	12,55

Código	Pág.	P.V.P. (€)
792536-0	298	45,00
792537-8	298	76,00
792556-4	235	23,00
792558-0	235	37,00
792559-8	235	37,00
792560-3	235	37,00
792567-9	235	37,00
792728-1	298	27,00
793061-4	254	32,00
793346-8	136	39,00
794050-2	161	1,30
794051-0	161	1,30
794053-6	161	1,30
794059-4	161	2,85
794060-9	138	12,90
794061-7	138	10,80
794173-6	183	12,35
794176-0	183	22,00
794379-6	134	153,00
794381-9	134	194,00
794383-5	134	156,00
794384-3	134	164,00
794530-8	320	12,35
794558-6	183	24,00
794560-9	183	22,00
794618-4	183	18,50
798035-0	64	92,00
798312-0	114	2,05
798385-3	66	203,00
8		
80051B5X	385	12,60
821549-5	380	31,00
821550-0	380	34,00
821551-8	381	37,00
821552-6	381	48,00
821568-1	383	63,00
821604-3	382	56,00
821608-5	383	23,00
821620-5	383	29,00
821621-3	383	23,00
821661-1	383	16,70
821663-7	383	21,00
821670-0	383	51,00
821691-2	383	21,00
821710-4	383	32,00
821717-0	383	58,00
821734-0	383	36,00
821796-8	383	37,00
821837-0	383	43,00
821841-9	382	52,00
823256-6	382	24,00
824491-9	383	37,00
824519-3	383	64,00
824523-2	382	40,00
824550-9	383	20,10
824555-9	382	46,00
824564-8	382	69,00
824572-9	382	11,85
824581-8	382	12,35
824593-1	382	35,00
824607-6	383	63,00
824635-1	382	10,85
824646-6	382	44,00
824652-1	382	9,80
824690-3	382	36,00
824695-3	382	15,40
824695-3	383	15,40
824698-7	382	28,00
824702-2	383	20,05
824703-0	383	15,10
824707-2	383	15,45
824708-0	382	39,00
824723-4	382	17,00
824724-2	383	18,00
824728-4	382	45,00
824737-3	383	56,00
824756-9	382	22,00
824757-7	382	30,00
824760-8	382	23,00
824767-4	382	19,55
824789-4	382	17,75
824799-1	383	25,00
824806-0	382	13,55
824808-6	382	34,00
824811-7	383	17,80
824819-1	383	55,00
824820-6	382	47,00
824825-6	383	64,00
824842-6	382	11,45
824852-3	382	14,15
824863-8	382	53,00
824875-1	382	50,00
824882-4	382	146,00

Código	Pág.	P.V.P. (€)
824890-5	382	15,45
824892-1	383	15,40
824898-9	383	142,00
824904-0	382	74,00
824905-8	382	71,00
824908-2	382	102,00
824958-7	382	29,00
824981-2	382	18,60
824990-1	382	58,00
824998-5	383	21,00
835A34-8	380	3,80
835B51-4	380	3,85
835C84-5	381	3,00
835D35-4	381	4,35
835E79-0	381	3,00
835F93-2	381	2,95
835F94-0	381	3,05
835K82-7	381	3,80
835K85-1	381	3,80
835L10-8	380	3,55
835P86-9	380	4,20
835R29-3	380	3,85
837247-1	381	8,20
837628-9	381	8,50
837630-2	380	8,45
837631-0	381	7,65
837632-8	381	8,15
837634-4	381	9,00
837636-0	380	7,10
837639-4	380	11,35
837640-9	380	9,30
837642-5	381	9,00
837644-1	380	8,45
837645-9	381	8,25
837646-7	380	8,15
837647-5	381	8,20
837648-3	381	7,70
837649-1	381	8,20
837650-6	381	8,50
837651-4	380	8,10
837652-2	381	8,25
837653-0	381	8,20
837654-8	381	8,70
837655-6	381	8,45
837657-2	381	9,60
837658-0	381	7,70
837659-8	381	7,70
837660-3	380	8,50
837661-1	381	11,45
837662-9	380	15,20
837664-5	380	8,20
837670-0	380	12,10
837671-8	381	8,10
837672-6	380	4,35
837673-4	380	8,15
837674-2	380	8,75
837675-0	380	8,40
837678-4	381	12,00
837695-4	380	9,55
837789-5	381	6,95
837803-7	380	7,70
837805-3	380	7,70
837806-1	380	7,70
837807-9	381	8,00
837808-7	381	7,70
837809-5	380	7,70
837861-3	381	17,45
837864-7	381	5,45
837866-3	380	8,20
837869-7	380	7,95
837870-2	380	7,55
837874-4	380	10,60
837897-2	380	5,45
837916-4	380	9,05
837945-7	381	7,70
837988-9	381	9,30
838023-6	381	7,35
838024-4	380	10,55
838025-2	380	10,60
838026-0	381	8,75
838039-1	380	8,15
838040-6	380	7,35
838108-8	381	5,65
838109-6	381	8,50
838111-9	381	8,25
838175-3	381	10,05
838182-6	381	10,15
838246-6	381	5,50
838312-9	380	6,55
838314-5	381	4,90
838315-3	381	6,80
838390-9	381	9,90
838683-4	380	6,20

Código	Pág.	P.V.P. (€)
839128-5	381	8,45
839186-1	380	5,15
839205-3	381	5,20
839214-2	380	5,20
839245-1	380	4,95
839387-1	381	5,25
839458-4	381	7,30
839523-9	381	4,35
839559-8	381	4,30
839751-6	381	4,90
839752-4	381	5,15
839891-0	381	5,20
9		
941713001	306	2,30
941716132	306	2,85
941719133	306	2,85
952010640	305	4,90
953003040	306	2,15
953003060	306	6,45
953003070	306	2,15
953003090	306	2,15
953003090	319	2,15
953003110	306	2,15
953004010	306	2,30
953009000	306	13,90
953003010	306	14,95
953100090	306	6,20
957173190	169	19,00
957800410	385	7,10
957802410	385	6,80
957802600	169	406,00
980008103	316	11,85
980008106	316	1,90
980008107	316	6,70
980008112	316	11,35
980008118	316	31,00
980008120	316	4,10
980008121	316	7,70
980008125	316	9,25
980008210	316	5,95
980008211	316	29,00
988000040	317	27,00
988002256	316	4,40
988002258	316	18,55

NORTE

ASSEADA

R. Presa Rei, 209, Carregosa
3720 OLIVEIRA AZEMÉIS
Tel.: 256 412 357
www.asseada.com

BRICOFEL

Z. Ind. Cantarias, Lt. 167
5300 BRAGANÇA
Tel.: 273 312 371
www.bricofel.com

CENTRO

ABR

R. Casal Frazão, S/N
2025 AMIAIS BAIXO
Tel.: 249 870 716
www.abr.pt

AGROSPORT

Est. Várzeas Casal 3, Pinheiros
2070 CARTAXO
Tel.: 243 770 514
www.agrosport.pt

BENEMÁQUINA

R. Monges de Cister, 10 A
2475 BENEDITA
Tel.: 262 921 359

AÇORES

ELETROXI

R. Juventude, 17 R/C Left.
9500 ILHA SÃO MIGUEL
Tel.: 291 930 380

MADEIRA

SOMATERIAL

Caminho Igreja, 36, Caniço
9125 FUNCHAL
Tel.: 291 930 380

JMM

R. da Boavista, 40, Lordelo
4816 GUIMARÃES
Tel.: 252 840 510
www.jmm.pt

MACHADO & CARDOSO

R. Prof. Dr. José Azevedo Ferreira, 38, Maximinos
4701 BRAGA
Tel.: 253 617 883
www.machadoecardoso.pt

BOBINADORA POMBALENSE

Estrada Nacional, 1, Moncalva
3100 POMBAL
Tel.: 236 209 970

MAQUIVEDRAS

Av. June 10, 73-75
2565 TORRES VEDRAS
Tel.: 261 950 060

PARAMAQUINAS

Lugar do Brejo, Est. Ponte, Fração C,
Antanho
3040 COIMBRA
Tel.: 239 442 059
www.paramaquinas.com

LOS LIVE OUR STYLE

R. Serpa Pinto, 41, Horta
9990 FAIAL
Tel.: 292 391 990

OXIBEIRAS

R. Municipal Stadium, 6 R/C
6300 GUARD
Tel.: 271 222 788
www.oxibeiras.pt

VHS

R. da Gandarra, 1223, Touginho
4480 VILA DO CONDE
Tel.: 252 684 560
www.vhs.pt

OLEIREP OLEIROS

R. Mons. Romão, 8
6160-426
Oleiros
Tel.: 272 681 100
www.oleirep.com

OLEIREP SERTÃ

R. 1º December,
Outeiro, 25
6100-743 SERTÃ
Tel.: 274 098 006

OLEIREP PROENÇA-A-NOVA

R. St. Cruz, 123,
6150-424 PROENÇA-A-NOVA
Phone: 272 681 100

TERCEIRA FARMA

Pico Redondo, 145,
Praia Vitória
9700
TERCEIRA Tel.: 295 512 509
www.terceirafarma.com

Go Green with MAKITA

Makita TECHNOLOGIES LIT XGT CXT BL MOTOR XPT AVT AWS SAR DXT



www.makita.pt



Catálogo
ACESSÓRIOS
2022

Centro Emp. Alverca, Armazém C2, C3, C4

Vale das Ervas

2615-153 ALVERCA PORTUGAL

Tel. +351 219 936 750 | email: Customer.service@makita.pt